

## Operator's Manual



# optris<sup>®</sup> CSlaser

LT/ hs LT/ 2M/ G5

**Infrared-thermometer**

**Optris GmbH**

Ferdinand-Buisson-Str. 14  
13127 Berlin  
Germany

Tel.: +49 30 500 197-0  
Fax: +49 30 500 197-10

E-mail: [info@optris.global](mailto:info@optris.global)  
Internet: [www.optris.global](http://www.optris.global)



# Table of Contents

<b>Table of Contents .....</b>	<b>3</b>
<b>1 General Information .....</b>	<b>7</b>
1.1 Description .....	7
1.2 Warranty .....	8
1.3 Scope of Supply .....	8
1.4 Maintenance .....	9
1.5 Model Overview .....	9
1.6 Factory Default Settings .....	10
<b>2 Technical Data .....</b>	<b>12</b>
2.1 General Specifications .....	12
2.2 Electrical Specifications .....	13
2.3 Measurement Specifications .....	14
2.4 Optical Charts .....	17

<b>3</b>	<b>Mechanical Installation</b> .....	<b>26</b>
<b>4</b>	<b>Accessories</b> .....	<b>27</b>
4.1	Mounting Brackets.....	27
4.2	Air Purge Collar .....	28
4.3	Water Cooled Housing .....	29
4.4	CoolingJacket Advanced.....	30
4.5	Outdoor protective housing .....	31
<b>5</b>	<b>Electrical Installation</b> .....	<b>32</b>
5.1	Cable Connections .....	32
5.2	Analog Mode .....	35
5.3	Digital Mode .....	35
5.4	Digital and Analog Mode combined .....	36
5.5	Maximum Loop Impedance .....	37
<b>6</b>	<b>Emissivity Setting</b> .....	<b>38</b>

<b>7</b>	<b>Laser Sighting .....</b>	<b>39</b>
<b>8</b>	<b>IRmobile app.....</b>	<b>41</b>
<b>9</b>	<b>Software CompactConnect .....</b>	<b>43</b>
9.1	Installation .....	43
9.2	Communication Settings .....	45
9.3	Digital Command Set .....	46
<b>10</b>	<b>Basics of Infrared Thermometry.....</b>	<b>47</b>
<b>11</b>	<b>Emissivity .....</b>	<b>48</b>
11.1	Definition.....	48
11.2	Determination of unknown Emissivities.....	48
11.3	Characteristic Emissivities.....	49
	<b>Appendix A – Emissivity Table Metals .....</b>	<b>50</b>
	<b>Appendix B – Emissivity Table Non Metals .....</b>	<b>52</b>
	<b>Appendix C – Smart Averaging.....</b>	<b>53</b>

**Appendix D - Declaration of Conformity .....54**

# 1 General Information

## 1.1 Description

Thank you for choosing the **optris® CSlaser** infrared thermometer.

The sensors of the optris CSlaser series are noncontact infrared temperature sensors.

They calculate the surface temperature based on the emitted infrared energy of objects [**► 10 Basics of Infrared Thermometry**]. An integrated double laser aiming helps to mark the measurement spot on the object surface. This lies within the two laser points.

The sensor housing of the CSlaser head is made of stainless steel (IP65/ NEMA-4 rating).



The CSlaser sensing head is a sensitive optical system. Please use only the thread for mechanical installation.



- Avoid abrupt changes of the ambient temperature.
- Avoid mechanical violence on the head – this may destroy the system (expiry of warranty).
- If you have any problems or questions, please contact our service department.



Read the manual carefully before the initial start-up. The producer reserves the right to change the herein described specifications in case of technical advance of the product.



► All accessories can be ordered according to the referred part numbers in brackets [ ].

## 1.2 Warranty

Each single product passes through a quality process. Nevertheless, if failures occur please contact the customer service at once. The warranty period covers 24 months starting on the delivery date. After the warranty is expired the manufacturer guarantees additional 6 months warranty for all repaired or substituted product components. Warranty does not apply to damages, which result from misuse or neglect. The warranty also expires if you open the product. The manufacturer is not liable for consequential damage or in case of a non-intended use of the product.

If a failure occurs during the warranty period the product will be replaced, calibrated or repaired without further charges. The freight costs will be paid by the sender. The manufacturer reserves the right to exchange components of the product instead of repairing it. If the failure results from misuse or neglect the user has to pay for the repair. In that case you may ask for a cost estimate beforehand.

## 1.3 Scope of Supply

- CSlaser
- Mounting nut and mounting bracket (fixed)
- Connection cable (optional at connector version)
- Operators manual



## 1.4 Maintenance

**Lens cleaning:** Blow off loose particles using clean compressed air. The lens surface can be cleaned with a soft, humid tissue (moistened with water) or a lens cleaner (e.g. Purosol or B+W Lens Cleaner).



Never use cleaning compounds which contain solvents (neither for the lens nor for the housing).

## 1.5 Model Overview

The sensors of the CSLaser series are available in the following basic versions:

Model	Model code	Measurement range	Spectral response	Typical applications
CSLaser	LT	-30 to 1000 °C	8-14 µm	non-metallic surfaces
	hs LT	-20 to 150 °C		0,025 K resolution
CSLaser 2M	2ML	250 to 800 °C	1,6 µm	metals and ceramic surfaces
	2MH	385 to 1600 °C		
CSLaser G5	G5L G5H G5HF G5H1F	100 to 1200 °C 250 to 1650 °C 200 to 1450 °C 400 to 1650 °C	5,0 µm	glass

**In the following chapters of this manual you will find only the short model codes.**

## 1.6 Factory Default Settings

The unit has the following presetting at time of delivery:

Signal output object temperature	4-20 mA					
Emissivity (switches)	0,970 [LT, hs LT] 1,000 [2ML, 2MH, G5HF, G5H1F]					
Emissivity (via software)	1,000					
Transmissivity	1,000					
Average time (AVG)	0,2 s [LT, hs LT] 0,1 s [2ML, 2MH, G5HF, G5H1F]					
Smart Averaging	inactive [LT] active [hs LT, 2ML, 2MH, G5HF, G5H1F]					
Peak hold	inactive					
Valley hold	inactive					
	<b>LT</b>	<b>hs LT</b>	<b>2ML</b>	<b>2MH</b>	<b>G5HF</b>	<b>G5H1F</b>
Lower limit temperature range [°C]	0	-20	250	385	200	400
Upper limit temperature range [°C]	500	150	800	1600	1450	1650
Lower limit signal output	4 mA					
Upper limit signal output	20 mA					
Temperature unit	°C					
Ambient temperature compensation	internal head temperature probe					
Laser	active					



**Smart Averaging** means a dynamic average adaptation at high signal edges.

[Activation via software only].

► **Appendix C – Smart Averaging**

## 2 Technical Data

### 2.1 General Specifications

Environmental rating	IP65 (NEMA-4)
Ambient temperature <sup>1)</sup>	-20...85 °C
Storage temperature	-40...85 °C
Relative humidity	10...95 %, non condensing
Material	stainless steel
Dimensions	100 mm x 50 mm, M48x1,5
Weight	600 g
Cable length (on connector version only)	3 m, 8 m, 15 m
Cable diameter	5 mm
Ambient temperature cable	max. 105 °C [High temperature cable (optional): 180 °C]
Vibration	IEC 68-2-6: 3G, 11 – 200Hz, any axis
Shock	IEC 68-2-27: 50G, 11ms, any axis
Software (optional)	CompactConnect

<sup>1)</sup> Laser will turn off automatically at ambient temperatures >50 °C.

## 2.2 Electrical Specifications

Power Supply	5–30 VDC
Current draw (laser)	45 mA @ 5 V 20 mA @ 12 V 12 mA @ 24 V
Aiming laser	635 nm, 1 mW, On/ Off via external switch (needs to be installed by user before start-up) or software
Output/ analog	4–20 mA current loop
Alarm output	Programmable open collector output at RxD pin [0-30 V/ 500 mA]
Output impedance	max. loop resistance 1000 $\Omega$ (in dependence on supply voltage)
Output/ digital	uni-/ bidirectional, 9,6 kBaud, 0/3 V digital level USB optional

## 2.3 Measurement Specifications

	LT	hs LT
Temperature range (scalable)	-30...1000 °C	-20...150 °C
Spectral range	8...14 μm	
Optical resolution	50:1	
System accuracy <sup>1), 2)</sup>	±1,0 °C or ±1,0 %	
Repeatability <sup>1), 2)</sup>	±0,5 °C or ±0,5 %	±0,3 °C or ±0,3 %
Thermal sensitivity (NETD)	0,1 K <sup>2)</sup>	0,025 K <sup>4)</sup>
Response time (90% signal)	150 ms	
Warm-up time	10 min	
Emissivity/ Gain	0,100...1,100 (adjustable via switches on sensor or via software)	
IR window correction	0,100...1,100 (adjustable via software)	
Signal processing	Average, peak hold, valley hold, extended hold functions with threshold and hysteresis (adjustable via software)	

<sup>1)</sup> at ambient temperature 23±5 °C; whichever is greater

<sup>2)</sup> at object temperatures >0 °C

<sup>3)</sup> ε = 1/ Response time 1 s

<sup>4)</sup> at T<sub>obj</sub> >20°C and time constant > 0,2 s

	2ML	2MH
Temperature range (scalable)	250...800 °C	385...1600 °C
Spectral range	1,6 μm	
Optical resolution	150:1	300:1
System accuracy <sup>1)</sup>	±(0,3 % of reading +2 °C) <sup>3)</sup>	
Repeatability <sup>1)</sup>	±(0,1 % of reading +1 °C) <sup>3)</sup>	
Thermal sensitivity (NETD)	0,1 K <sup>2)</sup>	
Emissivity/ Gain	0,100...1,100 (adjustable via switches on sensor or via software)	
IR window correction	0,100...1,100 (adjustable via software)	
Signal processing	Average, peak hold, valley hold, extended hold functions with threshold and hysteresis (adjustable via software)	

<sup>1)</sup> at ambient temperature 23±5 °C; whichever is greater

<sup>2)</sup> at object temperatures >0 °C

<sup>3)</sup> ε = 1/ Response time 1 s

	G5L	G5H	G5HF	G5H1F
Temperature range (scalable)	100...1200 °C	250...1650 °C	200...1450 °C	400...1650 °C
Spectral range	5,0 µm			
Optical resolution	45:1	70:1	45:1	
System accuracy <sup>1), 2), 3)</sup>	±1,5 °C or ±1 %			
Repeatability <sup>1), 2), 3)</sup>	±0,5 °C or ±0,5 %			
Thermal sensitivity (NETD)	0,1 K <sup>2)</sup>			
Response time (90% signal)	120 ms	80 ms	30 ms	
Warm-up time	10 min			
Emissivity/ Gain	0,100...1,100 (adjustable via switches on sensor or via software)			
IR window correction	0,100...1,100 (adjustable via switches on sensor or via software)			
Signal processing	Average, peak hold, valley hold, extended hold functions with threshold and hysteresis (adjustable via software)			

<sup>1)</sup> at ambient temperature 23±5 °C; whichever is greater

<sup>2)</sup> at object temperatures >0 °C

<sup>3)</sup>  $\varepsilon = 1 / \text{Response time } 1 \text{ s}$



## 2.4 Optical Charts

The following optical charts show the diameter of the measuring spot in dependence on the distance between measuring object and sensing head. The spot size refers to 90 % of the radiation energy. The distance is always measured from the front edge of the sensing head.



The size of the measuring object and the optical resolution of the infrared thermometer determine the maximum distance between sensing head and measuring object.

In order to prevent measuring errors the object should fill out the field of view of the optics completely.

Consequently, the spot should at all times have at least **the same size** like the object or should be **smaller than** that.

As an alternative to the optical diagrams, the [spot size calculator](#) can also be used on the Optris website or via the Optris [calculator app](#). The app can be downloaded for free from the Google Play store (see QR code).

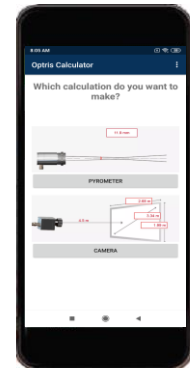

**D** = Distance from front of the sensing head to the object  
**S** = Spot size

**LT**

**Optics: SF**

**D:S (focus distance) = 50:1/ 24mm@ 1200mm**  
**D:S (far field) = 20:1**

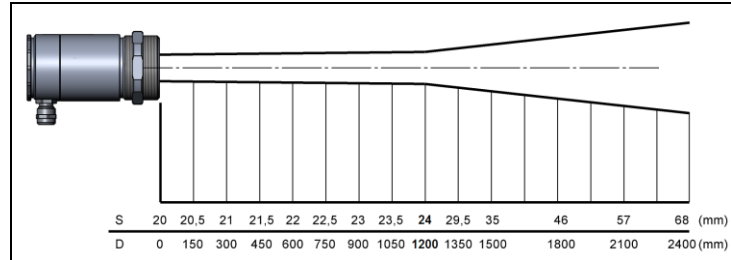

**LT**

**Optics: CF1**

**D:S (focus distance) = 50:1/ 1,4mm@ 70mm**  
**D:S (far field) = 1,5:1**

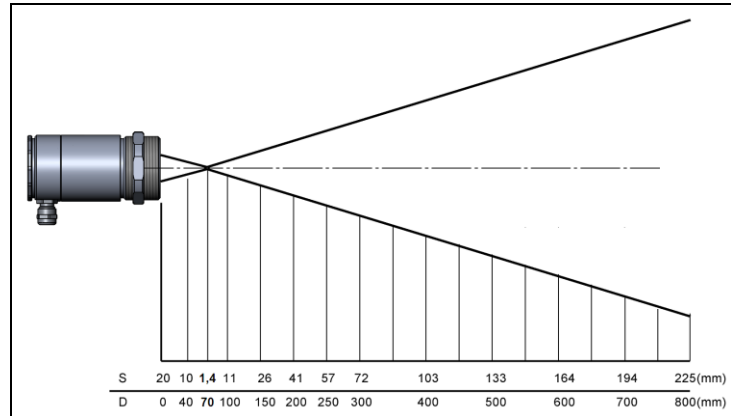

**LT**

**Optics: CF2**

**D:S (focus distance) = 50:1/ 3mm @ 150mm**

**D:S (far field) = 6:1**

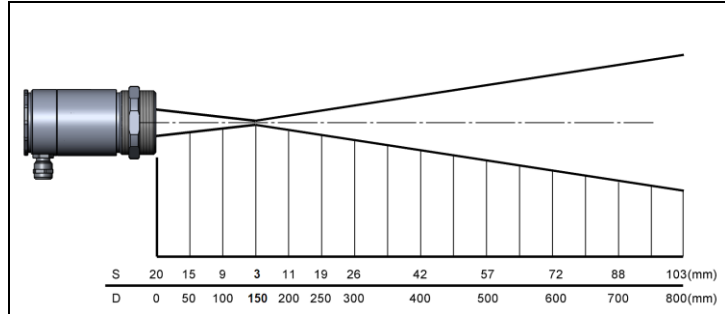

**LT**

**Optics: CF3**

**D:S (focus distance) = 50:1/ 4mm @ 200mm**

**D:S (far field) = 8:1**

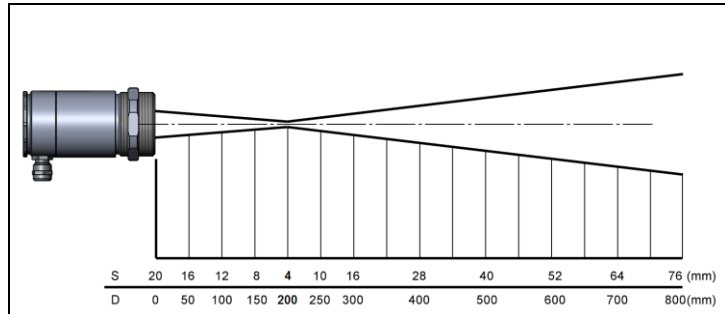

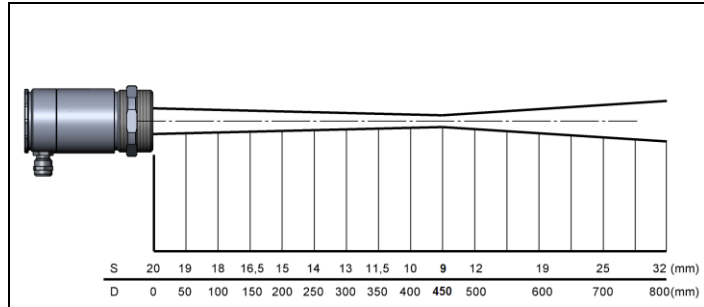
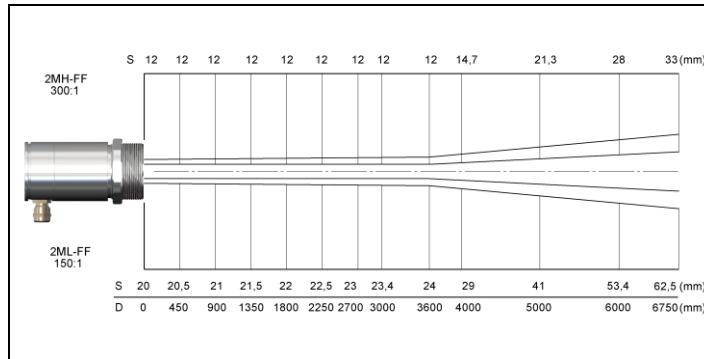
**LT****Optics: CF4****D:S (focus distance) = 50:1/ 9mm @ 450mm****D:S (far field) = 16:1****2MH****Optics: FF****D:S (focus distance) = 300:1****12mm @ 3600mm****D:S (far field) = 115:1****2ML****Optics: FF****D:S (focus distance) = 150:1****24mm @ 3600mm****D:S (far field) = 84:1**

**2MH**

Optics: SF

D:S (focus distance) = 300:1  
 3,7mm @ 1100mm  
 D:S (far field) = 48:1

**2ML**

Optics: SF

D:S (focus distance) = 150:1  
 7,3mm @ 1100mm  
 D:S (far field) = 42:1

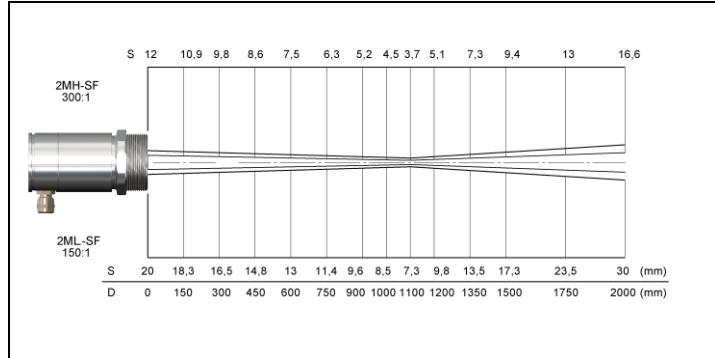

**2MH**

Optics: CF2

D:S (focus distance) = 300:1  
 0,5mm @ 150mm  
 D:S (far field) = 7,5:1

**2ML**

Optics: CF2

D:S (focus distance) = 150:1  
 1,0mm @ 150mm  
 D:S (far field) = 7:1

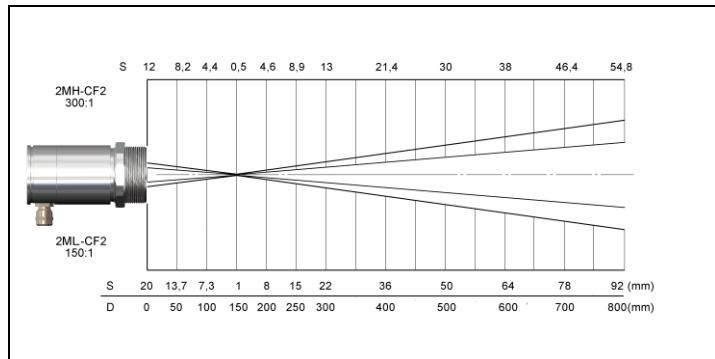

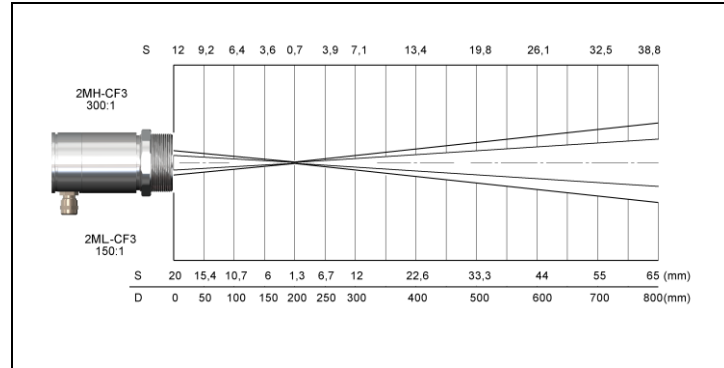
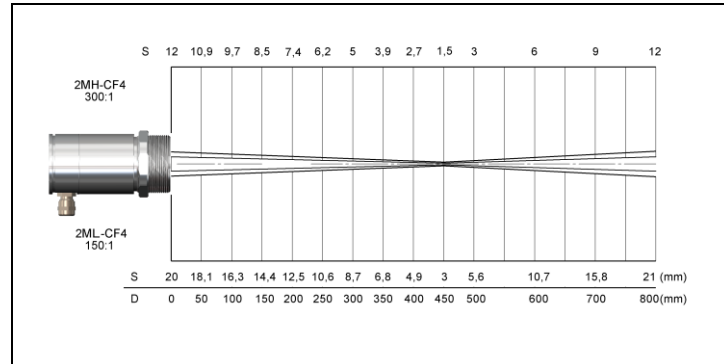
**2MH****Optics: CF3****D:S (focus distance) = 300:1****0,7mm @ 200mm****D:S (far field) = 10:1****2ML****Optics: CF3****D:S (focus distance) = 150:1****1,3mm @ 200mm****D:S (far field) = 10:1****2MH****Optics: CF4****D:S (focus distance) = 300:1****1,5mm @ 450mm****D:S (far field) = 22:1****2ML****Optics: CF4****D:S (focus distance) = 150:1****3,0mm @ 450mm****D:S (far field) = 20:1**

**G5L/ G5HF/ G5H1F**

Optics: SF

D:S (focus distance) = 45:1/ 27mm @1200mm

D:S (far field) = 25:1

**G5H**

Optics: SF

D:S (focus distance) = 70:1/ 17mm @1200mm

D:S (far field) = 33:1

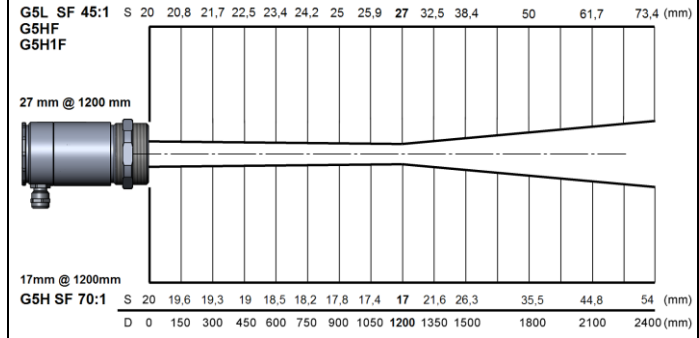

**G5L/ G5HF/ G5H1F**

Optics: CF1

D:S (focus distance) = 45:1/ 1,6mm @70mm

D:S (far field) = 3:1

**G5H**

Optics: CF1

D:S (focus distance) = 70:1/ 1mm @70mm

D:S (far field) = 3,4:1

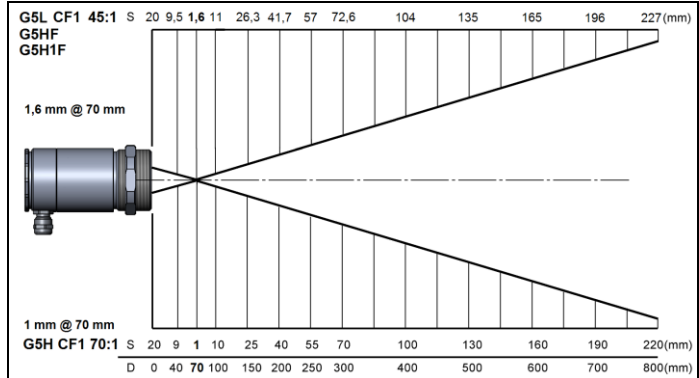

**G5L/ G5HF/ G5H1F**

Optics: CF2

D:S (focus distance) = 45:1/ 3,4mm@150mm

D:S (far field) = 6:1

**G5H**

Optics: CF2

D:S (focus distance) = 70:1/ 2,2mm@150mm

D:S (far field) = 6,8:1

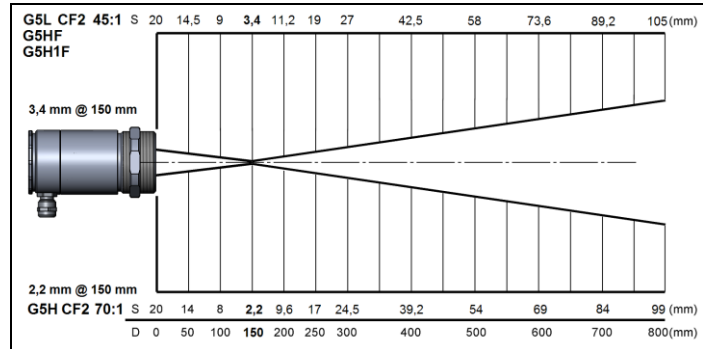
**G5L/ G5HF/ G5H1F**

Optics: CF3

D:S (focus distance) = 45:1/ 4,5mm@200mm

D:S (far field) = 8:1

**G5H**

Optics: CF3

D:S (focus distance) = 70:1/ 2,9mm@200mm

D:S (far field) = 9,2:1

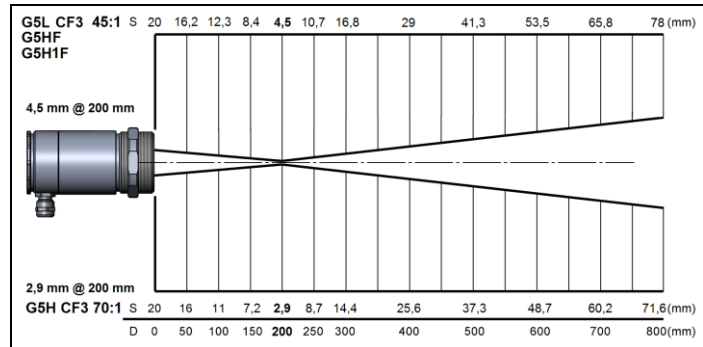



**G5L/ G5HF/ G5H1F**

Optics: CF4

D:S (focus distance) = 45:1/ 10mm @450mm

D:S (far field) = 15:1

**G5H**

Optics: CF4

D:S (focus distance) = 70:1/ 6,5mm @450mm

D:S (far field) = 17,7:1

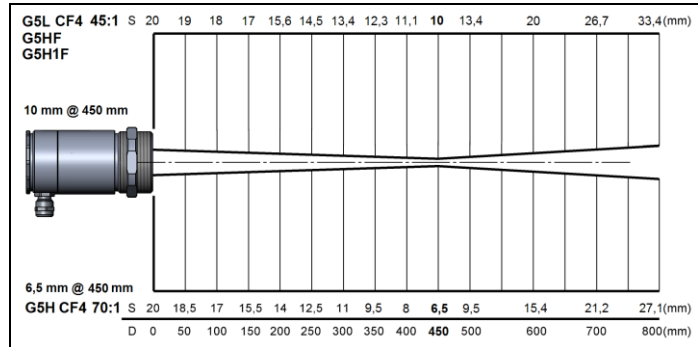



## 4 Accessories

### 4.1 Mounting Brackets

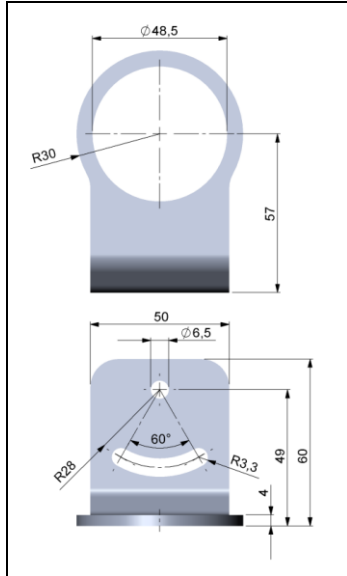

Mounting bracket, adjustable in one axis [ACTLFB]

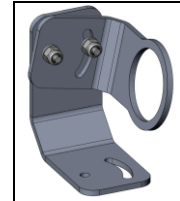
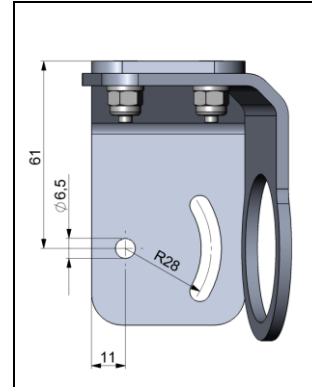
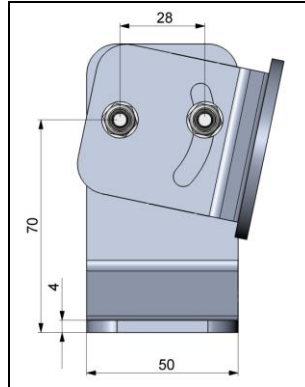

Mounting bracket, adjustable in two axes [ACCTLAB]



For an exact sensor alignment to the object please activate the integrated double laser.

**[▶ 7 Laser Sighting]**

## 4.2 Air Purge Collar

The lens must be kept clean at all times from dust, smoke, fumes and other contaminants in order to avoid reading errors. These effects can be reduced by using an air purge collar. Make sure to use oil-free, technically clean air only.

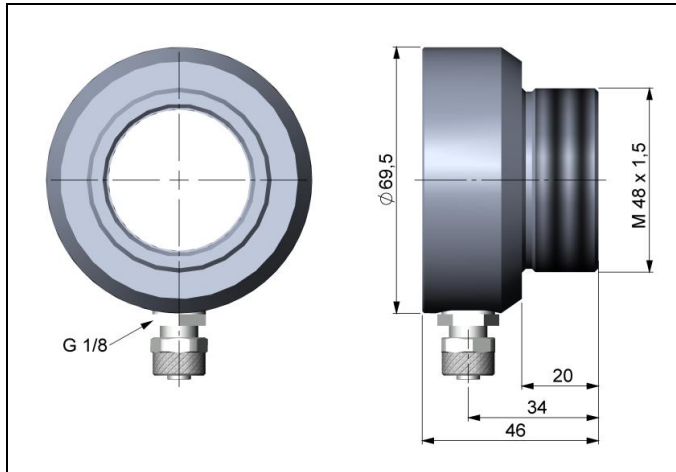

The needed amount of air (approx. 2...10 l/ min.) depends on the application and the installation conditions on-site.



**Air purge collar [ACCTLAP]**

**Hose connection: 6x8 mm**

**Thread (fitting): G 1/8 inch**

### 4.3 Water Cooled Housing

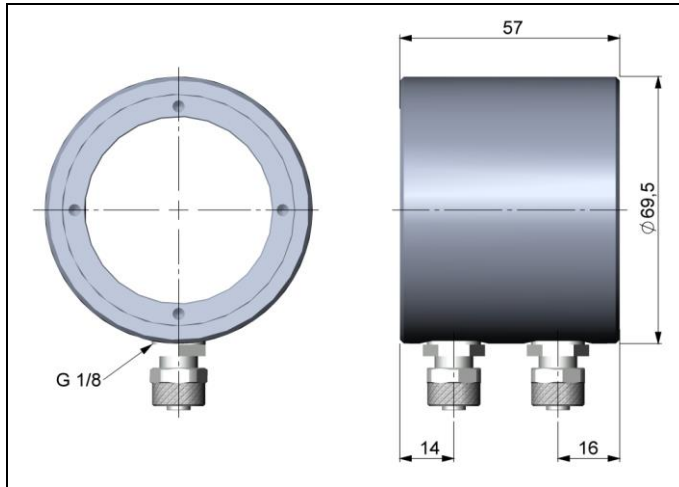

To avoid condensation on the optics an air purge collar is recommended.

Water flow rate: approx. 2 l/ min  
(Cooling water temperature should not exceed 30 °C)

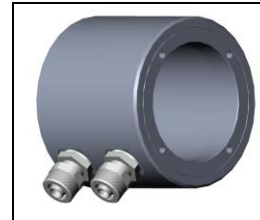

**Water cooled housing [ACCTLW]**

**Hose connection: 6x8 mm**

**Thread (fitting): G 1/8 inch**

The CSLaser can be used at ambient temperatures up to 85 °C without cooling. For applications, where the ambient temperature can reach higher values, the usage of the optional water cooled housing is recommended (operating temperature up to 175 °C). The sensor should be equipped with the optional high temperature cable (operating temperature up to 180 °C).

## 4.4 CoolingJacket Advanced

For very high ambient temperatures (up to 315 °C) the **CoolingJacket Advanced** (cooling housing) is provided.

**Order No.: ACCXLCJA**

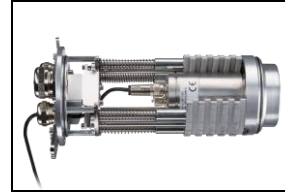

For detailed information see installation manual.

## 4.5 Outdoor protective housing

The CSLaser LT models and the USB server can also be used for outdoor applications by using the outdoor protective housing (**Order No.: ACCTLOPH24ZNS**).

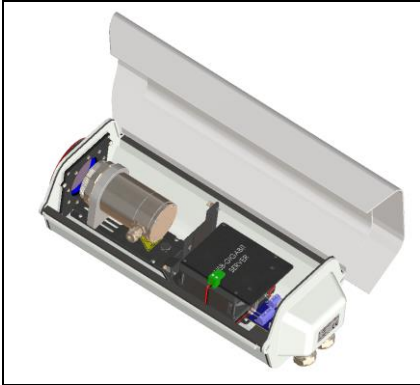

**Outdoor protective housing for CSLaser LT with integrated heater, incl. prot. window (ZnS) and air purge collar/ 24 V DC**



**Outdoor protective housing with wall mount**



For detailed information see installation manual.

## 5 Electrical Installation

### 5.1 Cable Connections

#### Basic version

The basic version is supplied without connection cable. To connect the CSlaser please open at first the sensor backplane (4 screws). Please use a 4-wire shielded cable which you have to conduct through the cable gland. During assembling please make sure the shield gets a safe electrical contact to the sensor housing. For an easier connection the terminal block can be removed from the PCB by pulling off.

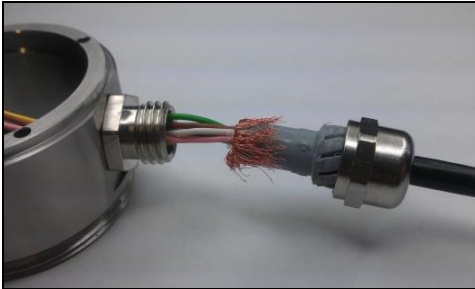
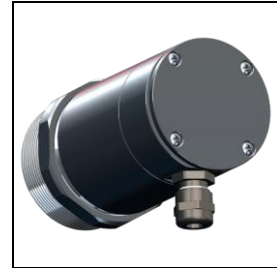

**Shield connection to cable gland**



### Connector version

This version has a connector plug integrated in the sensor backplane. Therefore an opening of the sensor for cable assembling is not necessary. Please use the original ready-made, fitting connection cables which are optionally available. If you want to use own cables please note the pin assignment of the connector (see next page).

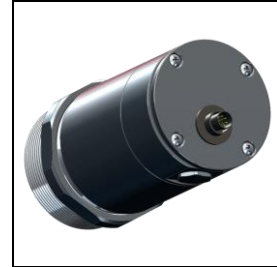

### Power supply

Please use a power supply unit with an output voltage of **5–30 VDC** which can supply **100 mA**.

### Designation (sensor terminal block)

RXD	Receive data (digital)
TXD	Transmit data (digital)
LOOP +	Current loop (+)
LOOP -	Current loop (-)
LASER -	Power supply laser (-)
LASER +	Power supply laser (+)

Above the terminal block you will find two rotary switches for **[▶ 6 Emissivity Setting]**.



Sensor back side with terminal block

### Pin assignment of connector plug (connector version only)

<u>PIN</u>	<u>designation</u>	<u>wire color (original sensor cable)</u>
1	TXD	yellow
2	LOOP -	brown
3	LOOP +	white
4	RXD	green
5	LASER -	grey
6	LASER +	pink
7		

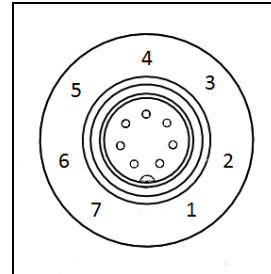

Connector plug (Outer view)

## 5.2 Analog Mode

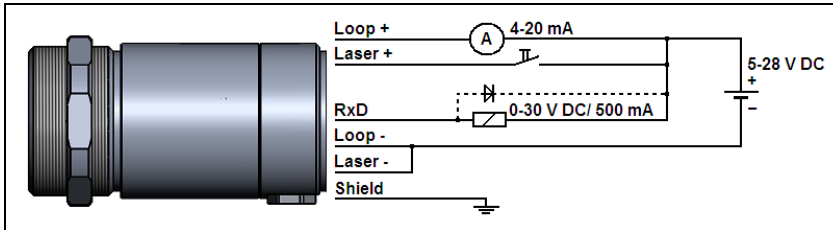

If the CSLaser is used as analog device the sensor provides beside the 4-20 mA signal in addition an alarm output (open-collector) on the RxD pin. To activate the alarm output and set the alarm threshold value the software (optional) is needed. **The supply line for the sighting laser must be led via a switch or pushbutton, which has to be installed max. 2 m away from installation site of the sensor.**

## 5.3 Digital Mode

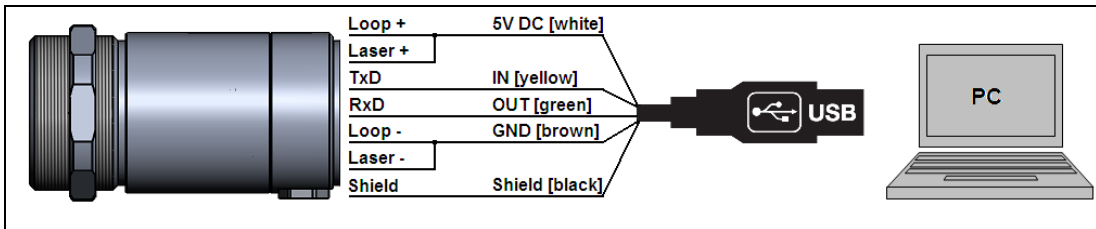

In the digital mode the sensor and the laser will be powered via the 5 V from USB interface. The activation/deactivation of the laser has to be made via the software.

For a digital communication the optional USB programming kit is required. Please connect each wire of the USB adapter cable with the same coloured wire of the sensor cable by using the terminal block. Press with a screw driver as shown in the picture to loose a contact.

Alternatively the USB cable can also be connected directly on the sensor [**► 5.1 Cable Connections**].

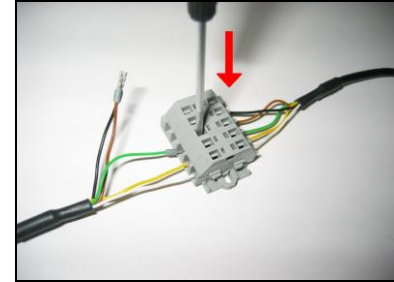

The sensor is offering two ways of digital communication:

- bidirectional communication (sending and receiving data)
- unidirectional communication (burst mode – the sensor is sending data only)

## 5.4 Digital and Analog Mode combined

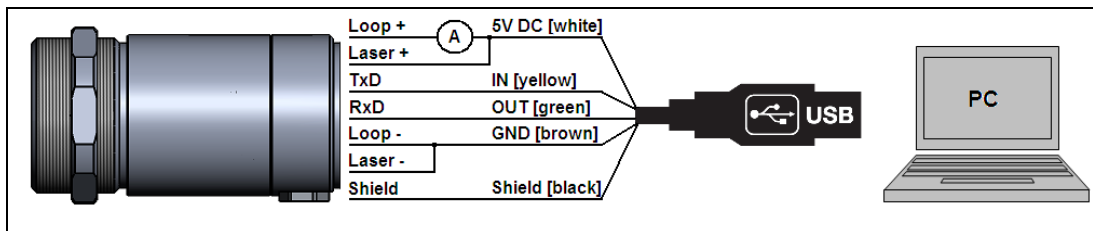

The CSLaser are able to work in the digital mode and simultaneously as analog device (4-20 mA). In this case the sensor will be powered by the USB interface (5 V).

## 5.5 Maximum Loop Impedance

The maximum impedance of the current loop depends on the supply voltage level:

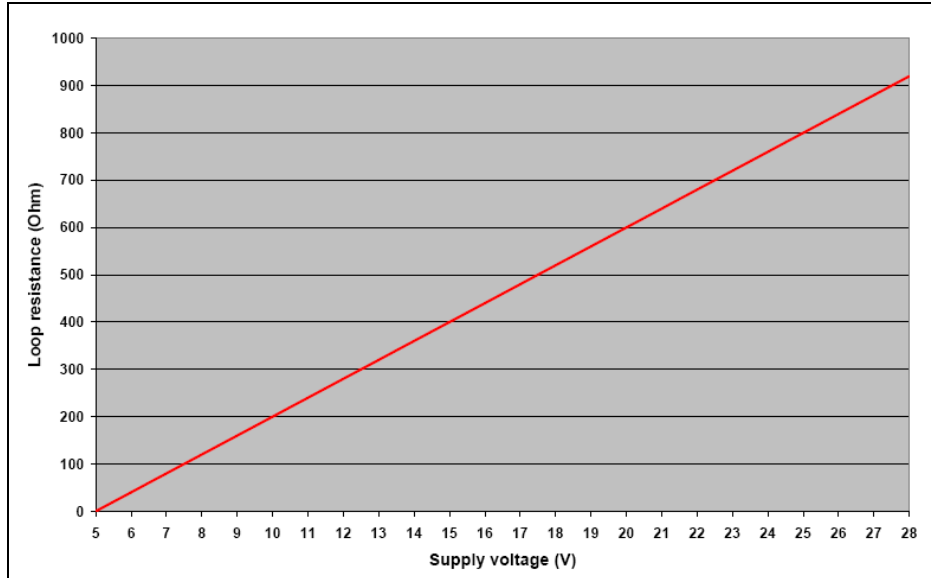

## 6 Emissivity Setting

After opening of the sensor backplane [**► 5.1 Cable Connections**] both of the emissivity switches are accessible.

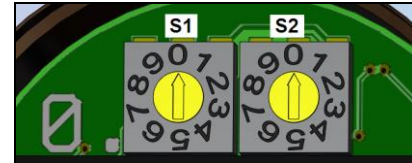

For an emissivity setting of **1,00** please turn both switches to **0**. Values below **0,10** are not adjustable. For all other switch positions the following applies: **0, S1 S2**. Therefore the adjustment range is **0,10...1,09**.

**Example:**  $\epsilon = 0,84$       **S1=8**  
    **S2=4**

If you use the software (optional) please consider that the emissivity switches can be activated/ deactivated in the software menu **Device/ Device setup**. At time of delivery the switches are active.

The emissivity set in the software interacts as a factor to the emissivity set on the unit. Thus the adjustment range increases to **0,100...1,199**.

**Example:**  $\epsilon_{\text{Software}} = 0,952 \times \epsilon_{\text{Sensor}} = 0,82$  (S1=8/ S2=2)

Therefore the effective emissivity is: 0,781.

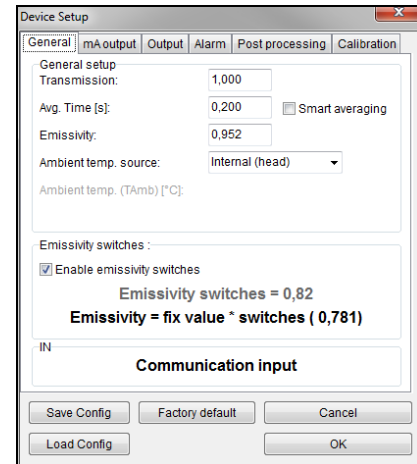

## 7 Laser Sighting

The CSLaser has an integrated double laser aiming which helps for the alignment of the sensor. The measuring spot is located within the two laser points. At the focus point of the according optics [►2.4 Optical Charts] both lasers are crossing and showing as one dot the minimum spot. This enables an alignment of the sensor to the object.



Do not point the laser directly at the eyes of persons or animals! Do not stare into the laser beam. Avoid indirect exposure via reflective surfaces!



The two laser points don't mark the exact measurement spot. They just are for orientation only. The exact size of the measurement spot can be found in the optical charts [►2.4 Optical Charts].



- At ambient temperatures  $>50$  °C the laser will be switched off automatically.
- The laser should only be used for sighting and positioning of the sensor. A permanent use of the laser can reduce the lifetime of the laser diodes.
- Furthermore, in a permanent use of the laser, the measurement accuracy can be affected.

**The supply line for the sighting laser must be led via a switch or pushbutton, which has to be installed max. 2 m away from installation site of the sensor.**

The laser can be activated/ deactivated via this, **by the user on site to be installed switch**, or via the software.



## 8 IRmobile app

The CSLaser sensor has a direct connection to an Android smartphone or tablet. All you have to do is download the IRmobile app for free in the Google Play store. This can also be done via the QR code. An USB-OTG adapter is required for connection to the device.



With IRmobile you are able to monitor and analyse your infrared temperature measurement on a connected smartphone or tablet. This app works on most Android devices running 5.0 or higher with a micro USB or USB-C port supporting USB-OTG (On The Go). It is easy to operate: after you plug your CSLaser device to your phone or tablet, the app will start automatically. The device is powered by your phone. Different digital temperature values can be displayed in the temperature time diagram. You can easily zoom-in the diagram to see more details and small signal changes.

### IRmobile app features:

- Temperature time diagram with zoom function
- Digital temperature values
- Setup of emissivity, transmissivity and other parameters
- Scaling of the analog output and setup of alarm output
- Change of temperature unit: Celsius or Fahrenheit
- Saving/loading of configurations and T/t diagrams
- Restore factory default sensor settings
- Integrated simulator

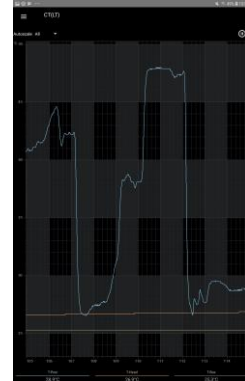

### Supported for:

- Optris pyrometers: Compact series, high performance series and video thermometers
- Optris IR cameras: PI and Xi series
- For android devices running 5.0 or higher with a micro USB port supporting USB-OTG (On The Go)

## 9 Software CompactConnect

### 9.1 Installation

The software can be downloaded under <https://www.optris.global/downloads-software>. Unzip and open the program and start the **CDsetup.exe**. Follow the instructions of the wizard until the installation is finished.

**Minimum system requirements:**

- Windows 7, 8, 10
- USB interface
- Hard disc with at least 30 MByte free space
- At least 128 MByte RAM

The installation wizard will place a launch icon on the desktop and in the start menu:

**[Start]\Programs\CompactConnect**

If you want to uninstall the software from your system, please use the uninstall icon in the start menu.



A detailed description is provided on the downloaded software package.

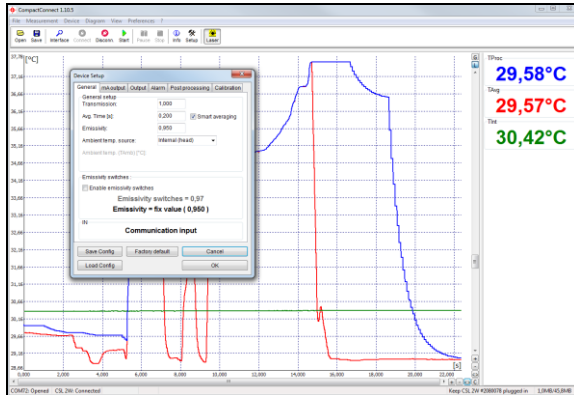

## Main Features:

- Graphic display for temperature trends and automatic data logging for analysis and documentation
- Complete sensor setup and remote controlling
- Adjustment of signal processing functions
- Programming of outputs and functional inputs

## 9.2 Communication Settings

### Serial Interface

Baud rate: 9600 baud  
Data bits: 8  
Parity: none  
Stop bits: 1  
Flow control: off

### Protocol

All sensors of the CSLaser series are using a binary protocol. To get a fast communication the protocol has no additional overhead with CR, LR or ACK bytes.

To power the sensor the control signal "DTR" has to be reset.

## 9.3 Digital Command Set

CSlaser/ CSvideo Commands							
Decimal	HEX	Binary/ ASCII	Command	Data	Answer	Result	Unit
1	0x01	binary	READ Temp - Target	no	byte1 byte2	$= (\text{byte1} \times 256 + \text{byte2} - 1000) / 10$	°C
2	0x02	binary	READ Temp - Head	no	byte1 byte2	$= (\text{byte1} \times 256 + \text{byte2} - 1000) / 10$	°C
3	0x03	binary	READ current Temp - Target	no	byte1 byte2	$= (\text{byte1} \times 256 + \text{byte2} - 1000) / 10$	°C
4	0x04	binary	READ Emissivity	no	byte1 byte2	$= (\text{byte1} \times 256 + \text{byte2}) / 1000$	
5	0x05	binary	READ Transmission	no	byte1 byte2	$= (\text{byte1} \times 256 + \text{byte2}) / 1000$	
9	0x09	binary	READ Processor Temperature	no	byte1	$= (\text{byte1} \times 256 + \text{byte2} - 1000) / 10$	
14	0x0E	binary	READ Serial number	no	byte1 byte2 byte3	$= \text{byte1} \times 65536 + \text{byte2} \times 256 + \text{byte3}$	
15	0x0F	binary	READ FW Rev.	no	byte1 byte2	$= \text{byte1} \times 256 + \text{byte2}$	
16	0x10	binary	READ Laser status	no	byte1	0 = off/ 1 = on	
17	0x11	binary	READ Emissivity switch setting	no		HEX value (e.g. 0x58) = Switch setting (e.g. SW1=5/ SW2=8 -> Eps. = 0,58)	
129	0x81	binary	SET DAC mA	byte1	byte1	$\text{byte1} = \text{mA} \times 10$ (z.B. 4mA = 4 x 10=40)	°C
130	0x82	binary	RESET of DAC mA output				
132	0x84	binary	SET Emissivity	byte1 byte2	byte1 byte2	$= (\text{byte1} \times 256 + \text{byte2}) / 1000$	
133	0x85	binary	SET Transmission	byte1 byte2	byte1 byte2	$= (\text{byte1} \times 256 + \text{byte2}) / 1000$	
144	0x90	binary	SET Laser	byte1	byte1	0 = off/ 1 = on	

**Temperature calculation at CSlaser hs:  $(\text{byte1} \times 256 + \text{byte2} - 1000) / 100$**

**EXAMPLES (all bytes in HEX)**

**Readout of object temperature**

Send: 01 Command for readout of object temperature  
 Receive: 04 D3 Object temperature in tenth degree + 1000  
 04 D3 = dec. 1235  
 1235 - 1000 = 235  
 235 / 10 = **23,5 °C**

**Readout of object temperature (at hs version)**

Send: 01 Command for readout of object temperature  
 Receive: 30 3E Object temperature in hundredth degree + 10000  
 30 3E = dec. 12350  
 12350 - 10000 = 2350  
 2350 / 100 = 23.50 °C

**Set of emissivity**

Send: 84 03 B6  
 Receive: 03 B6  
 03B6 = dec. 950  
 950 / 1000 = **0,950**

## 10 Basics of Infrared Thermometry

Depending on the temperature each object emits a certain amount of infrared radiation. A change in the temperature of the object is accompanied by a change in the intensity of the radiation. For the measurement of “thermal radiation” infrared thermometry uses a wave-length ranging between 1  $\mu\text{m}$  and 20  $\mu\text{m}$ .

The intensity of the emitted radiation depends on the material. This material contingent constant is described with the help of the emissivity which is a known value for most materials (► **11 Emissivity**).

Infrared thermometers are optoelectronic sensors. They calculate the surface temperature on the basis of the emitted infrared radiation from an object. The most important feature of infrared thermometers is that they enable the user to measure objects contactless. Consequently, these products help to measure the temperature of inaccessible or moving objects without difficulties. Infrared thermometers basically consist of the following components:

- lens
- spectral filter
- detector
- electronics (amplifier/ linearization/ signal processing)

The specifications of the lens decisively determine the optical path of the infrared thermometer, which is characterized by the ratio Distance to Spot size.

The spectral filter selects the wavelength range, which is relevant for the temperature measurement. The detector in cooperation with the processing electronics transforms the emitted infrared radiation into electrical signals.

# 11 Emissivity

## 11.1 Definition

The intensity of infrared radiation, which is emitted by each body, depends on the temperature as well as on the radiation features of the surface material of the measuring object. The emissivity ( $\epsilon$  – Epsilon) is used as a material constant factor to describe the ability of the body to emit infrared energy. It can range between 0 and 100 %. A “blackbody” is the ideal radiation source with an emissivity of 1,0 whereas a mirror shows an emissivity of 0,1.

If the emissivity chosen is too high, the infrared thermometer may display a temperature value which is much lower than the real temperature – assuming the measuring object is warmer than its surroundings. A low emissivity (reflective surfaces) carries the risk of inaccurate measuring results by interfering infrared radiation emitted by background objects (flames, heating systems, chamottes). To minimize measuring errors in such cases, the handling should be performed very carefully and the unit should be protected against reflecting radiation sources.

## 11.2 Determination of unknown Emissivities

- ▶ First, determine the actual temperature of the measuring object with a thermocouple or contact sensor. Second, measure the temperature with the infrared thermometer and modify the emissivity until the displayed result corresponds to the actual temperature.
- ▶ If you monitor temperatures of up to 380 °C you may place a special plastic sticker (emissivity dots – part number: ACLSED) onto the measuring object, which covers it completely. Now set the emissivity to 0,95



and take the temperature of the sticker. Afterwards, determine the temperature of the adjacent area on the measuring object and adjust the emissivity according to the value of the temperature of the sticker.

- ▶ Cover a part of the surface of the measuring object with a black, flat paint with an emissivity of 0,98. Adjust the emissivity of your infrared thermometer to 0,98 and take the temperature of the colored surface. Afterwards, determine the temperature of a directly adjacent area and modify the emissivity until the measured value corresponds to the temperature of the colored surface.

**CAUTION: On all three methods the object temperature must be different from ambient temperature.**

### 11.3 Characteristic Emissivities

In case none of the methods mentioned above help to determine the emissivity you may use the emissivity tables ▶ **Appendix A – Emissivity Table Metals** and **Appendix B – Emissivity Table Non Metals**. These are average values, only. The actual emissivity of a material depends on the following factors:

- temperature
- measuring angle
- geometry of the surface
- thickness of the material
- constitution of the surface (polished, oxidized, rough, sandblast)
- spectral range of the measurement
- transmissivity (e.g. with thin films)

## Appendix A – Emissivity Table Metals

Material		typical Emissivity			
Spectral response		1,0 $\mu\text{m}$	1,6 $\mu\text{m}$	5,1 $\mu\text{m}$	8-14 $\mu\text{m}$
Aluminium	non oxidized	0,1-0,2	0,02-0,2	0,02-0,2	0,02-0,1
	polished	0,1-0,2	0,02-0,1	0,02-0,1	0,02-0,1
	roughened	0,2-0,8	0,2-0,6	0,1-0,4	0,1-0,3
	oxidized	0,4	0,4	0,2-0,4	0,2-0,4
Brass	polished	0,35	0,01-0,05	0,01-0,05	0,01-0,05
	roughened	0,65	0,4	0,3	0,3
	oxidized	0,6	0,6	0,5	0,5
Copper	polished	0,05	0,03	0,03	0,03
	roughened	0,05-0,2	0,05-0,2	0,05-0,15	0,05-0,1
	oxidized	0,2-0,8	0,2-0,9	0,5-0,8	0,4-0,8
Chrome		0,4	0,4	0,03-0,3	0,02-0,2
Gold		0,3	0,01-0,1	0,01-0,1	0,01-0,1
Haynes	alloy	0,5-0,9	0,6-0,9	0,3-0,8	0,3-0,8
Inconel	electro polished	0,2-0,5	0,25	0,15	0,15
	sandblast	0,3-0,4	0,3-0,6	0,3-0,6	0,3-0,6
	oxidized	0,4-0,9	0,6-0,9	0,6-0,9	0,7-0,95
Iron	non oxidized	0,35	0,1-0,3	0,05-0,25	0,05-0,2
	rusted		0,6-0,9	0,5-0,8	0,5-0,7
	oxidized	0,7-0,9	0,5-0,9	0,6-0,9	0,5-0,9
	forged, blunt	0,9	0,9	0,9	0,9
	molten	0,35	0,4-0,6		
Iron, casted	non oxidized	0,35	0,3	0,25	0,2
	oxidized	0,9	0,7-0,9	0,65-0,95	0,6-0,95

Material		typical Emissivity			
		1,0 $\mu\text{m}$	1,6 $\mu\text{m}$	5,1 $\mu\text{m}$	8-14 $\mu\text{m}$
Lead	polished	0,35	0,05-0,2	0,05-0,2	0,05-0,1
	roughened	0,65	0,6	0,4	0,4
	oxidized		0,3-0,7	0,2-0,7	0,2-0,6
Magnesium		0,3-0,8	0,05-0,3	0,03-0,15	0,02-0,1
Mercury			0,05-0,15	0,05-0,15	0,05-0,15
Molybdenum	non oxidized	0,25-0,35	0,1-0,3	0,1-0,15	0,1
	oxidized	0,5-0,9	0,4-0,9	0,3-0,7	0,2-0,6
Monel (Ni-Cu)		0,3	0,2-0,6	0,1-0,5	0,1-0,14
Nickel	electrolytic	0,2-0,4	0,1-0,3	0,1-0,15	0,05-0,15
	oxidized	0,8-0,9	0,4-0,7	0,3-0,6	0,2-0,5
Platinum	black		0,95	0,9	0,9
Silver		0,04	0,02	0,02	0,02
Steel	polished plate	0,35	0,25	0,1	0,1
	rustless	0,35	0,2-0,9	0,15-0,8	0,1-0,8
	heavy plate			0,5-0,7	0,4-0,6
	cold-rolled	0,8-0,9	0,8-0,9	0,8-0,9	0,7-0,9
	oxidized	0,8-0,9	0,8-0,9	0,7-0,9	0,7-0,9
Tin	non oxidized	0,25	0,1-0,3	0,05	0,05
Titanium	polished	0,5-0,75	0,3-0,5	0,1-0,3	0,05-0,2
	oxidized		0,6-0,8	0,5-0,7	0,5-0,6
Wolfram	polished	0,35-0,4	0,1-0,3	0,05-0,25	0,03-0,1
Zinc	polished	0,5	0,05	0,03	0,02
	oxidized	0,6	0,15	0,1	0,1

## Appendix B – Emissivity Table Non Metals

Material		typical Emissivity			
Spectral response		1,0 $\mu\text{m}$	2,2 $\mu\text{m}$	5,1 $\mu\text{m}$	8-14 $\mu\text{m}$
Asbestos		0,9	0,8	0,9	0,95
Asphalt				0,95	0,95
Basalt				0,7	0,7
Carbon	non oxidized graphite		0,8-0,9 0,8-0,9	0,8-0,9 0,7-0,9	0,8-0,9 0,7-0,8
Carborundum			0,95	0,9	0,9
Ceramic		0,4	0,8-0,95	0,8-0,95	0,95
Concrete		0,65	0,9	0,9	0,95
Glass	plate melt		0,2 0,4-0,9	0,98 0,9	0,85
Grit				0,95	0,95
Gypsum				0,4-0,97	0,8-0,95
Ice					0,98
Limestone				0,4-0,98	0,98
Paint	non alkaline				0,9-0,95
Paper	any color			0,95	0,95
Plastic >50 $\mu\text{m}$	non transparent			0,95	0,95
Rubber				0,9	0,95
Sand				0,9	0,9
Snow					0,9
Soil					0,9-0,98
Textiles				0,95	0,95
Water					0,93
Wood	natural			0,9-0,95	0,9-0,95

## Appendix C – Smart Averaging

The average function is generally used to smoothen the output signal. With the adjustable parameter time this function can be optimal adjusted to the respective application. One disadvantage of the average function is that fast temperature peaks which are caused by dynamic events are subjected to the same averaging time. Therefore those peaks can only be seen with a delay on the signal output.

The function **Smart Averaging** eliminates this disadvantage by passing those fast events without averaging directly through to the signal output.

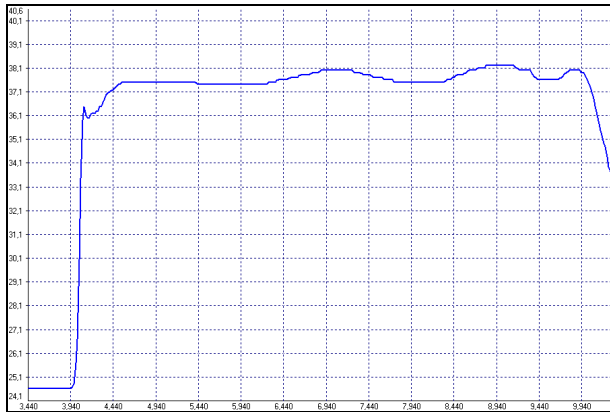

Signal graph with Smart Averaging function

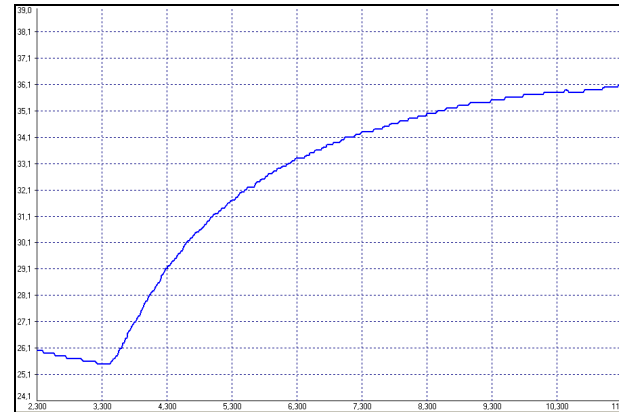

Signal graph without Smart Averaging function

## Appendix D - Declaration of Conformity

### EG-Konformitätserklärung EU Declaration of Conformity



Wir / We

**Optris GmbH**  
Ferdinand Builsson Str. 14  
D-13127 Berlin

erklären in alleiniger Verantwortung, dass  
declare on our own responsibility that

**die Produktserie optris CSlaser**  
**the product group optris CSlaser**

den Anforderungen der EMV-Richtlinie 2014/30/EU und der allgemeinen Produktsicherheitsrichtlinie 2001/95/EG entspricht.  
meets the provisions of the EMC Directive 2014/30/EU and the General Product Safety Directive 2001/95/EC.

Angewandte harmonisierte Normen:  
Applied harmonized standards:

EMV Anforderungen / EMC General Requirements:  
**EN 61326-1:2013** (Grundlegende Prüfanforderungen / Basic requirements)  
**EN 61326-2-3:2013**

Gerätesicherheit von Messgeräten / Safety of measurement devices:

**EN 61010-1:2010**  
**EN 60825-1:2014** (Lasersicherheit / Laser safety)

Dieses Produkt erfüllt die Vorschriften der Richtlinie 2015/863/EU (RoHS) des Europäischen Parlaments und des Rates vom 4. Juni 2015 zur Beschränkung der Verwendung bestimmter gefährlicher Stoffe in Elektro- und Elektronikgeräten.  
This product is in conformity with Directive 2015/863/EU (RoHS) of the European Parliament and of the Council of 4 June 2015 on the restriction of the use of certain hazardous substances in electrical and electronic equipment.

Berlin, 05.08.2021

Ort, Datum / place, date



Dr. Ulrich Kientz  
Geschäftsführer / General Manager



optris CSlaser-MA-E2021-08-A