

Operator's Manual



optris[®] CTlaser

LT/ LTF/ 05M/ 1M/ 2M/ 3M/ 4M/ MT/ F2/ F6/ G5/ G7/ P7

Infrared thermometer

Optris GmbH

Ferdinand-Buisson-Str. 14
13127 Berlin
Germany

Tel.: +49 30 500 197-0

Fax: +49 30 500 197-10

E-mail: info@optris.global

Internet: www.optris.global



Table of contents

Table of contents	3
1 General Notes	9
1.1 Intended use	9
1.2 Warranty	10
1.3 Scope of delivery	10
1.4 Maintenance	11
1.5 Model Overview	12
2 Technical Data	14
2.1 Factory settings	14
2.2 General specifications	17
2.3 Electrical specifications.....	18

2.4	Measurement specifications [LT models]	20
2.5	Measurement specifications [05M model]	21
2.6	Measurement specifications [1M models]	22
2.7	Measurement specifications [2M models]	23
2.8	Measurement specifications [3M models]	24
2.9	Measurement specifications [4M/ MT models]	25
2.10	Measurement specifications [F2/ F6/ P7 models].....	26
2.11	Measurement specifications [G5/ G7 models].....	27
2.12	Optical charts	28
3	Mechanical Installation	46
3.1	Accessories.....	49
3.1.1	Air purge collar.....	49
3.1.2	Mounting bracket	50

3.1.3	Water cooled housing	51
3.1.4	Rail mount adapter for electronic box	52
3.1.5	CoolingJacket Advanced	53
3.1.6	Outdoor protective housing	53
3.1.7	IR app Connector	55
4	Electrical Installation	56
4.1	Connection of the cables	56
4.1.1	Basic version.....	56
4.1.2	Connector version.....	57
4.1.3	Pin assignment of connector plug (connector version only)	58
4.1.4	Designation [models LT/ LTF/ MT/ F2/ F6/ G5/ G7/ P7].....	59
4.1.5	Designation [models 05M/ 1M/ 2M/ 3M]	60
4.1.6	Designation [models 4M]	61

4.2	Power supply	62
4.3	Cable assembling	62
4.4	Ground connection	64
4.4.1	05M, 1M, 2M, 3M models	64
4.4.2	4M model	65
4.4.3	LT, LTF, MT, F2, F6, G5, G7, P7 models	66
4.5	Exchange of the sensing head	67
4.6	Exchange of the head cable	68
4.7	Outputs and Inputs	69
4.7.1	Analog outputs	69
4.7.2	Digital Interfaces	71
4.7.3	Relay outputs	72
4.7.4	Functional inputs (not for CTlaser 4M)	73

4.7.5	I/O Pins (only for CTlaser 4M)	74
4.7.6	Alarms	76
4.7.7	Open collector output / AL2	78
5	Operation	79
5.1	Sensor setup	79
5.2	Aiming laser	91
5.3	Error messages	93
6	IRmobile app	94
7	Software CompactConnect/ CompactPlus Connect	96
7.1	Installation	96
7.2	Communication settings	98
7.2.1	Serial Interface	98
7.2.2	Protocol	98

7.2.3	ASCII-Protocol	99
7.2.4	Save parameter settings	100
8	Basics of Infrared Thermometry	101
9	Emissivity	102
9.1	Definition	102
9.2	Determination of unknown emissivity	103
9.3	Characteristic emissivity	104
	Appendix A – Table of emissivity for metals	105
	Appendix B – Table of emissivity for non-metals	107
	Appendix C – Smart Averaging	108
	Appendix D – Declaration of Conformity	109

1 General Notes

1.1 Intended use

Thank you for choosing the **optris® CTlaser** infrared thermometer.

The sensors of the optris CTlaser series are noncontact infrared temperature sensors. They calculate the surface temperature based on the emitted infrared energy of objects [**►8 Basics of Infrared Thermometry**]. An integrated double laser aiming helps to mark the measurement spot on the object surface. This lies within the two laser points.



The CTlaser sensing head is a sensitive optical system. Please use only the thread for mechanical installation.



- Avoid abrupt changes of the ambient temperature.
- Avoid mechanical violence on the head – this may destroy the system (expiry of warranty).
- If you have any problems or questions, please contact our service department.



Read the manual carefully before the initial start-up. The producer reserves the right to change the herein described specifications in case of technical advance of the product.



► All accessories can be ordered according to the referred part numbers in brackets [].

1.2 Warranty

Each single product passes through a quality process. Nevertheless, if failures occur contact the customer service at once. The warranty period covers 24 months starting on the delivery date. After the warranty is expired the manufacturer guarantees additional 6 months warranty for all repaired or substituted product components. Warranty does not apply to damages, which result from misuse or neglect. The warranty also expires if you open the product. The manufacturer is not liable for consequential damage or in case of a non-intended use of the product.

If a failure occurs during the warranty period the product will be replaced, calibrated or repaired without further charges. The freight costs will be paid by the sender. The manufacturer reserves the right to exchange components of the product instead of repairing it. If the failure results from misuse or neglect the user has to pay for the repair. In that case you may ask for a cost estimate beforehand.

1.3 Scope of delivery

- CTlaser sensing head with connection cable and electronic box
- Mounting nut and mounting bracket (fixed)
- Operators manual

1.4 Maintenance

Blow off loose particles using clean compressed air. The lens surface can be cleaned with a soft, humid tissue (moistened with water) or a lens cleaner (e.g. Purosol or B+W Lens Cleaner).



Never use cleaning compounds which contain solvents (neither for the lens nor for the housing).

1.5 Model Overview

The sensors of the CTlaser series are available in the following basic versions:

Model	Model code	Measurement range	Spectral response	Typical applications
CTlaser LT	LT	-50 to 975 °C	8-14 μm	non-metallic surfaces
CTlaser F	LTF	-50 to 975 °C	8-14 μm	fast processes
CTlaser 05M	05M	1000 to 2000 °C	0.525 μm	measurement of liquid metal
CTlaser 1M	1ML 1MH 1MH1	485 to 1050 °C 650 to 1800 °C 800 to 2200 °C	1,0 μm	metals and ceramic surfaces
CTlaser 2M	2ML 2MH 2MH1	250 to 800 °C 385 to 1600 °C 490 to 2000 °C	1.6 μm	metals and ceramic surfaces
CTlaser 3M	3ML 3MH 3MH1 3MH2 3MH3	50 to 400 °C 100 to 600 °C 150 to 1000 °C 200 to 1500 °C 250 to 1800 °C	2.3 μm	metals at low object temperatures (from 50 °C)
CTlaser 4M	4ML	0 to 500 °C	2.2-6 μm	metals at low object temperatures (from 0 °C) and very fast processes
CTlaser MT	MT	200 to 1450 °C	3.9 μm	measurement through flames

	MTH	400 to 1650 °C		
CTlaser F2	F2 F2H	200 to 1450 °C 400 to 1650 °C	4.24 μm	measurement of CO ₂ -flame gases
CTlaser F6	F6 F6H	200 to 1450 °C 400 to 1650 °C	4.64 μm	measurement of CO-flame gases
CTlaser G5	G5L G5H G5HF G5H1F	100 to 1200 °C 250 to 1650 °C 200 to 1450 °C 400 to 1650 °C	5,0 μm	measurement of glass
CTlaser G7	G7	100 to 1200 °C	7,9 μm	measurement of glass
CTlaser P7	P7	0 to 710 °C	7.9 μm	plastic foils and surfaces of glass

Table 1: Overview of models

In the following chapters of this manual you will find only the short model codes. On the 1M, 2M, 3M, 4M and G5 models the whole measurement range is split into several sub ranges (L, H, H1 etc.).

2 Technical Data

2.1 Factory settings



Smart Averaging means a dynamic average adaptation at high signal edges. [Activation via software only]. [**► Appendix C – Smart Averaging**]

Signal output object temperature	0 – 5 V
Emissivity	0.970 [LT/ LTF/ MT/ F2/ F6/ G5/ G7/ P7] 1.000 [05M/ 1M/ 2M/ 3M/ 4M]
Transmissivity	1.000
Average time (AVG)	0.2 s [LT]; 0.1 s [LTF/ MT/ F2/ F6/ G5/ G7/ P7] 0.001 s [05M/ 1M/ 2M/ 3M/ 4M]
Smart Averaging	Inactive (active [LTF])
Peak hold	Inactive
Valley hold	Inactive

	<u>LT/ LTF</u>	<u>05M</u>	<u>1ML</u>	<u>1MH</u>	<u>1MH1</u>	<u>2ML</u>	<u>2MH</u>	<u>2MH1</u>	<u>3ML</u>	<u>3MH</u>	<u>3MH1</u>	<u>3MH2</u>	<u>3MH3</u>
Lower limit temperature range [°C]	0	1000	485	650	800	250	385	490	50	100	150	200	250
Upper limit temperature range [°C]	500	2000	1050	1800	2200	800	1600	2000	400	600	1000	1500	1800
Lower alarm limit [°C] (Normally closed)	30	1200	600	800	1200	350	500	800	100	250	350	550	750
Upper alarm limit [°C] (Normally open)	100	1600	900	1400	1600	600	1200	1400	300	500	600	1000	1200
Lower limit signal output	0 V												
Upper limit signal output	5 V												
Temperature unit	°C												
Ambient temperature compensation (on LT, LTF, MT, F2, F6, G5, G7, P7 output at OUT-AMB as 0-5 V signal)	internal head temperature probe												
Baud rate [kBaud]	115												
Laser	inactive												

	<u>4ML</u>	<u>MT</u>	<u>MTH</u>	<u>F2</u>	<u>F2H</u>	<u>F6</u>	<u>F6H</u>	<u>G5L</u>	<u>G5H</u>	<u>G5HF</u>	<u>G7</u>	<u>P7</u>
Lower limit temperature range [°C]	0	200	400	200	400	200	400	100	250	200	100	0
Upper limit temperature range [°C]	500	1450	1650	1450	1650	1450	1650	1200	400	600	1200	710
Lower alarm limit [°C] (Normally closed)	30	400	600	400	600	400	600	200	350	350	200	30
Upper alarm limit [°C] (Normally open)	100	1200	1400	1200	1400	1200	1400	500	900	900	500	100
Lower limit signal output	0 V											
Upper limit signal output	5 V											
Temperature unit	°C											
Ambient temperature compensation (on LT, LTF, MT, F2, F6, G5, G7, P7 output at OUT-AMB as 0-5 V signal)	internal head temperature probe											
Baud rate [kBaud]	115 (4M: 921,6)											
Laser	inactive											

2.2 General specifications

	Sensing head	Electronic box
Environmental rating	IP65 (NEMA-4)	
Ambient temperature ¹⁾	-20...85 °C (4ML: -20...70 °C)	
Storage temperature	-40...85 °C (3M: -40...125 °C)	-40...85 °C
Relative humidity	10...95 %, noncondensing	
Material	Stainless steel	Die casting zinc
Dimensions	100 mm x 50 mm, M48x1.5	89 mm x 70 mm x 30 mm
Weight	600 g	420 g
Cable length	3 m (standard), 8 m, 15 m	
Cable diameter	5 mm	
Ambient temperature cable	Max. 105 °C [High temperature cable (optional): 180 °C]	
Vibration	IEC 60068-2-6 (sinus shaped), IEC 60068-2-64 (broad band noise)	

Shock	IEC 60068-2-27 (25G and 50G)	
Software (optional)	CompactConnect	

¹⁾ Laser will turn off automatically at ambient temperatures >50 °C. The functionality of the LCD display can be limited at ambient temperatures below 0 °C.

2.3 Electrical specifications

Power supply	8–36 VDC (4M: 8-30 VDC / 5 V USB / max. 1,2 W)
Current draw	Max. 160 mA
Aiming laser	635 nm, 1 mW, On/ Off via programming keys or software
Outputs/ analog	(For 4M output 1 and 2 are freely selectable: Analog mA/mV, Alarm mA/mV, TCK)
Channel 1	selectable: 0/ 4–20 mA, 0–5/ 10 V, thermocouple (J or K) or alarm output (Signal source: object temperature)
Channel 2 (LT/ LTF/ MT/ F2/ F6/ G5/ G7/ P7 only)	Head temperature [-20...180 °C] as 0–5 V or 0–10 V output or alarm output (Signal source switchable to object temperature or electronic box temperature if used as alarm output)
Alarm output	Open collector (NPN type) output at Pin AL2 [24 V/ 50 mA]
Output impedances	
mA	Max. loop resistance 500 Ω (at 8-36 VDC)

mV	Min. 100 k Ω load impedance
Thermocouple	20 Ω
Digital interfaces	USB, RS232, RS485, Profibus DP, Modbus RTU, Ethernet (optional plug-in modules)
Relay outputs	2 x 60 VDC/ 42 VAC _{RMS} , 0.4 A; optically isolated (optional plug-in module)
Functional inputs	F1-F3; software programmable for the following functions: <ul style="list-style-type: none">- external emissivity adjustment- ambient temperature compensation- trigger (reset of hold functions) 4M: I/O1-3 pins freely selectable via software

2.4 Measurement specifications [LT models]

	<u>LT</u>	<u>LTF</u>
Temperature range (scalable)	-50...975 °C	
Spectral range	8...14 μm	
Optical resolution	75:1	50:1
System accuracy ^{1) 2) 3)}	±1 °C or ±1 %	±1,5 °C or ±1,5 %
Repeatability ^{1) 3)}	±0.5 °C or ±0.5 %	±1 °C or ±1 %
Temperature coefficient ⁴⁾	±0,05 K/ K or ±0,05 %/ K	
NETD ^{3) 5)}	0.1 K	0.5 K
Response time (90 % signal)	120 ms	9 ms
Warm-up time	10 min	
Emissivity/ Gain, Transmissivity	0.100...1.100 (adjustable via programming keys or software)	
Signal processing	Average, peak hold, valley hold (adjustable via programming keys or software)	

¹⁾ at ambient temp. 23 ±5 °C; at object temperatures >0 °C (LT) / ≥ 20 °C (LTF); response time=1 s

²⁾ Accuracy for thermocouple output: ±2.5 °C or ±1 %, whichever is greater

³⁾ ε =1

⁴⁾ for ambient temperatures (head) <18 °C and >28 °C; whichever is greater

⁵⁾ at time constant of 200 ms (LT) / 100 ms (LTF) and an object temperature of 25 °C

2.5 Measurement specifications [05M model]

	05M
Temperature range (scalable)	1000...2000 °C
Spectral range	0.525 µm
Optical resolution	150:1
System accuracy ^{1) 2) 3)}	± 1 % T _{Meas} (≤ 1100 °C) ± (0.3 % T _{Meas} + 2 °C) (>1100 °C)
Repeatability ^{1) 3)}	± 0.5 % T _{Meas} (≤ 1100 °C) ± (0.1 % T _{Meas} + 1 °C) (>1100 °C)
Temperature coefficient ⁴⁾	±0,05 K/ K or ±0,05 %/ K
NETD ^{3) 5)}	0.2 K
Response time (90 % signal) ⁶⁾	1 ms
Emissivity/ Gain	0.100...1.100 (adjustable via programming keys or software)
Transmissivity	0.100...1.000 (adjustable via programming keys or software)
Signal processing	Average, peak hold, valley hold (adjustable via programming keys or software)

¹⁾ at ambient temp. 23 ±5 °C; whichever is greater; response time=1 s

²⁾ Accuracy for thermocouple output: ±2.5 °C or ±1 %, whichever is greater

³⁾ ε = 1 ⁴⁾ for ambient temperatures (head) <18 °C and >28 °C; whichever is greater ⁵⁾ at time constant 1 ms and object temperature=start of measurement range + 50 °C ⁶⁾ with dynamic adaptation at low signal levels

2.6 Measurement specifications [1M models]

	<u>1ML</u>	<u>1MH</u>	<u>1MH1</u>
Temperature range (scalable)	485...1050 °C	650...1800 °C	800...2200 °C
Spectral range	1,0 µm		
Optical resolution	150:1	300:1	
System accuracy ^{1) 2) 3)}	$\pm(0.3 \% T_{\text{Meas}} + 2 \text{ °C})$		
Repeatability ^{1) 3)}	$\pm(0.1 \% T_{\text{Meas}} + 1 \text{ °C})$		
Temperature coefficient ⁴⁾	$\pm 0,05 \text{ K/ K}$ or $\pm 0,05 \% / \text{ K}$		
NETD ^{3) 5)}	0.1 K		
Response time (90 % signal) ⁶⁾	1 ms		
Emissivity/ Gain	0.100...1.100 (adjustable via programming keys or software)		
Transmissivity	0.100...1.000 (adjustable via programming keys or software)		
Signal processing	Average, peak hold, valley hold (adjustable via programming keys or software)		

¹⁾ at ambient temp. $23 \pm 5 \text{ °C}$; whichever is greater; response time=1 s

²⁾ Accuracy for thermocouple output: $\pm 2.5 \text{ °C}$ or $\pm 1 \%$, whichever is greater

³⁾ $\epsilon = 1$

⁴⁾ for ambient temperatures (head) $< 18 \text{ °C}$ and $> 28 \text{ °C}$; whichever is greater

⁵⁾ at time constant 1 ms and object temperature=start of measurement range + 50 °C

⁶⁾ with dynamic adaptation at low signal levels

2.7 Measurement specifications [2M models]

	<u>2ML</u>	<u>2MH</u>	<u>2MH1</u>
Temperature range (scalable)	250...800 °C	385...1600 °C	490...2000 °C
Spectral range	1.6 µm		
Optical resolution	150:1	300:1	
System accuracy ^{1) 2) 3)}	±(0.3 % T _{Meas} +2 °C)		
Repeatability ^{1) 3)}	±(0.1 % T _{Meas} +1 °C)		
Temperature coefficient ⁴⁾	±0,05 K/ K or ±0,05 %/ K		
NETD ^{3) 5)}	0.1 K		
Response time (90 % signal) ⁶⁾	1 ms		
Emissivity/ Gain	0.100...1.100 (adjustable via programming keys or software)		
Transmissivity	0.100...1.000 (adjustable via programming keys or software)		
Signal processing	Average, peak hold, valley hold (adjustable via programming keys or software)		

¹⁾ at ambient temp. 23 ±5 °C; whichever is greater; response time=1 s

²⁾ Accuracy for thermocouple output: ±2.5 °C or ±1 %, whichever is greater

³⁾ ε =1

⁴⁾ for ambient temperatures (head) <18 °C and >28 °C; whichever is greater

⁵⁾ at time constant 1 ms and object temperature=start of measurement range + 50 °C

⁶⁾ with dynamic adaptation at low signal levels

2.8 Measurement specifications [3M models]

	3ML ¹⁾	3MH ¹⁾	3MH1 ²⁾	3MH2 ²⁾	3MH3 ²⁾
Temperature range (scalable)	50...400 °C	100...600 °C	150...1000 °C	200...1500 °C	250...1800 °C
Spectral range	2,3 µm				
Optical resolution	60:1	100:1	300:1		
System accuracy ^{3) 4) 5)}	±(0,3 % T _{Mess} +2 °C)				
Repeatability ^{3) 5)}	±(0,1 % T _{Mess} +1 °C)				
Temperature coefficient ⁶⁾	±0,05 K/ K or ±0,05 %/ K				
NETD ^{5) 7)}	0,1 K				
Response time (90 % signal) ⁸⁾	1 ms				
Emissivity/ Gain	0,100...1,100 (adjustable via programming keys or software)				
Transmissivity	0,100...1,000 (adjustable via programming keys or software)				
Signal processing	Average, peak hold, valley hold (adjustable via programming keys or software)				

¹⁾ T_{Object} > T_{Head}+25 °C

²⁾ Specification valid at T_{Object} ≥ start of measurement range + 50 °C

³⁾ at ambient temp. 23 ±5 °C; whichever is greater; response time=1 s

⁴⁾ Accuracy for thermocouple output: ±2.5 °C or ±1 %, whichever is greater

⁵⁾ ε = 1 ⁶⁾ for ambient temperatures (head) <18 °C and >28 °C; whichever is greater ⁷⁾ at time constant 1 ms and object temperature=start of measurement range + 50 °C ⁸⁾ with dynamic adaptation at low signal levels

2.9 Measurement specifications [4M/ MT models]

	<u>4ML</u>	<u>MT</u>	<u>MTH</u>
Temperature range (scalable)	0...500 °C	200...1450 °C	400...1650 °C
Spectral range	2,2-6 µm	3,9 µm	
Optical resolution	33:1	45:1	
System accuracy ¹⁾²⁾	±(0,3 % T _{Mess} +2 °C)	±1 % ³⁾	
Repeatability ¹⁾	±(0,1 % T _{Mess} +1 °C)	±0,5 % or 0,5 °C ³⁾	
Temperature coefficient ⁴⁾	±0,05 K/ K or ±0,03 %/ K ⁵⁾	±0,05 K/ K or ±0,05 %/ K	
NETD ⁶⁾	180 mK	0,1 K	
Response time (90 % signal)	300 µs (Exposure time: 90 µs)	10 ms	
Emissivity/ Gain	0,100...1,100 (adjustable via programming keys or software)		
Transmissivity	0,100...1,000 (adjustable via programming keys or software)		
Signal processing	Average, peak hold, valley hold (adjustable via programming keys or software)		

¹⁾ at ambient temp. 23 ±5 °C; whichever is greater; response time=1 s

²⁾ Accuracy for thermocouple output: ±2.5 °C or ±1 %

³⁾ MT: at object temperatures >300 °C with dynamic adaptation at low signal levels

⁴⁾ for ambient temperatures (head) <18 °C and >28 °C; whichever is greater

⁵⁾ for ambient temperatures > 10 °C; whichever is greater

⁶⁾ ε = 1 ⁷⁾ at time constant 1 ms and T_{Obj} = 50 °C

2.10 Measurement specifications [F2/ F6/ P7 models]

	<u>F2</u>	<u>F2H</u>	<u>F6</u>	<u>F6H</u>	<u>P7</u>
Temperature range (scalable)	200...1450 °C	400...1650 °C	200...1450 °C	400...1650 °C	0...710 °C
Spectral range	4,24 μm		4,64 μm		7,9 μm
Optical resolution	45:1				
System accuracy ^{1),2)}	±1 % ³⁾				±1,5 °C or ±1 %
Repeatability ¹⁾	±0,5 °C or ±0,5 % ²⁾				
Temperature coefficient ⁴⁾	±0,05 K/ K or ±0,05 %/ K				
NETD ⁵⁾	0,1 K				0,5 K
Response time (90 % signal)	10 ms				150 ms
Emissivity/ Gain	0.100...1.100 (adjustable via programming keys or software)				
Transmissivity	0.100...1.000 (adjustable via programming keys or software)				
Signal processing	Average, peak hold, valley hold (adjustable via programming keys or software)				

¹⁾ at ambient temp. 23 ±5 °C; whichever is greater; response time=1 s

²⁾ Accuracy for thermocouple output: ±2.5 °C or ±1 %

³⁾ at object temperatures >300 °C (F2/F6)

⁴⁾ for ambient temperatures (head) <18 °C and >28 °C; whichever is greater

⁵⁾ ε = 1; at time constant 200 ms and object temperature=start of measurement range + 50 °C

2.11 Measurement specifications [G5/ G7 models]

	<u>G5L</u>	<u>G5H</u>	<u>G5HF</u>	<u>G5H1F</u>	<u>G7</u>
Temperature range (scalable)	100...1200 °C	250...1650 °C	200...1450 °C	400...1650 °C	100...1200 °C
Optical resolution	5,0 µm				7,9 µm
System accuracy ^{1) 2), 3)}	45:1	70:1	45:1		
Repeatability ^{1) 3)}	±1,5 °C or ±1 %				
Temperature coefficient ⁴⁾	±0,05 K/ K or ±0,05 %/ K				
NETD ^{3) 5)}	±0,5 °C or ±0,5 %				
Response time (90 % signal)	0,1 K				0,5 K
Emissivity/ Gain	120 ms	80 ms	10 ms		150 ms
Transmissivity	0,100...1,100 (adjustable via programming keys or software)				
Signal processing	0,100...1,100 (adjustable via programming keys or software)				
Optical resolution	Mittelwert, MAX, MIN (adjustable via programming keys or software)				

¹⁾ at ambient temp. 23 ±5 °C; whichever is greater; response time=1 s

²⁾ Accuracy for thermocouple output: ±2.5 °C or ±1 %

³⁾ $\epsilon = 1$

⁴⁾ for ambient temperatures (head) <18 °C and >28 °C; whichever is greater

⁵⁾ at time constant 200 ms and object temperature=start of measurement range + 50 °C

2.12 Optical charts

The following optical charts show the diameter of the measuring spot in dependence on the distance between measuring object and sensing head. The spot size refers to **90 % of the radiation energy**. The distance is always measured from the front edge of the sensing head.

As an alternative to the optical diagrams, the [spot size calculator](#) can also be used on the Optris website or via the Optris calculator app. The app can be downloaded for free from the Google Play store (see QR code).



D = Distance from front of the sensing head to the object

S = Spot size

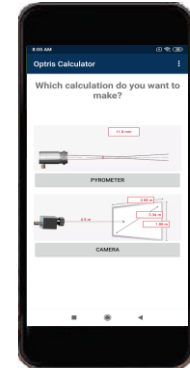

The size of the measuring object and the optical resolution of the infrared thermometer determine the maximum distance between sensing head and measuring object.

In order to prevent measuring errors the object should fill out the field of view of the optics completely.

Consequently, the spot should at all times have at least **the same size** like the object or should be **smaller than** that.



Optics: SF

D:S (focus distance) = 75:1/ 16mm@1200mm

D:S (far field) = 24:1

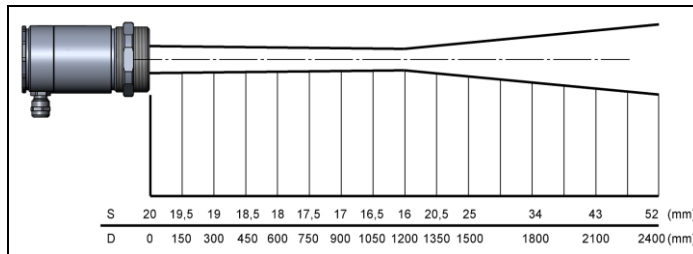

Optics: CF1

D:S (focus distance) = 75:1/ 0.9mm@70mm

D:S (far field) = 3.5:1

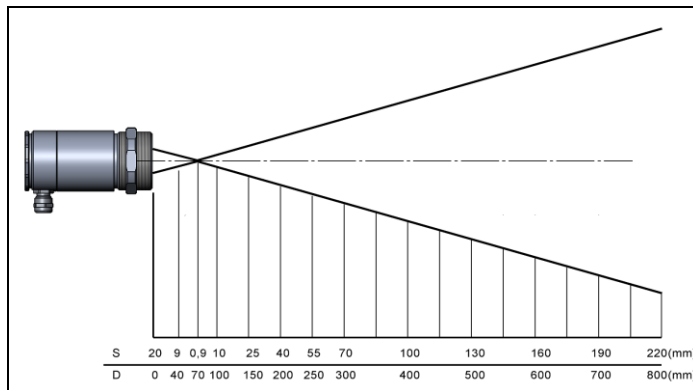

LT

Optics: CF2

D:S (focus distance) = 75:1/ 1.9mm@150mm

D:S (far field) = 7:1

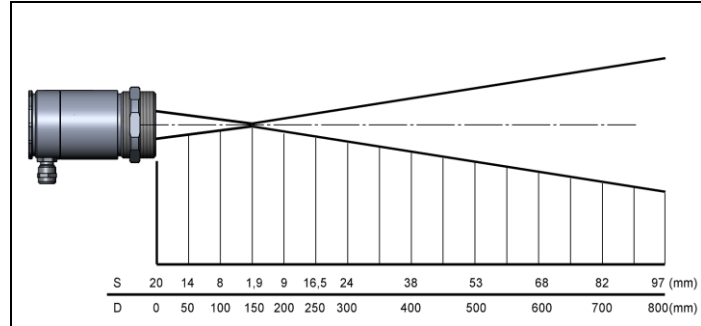

LT

Optics: CF3

D:S (focus distance) = 75:1/ 2.75mm@200mm

D:S (far field) = 9:1

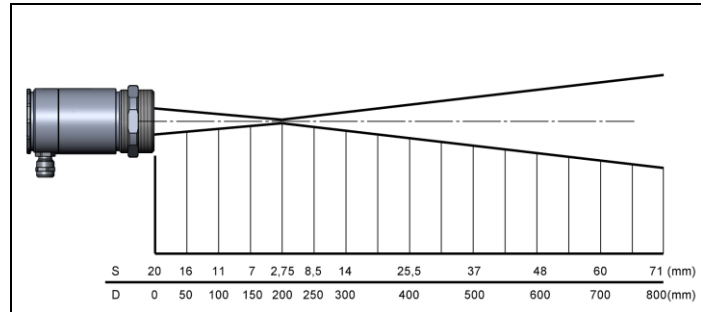

LT

Optics: CF4

D:S (focus distance) = 75:1/ 5.9mm@450mm

D:S (far field) = 18:1

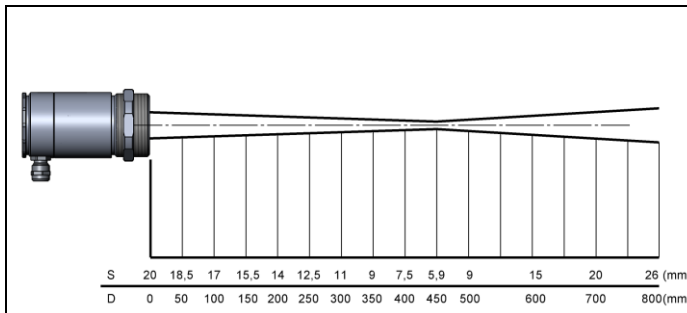

LTF

Optics: SF

D:S (focus distance) = 50:1/ 24mm@1200mm

D:S (far field) = 20:1

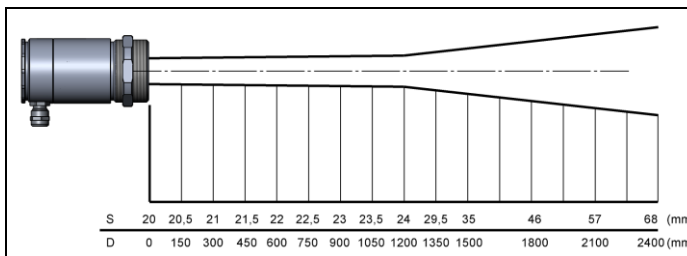

LTF

Optics: CF1

D:S (focus distance) = 50:1/ 1.4mm@70mm

D:S (far field) = 3.5:1

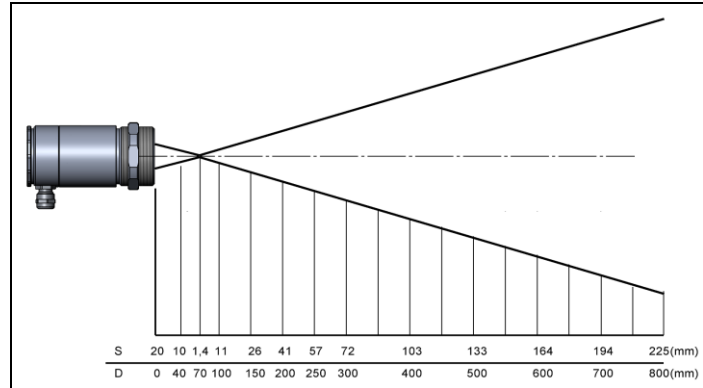
**LTF**

Optics: CF2

D:S (focus distance) = 50:1/ 3mm@150mm

D:S (far field) = 6:1

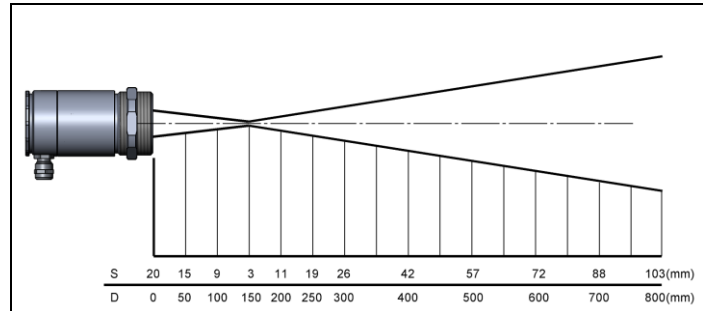

LTF

Optics: CF3

D:S (focus distance) = 50:1/ 4mm@200mm

D:S (far field) = 8:1

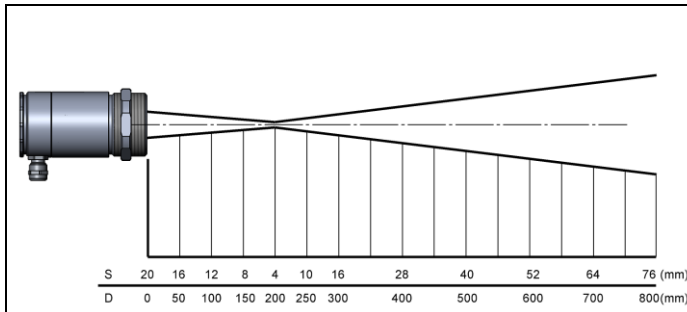

LTF

Optics: CF4

D:S (focus distance) = 50:1/ 9mm@450mm

D:S (far field) = 16:1

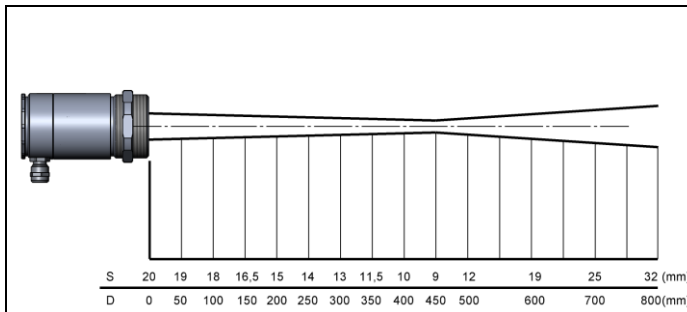

1MH/ 1MH1/ 2MH/ 2MH1/ 3MH1-H3

Optics: FF

D:S (focus distance) = 300:1/ 12mm@ 3600mm
 D:S (far field) = 115:1

05M/ 1ML/ 2ML

Optics: FF

D:S (focus distance) = 150:1/ 24mm@ 3600mm
 D:S (far field) = 84:1

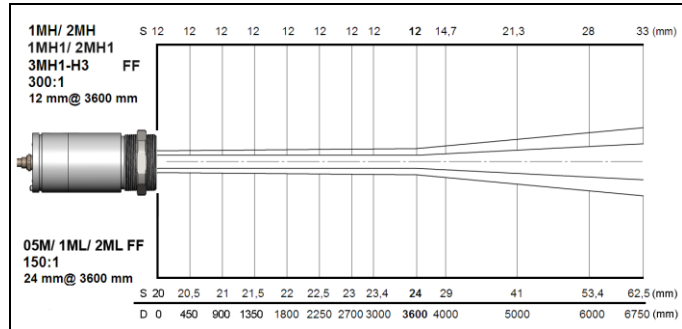

1MH/ 1MH1/ 2MH/ 2MH1/ 3MH1-H3

Optics: SF

D:S (focus distance) = 300:1/ 3,7mm@ 1100mm
 D:S (far field) = 48:1

05M/ 1ML/ 2ML

Optics: SF

D:S (focus distance) = 150:1/ 7,3mm@ 1100mm
 D:S (far field) = 42:1

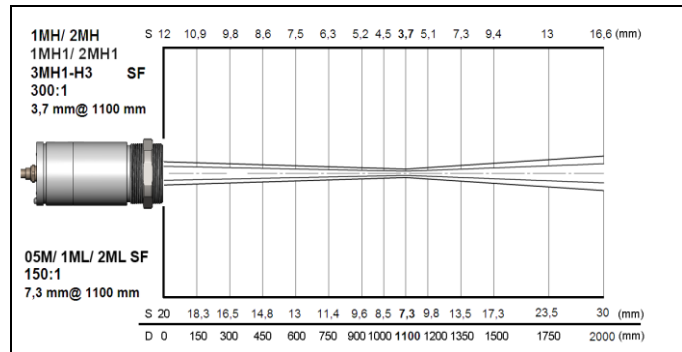

1MH/ 1MH1/ 2MH/ 2MH1/ 3MH1-H3

Optics: CF2

D:S (focus distance) = 300:1/ 0,5mm@ 150mm

D:S (far field) = 7,5:1

1ML/ 2ML

Optics: CF2

D:S (focus distance) = 150:1/ 1mm@ 150mm

D:S (far field) = 7:1

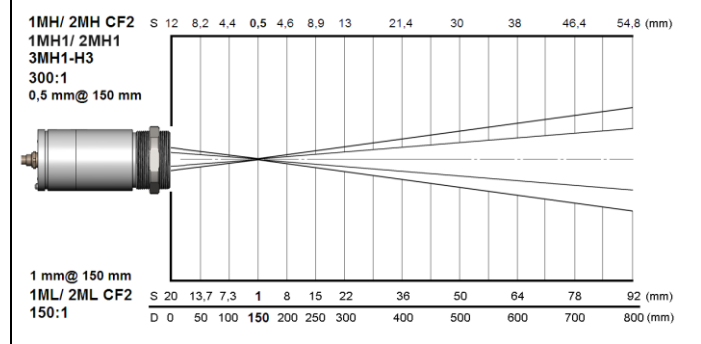

1MH/ 1MH1/ 2MH/ 2MH1/ 3MH1-H3

Optics: CF3

D:S (focus distance) = 300:1/ 0,7mm@ 200mm

D:S (far field) = 10:1

1ML/ 2ML

Optics: CF3

D:S (focus distance) = 150:1/ 1,3mm@ 200mm

D:S (far field) = 10:1

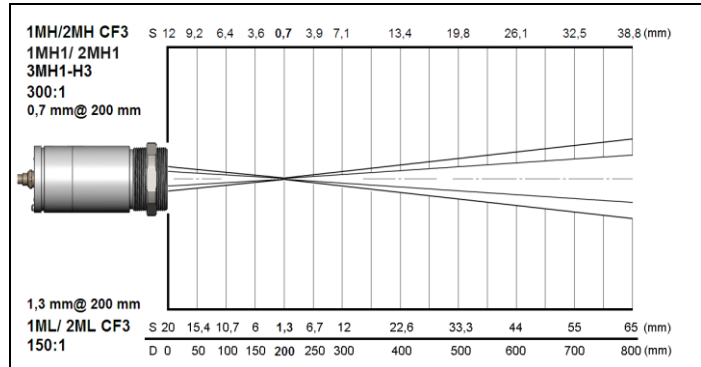

1MH/ 1MH1/ 2MH/ 2MH1/ 3MH1-H3

Optics: CF4

D:S (focus distance) = 300:1/ 1,5mm@ 450mm
 D:S (far field) = 22:1

1ML/ 2ML

Optics: CF4

D:S (focus distance) = 150:1/ 3mm@ 450mm
 D:S (far field) = 20:1

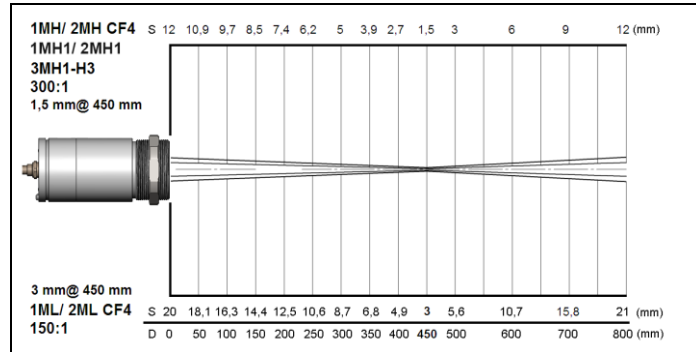

3MH

Optics: FF

D:S (focus distance) = 100:1/ 36mm@ 3600mm
 D:S (far field) = 65:1

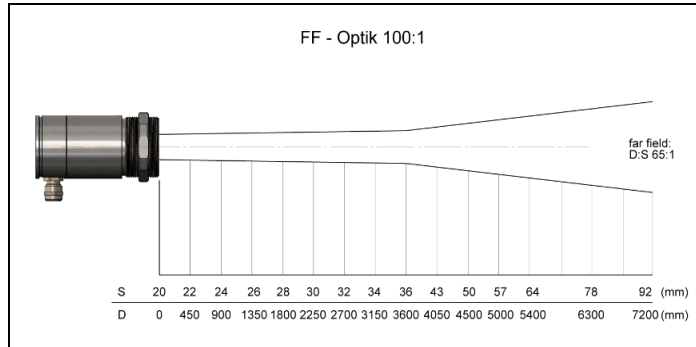

3ML

Optics: FF

D:S (focus distance) = 60:1/ 60mm@ 3600mm

D:S (far field) = 45:1

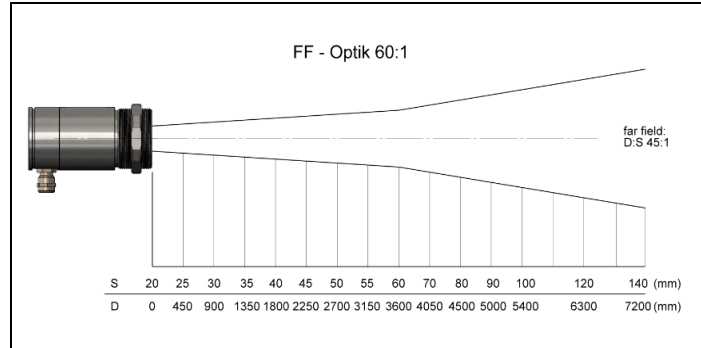

3MH

Optics: SF

D:S (focus distance) = 100:1/ 11mm@ 1100mm

D:S (far field) = 38:1

3ML

Optics: SF

D:S (focus distance) = 60:1/ 18.3mm@ 1100mm

D:S (far field) = 30:1

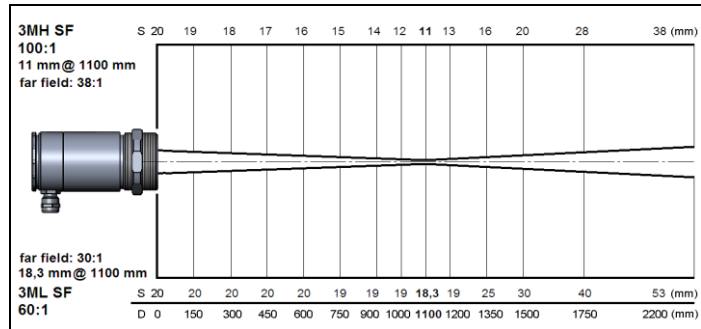

3MH

Optics: CF1

D:S (focus distance) = 100:1/ 0.85mm@ 85mm

D:S (far field) = 4:1

3ML

Optics: CF1

D:S (focus distance) = 60:1/ 1.4mm@ 85mm

D:S (far field) = 4:1

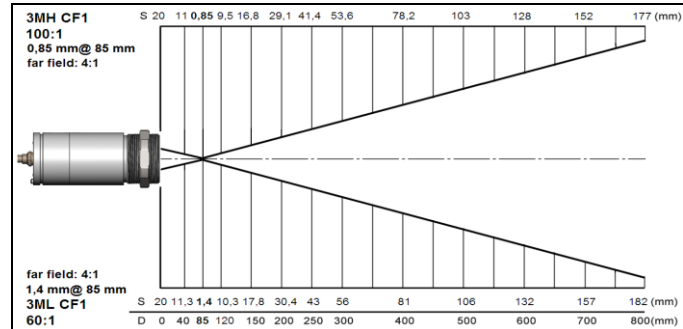
**3MH**

Optics: CF2

D:S (focus distance) = 100:1/ 1.5mm@ 150mm

D:S (far field) = 7:1

3ML

Optics: CF2

D:S (focus distance) = 60:1/ 2.5mm@ 150mm

D:S (far field) = 6:1

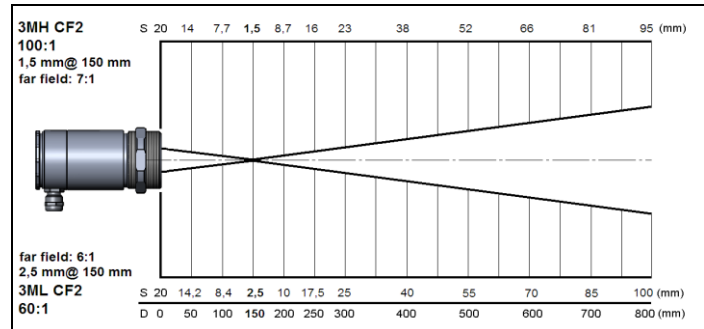

3MH

Optics: CF3

D:S (focus distance) = 100:1/ 2mm@ 200mm

D:S (far field) = 9:1

3ML

Optics: CF3

D:S (focus distance) = 60:1/ 3.4mm@ 200mm

D:S (far field) = 8:1

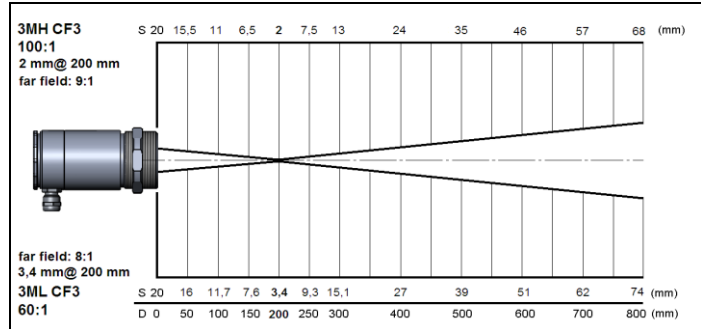

3MH

Optics: CF4

D:S (focus distance) = 100:1/ 4.5mm@ 450mm

D:S (far field) = 19:1

3ML

Optics: CF4

D:S (focus distance) = 60:1/ 7.5mm@ 450mm

D:S (far field) = 17:1

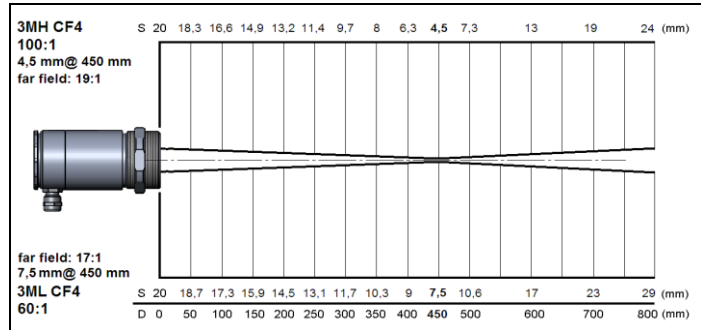

MT/ MTH/ F2/ F2H/ F6/ F6H/ G5L/ G5HF/

G5H1F/ G7/ P7 Optics: SF

D:S (focus distance) = 45:1/ 27mm@1200mm

D:S (far field) = 25:1

G5H Optics: SF

D:S (focus distance) = 70:1/ 17mm@1200mm

D:S (far field) = 33:1

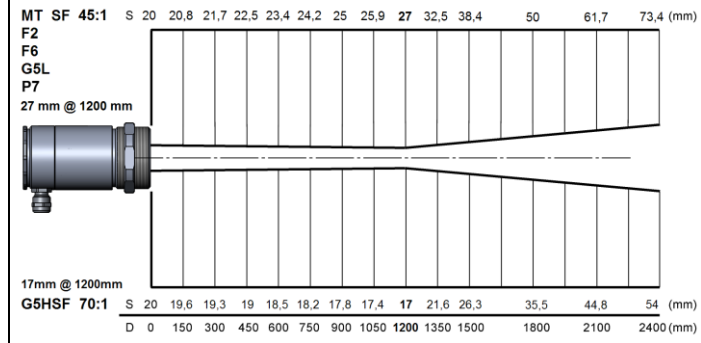

MT/ MTH/ F2/ F2H/ F6/ F6H/ G5L/ G5HF/

G5H1F/ G7/ P7 Optics: CF1

D:S (focus distance) = 45:1/ 1.6mm@70mm

D:S (far field) = 3:1

G5H Optics: CF1

D:S (focus distance) = 70:1/ 1mm@70mm

D:S (far field) = 3.4:1

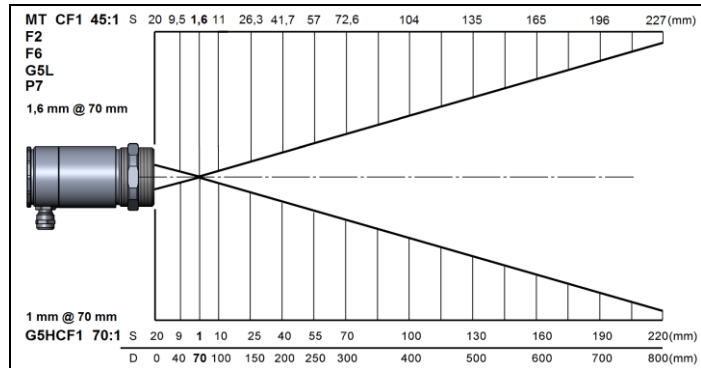

MT/ MTH/ F2/ F2H/ F6/ F6H/ G5L/ G5HF/

G5H1F/ G7/ P7

Optics: CF2

D:S (focus distance) = 45:1/ 3.4mm@150mm

D:S (far field) = 6:1

G5H

Optics: CF2

D:S (focus distance) = 70:1/ 2.2mm@150mm

D:S (far field) = 6.8:1

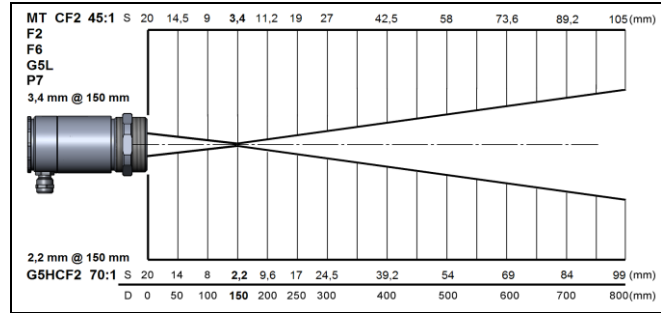

MT/ MTH/ F2/ F2H/ F6/ F6H/ G5L/ G5HF/

G5H1F/ G7/ P7

Optics: CF3

D:S (focus distance) = 45:1/ 4.5mm@200mm

D:S (far field) = 8:1

G5H

Optics: CF3

D:S (focus distance) = 70:1/ 2.9mm@200mm

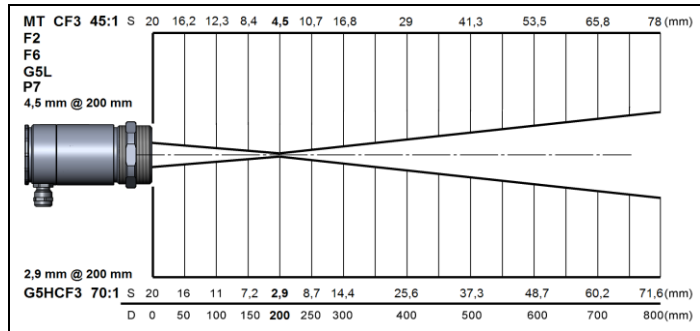

MT/ MTH/ F2/ F2H/ F6/ F6H/ G5L/ G5HF/

G5H1F/ G7/ P7

Optics: CF4

D:S (focus distance) = 45:1/ 10mm@450mm

D:S (far field) = 15:1

G5H

Optics: CF4

D:S (focus distance) = 70:1/ 6.5mm@450mm

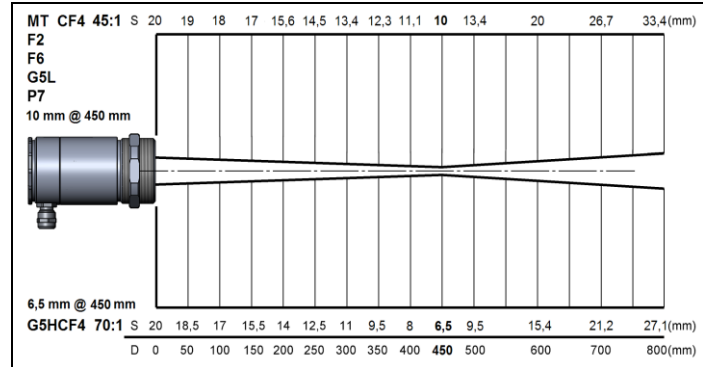

4ML

Optics: FF

D:S (focus distance) = 30:1/ 120mm@3600mm

D:S (far field) = 25:1

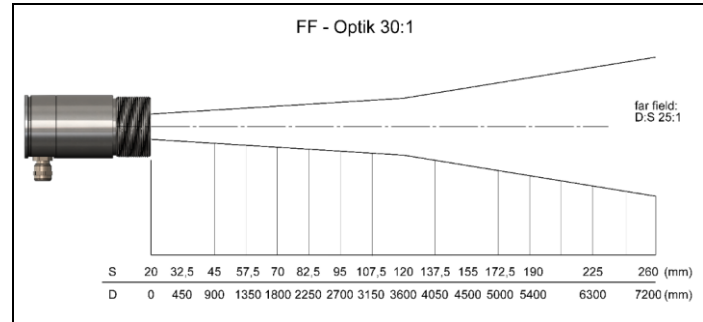

4ML

Optics: SF

D:S (focus distance) = 30:1/ 36,7mm@1100mm

D:S (far field) = 20:1

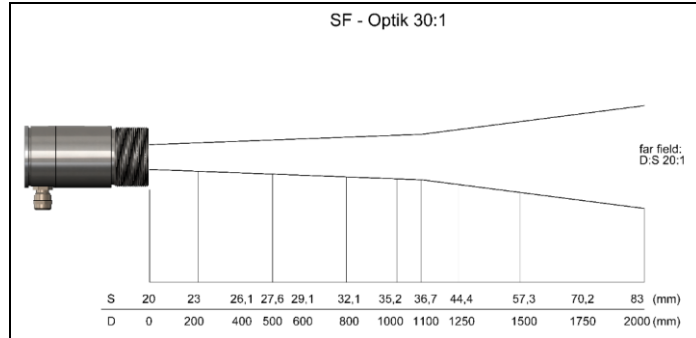

4ML

Optics: CF1

D:S (focus distance) = 30:1/ 2,4mm@70mm

D:S (far field) = 3:1

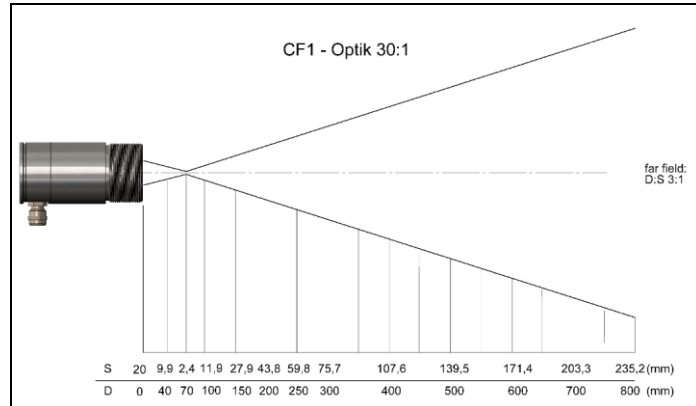

4ML

Optics: CF2

D:S (focus distance) = 30:1/ 5mm@150mm

D:S (far field) = 6:1

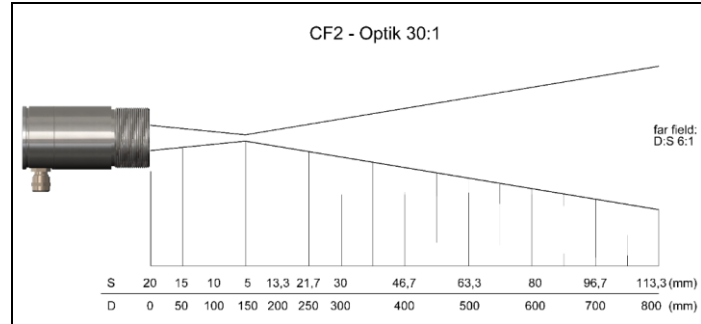
**4ML**

Optics: CF3

D:S (focus distance) = 30:1/ 6,7mm@200mm

D:S (far field) = 8:1

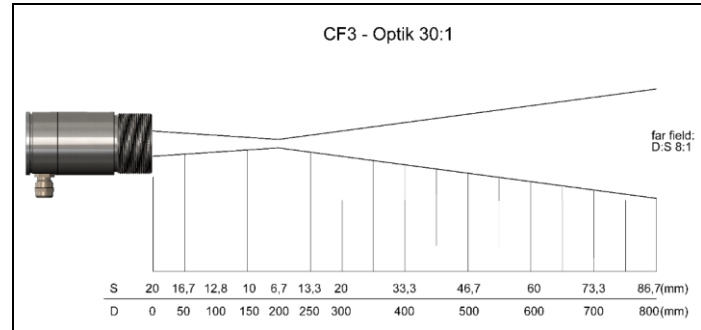

4ML

Optics: CF4

D:S (focus distance) = 30:1/ 15mm@450mm

D:S (far field) = 15:1

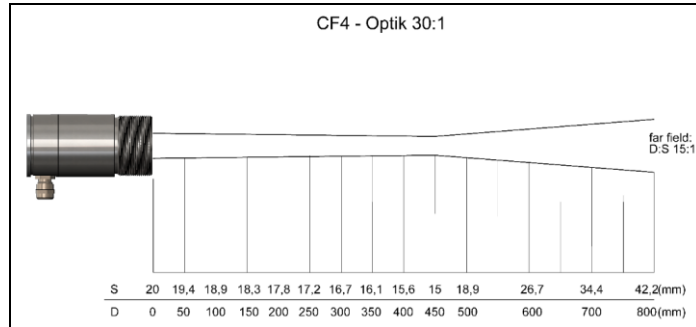

3 Mechanical Installation



- Keep the optical path free of any obstacles.
- For an exact alignment of the head to the object activate the integrated double laser.
[► 5.2 Aiming laser]

The CTlaser is equipped with a metric M48x1.5 thread and can be installed either directly via the sensor thread or with help of the supplied mounting nut (standard) and fixed mounting bracket (standard) to a mounting device available.

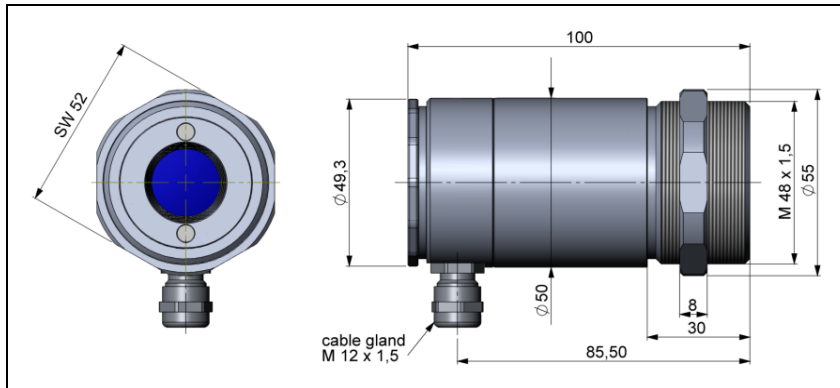

Figure 1: CTlaser sensing head

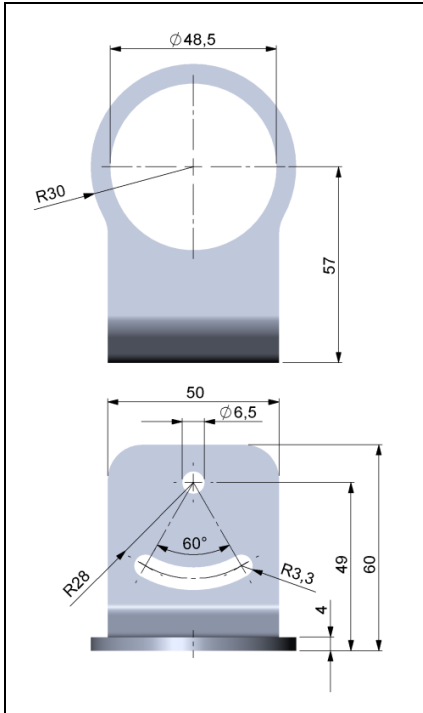

Figure 2: Mounting bracket, adjustable in one axis [Order No. - ACCTLFB] – standard scope of supply

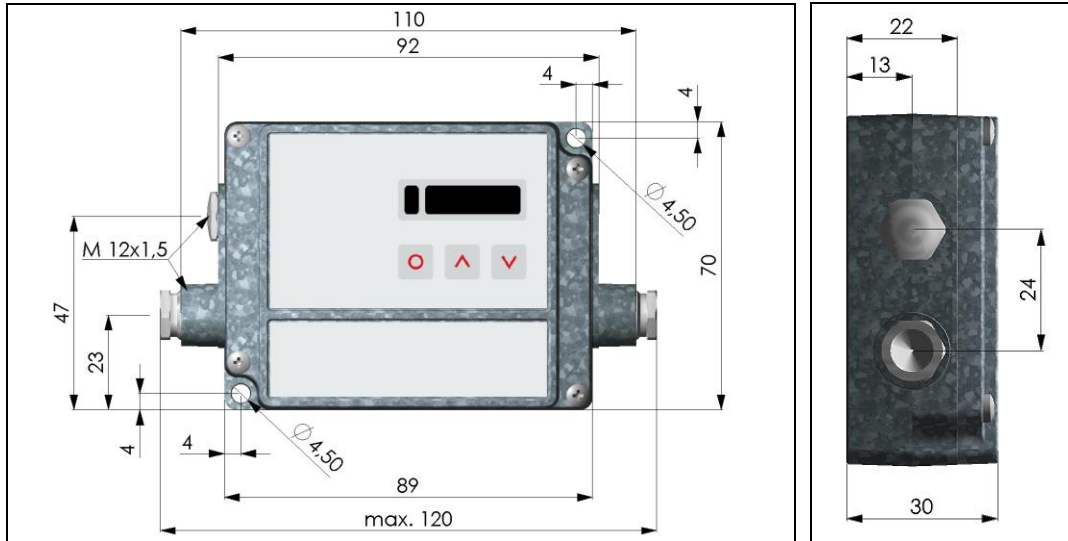

Figure 3: Electronic box

3.1 Accessories

3.1.1 Air purge collar



- Use oil-free, technically clean air only.
- The needed amount of air (approx. 40...120 l/ min.) and pressure (approx. 1,1...8 bar) depends on the application and the installation conditions on-site.

The lens must be kept clean at all times from dust, smoke, fumes and other contaminants in order to avoid reading errors. These effects can be reduced by using an air purge collar.

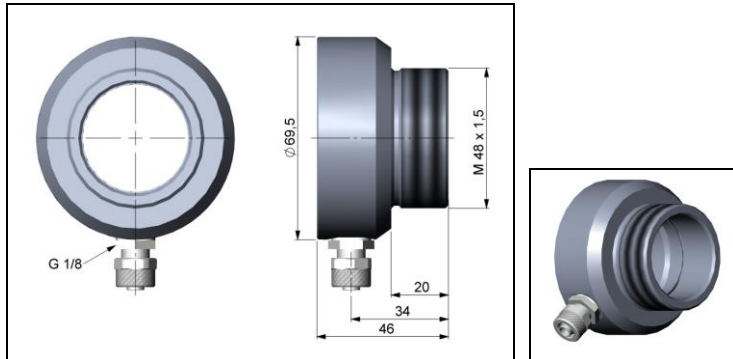

Figure 4: Air purge collar [Order No.: ACCTLAP], hose connection: 6x8 mm, thread (fitting): G 1/8 inch

3.1.2 Mounting bracket

This adjustable mounting bracket allows an adjustment of the sensor head in two axes.

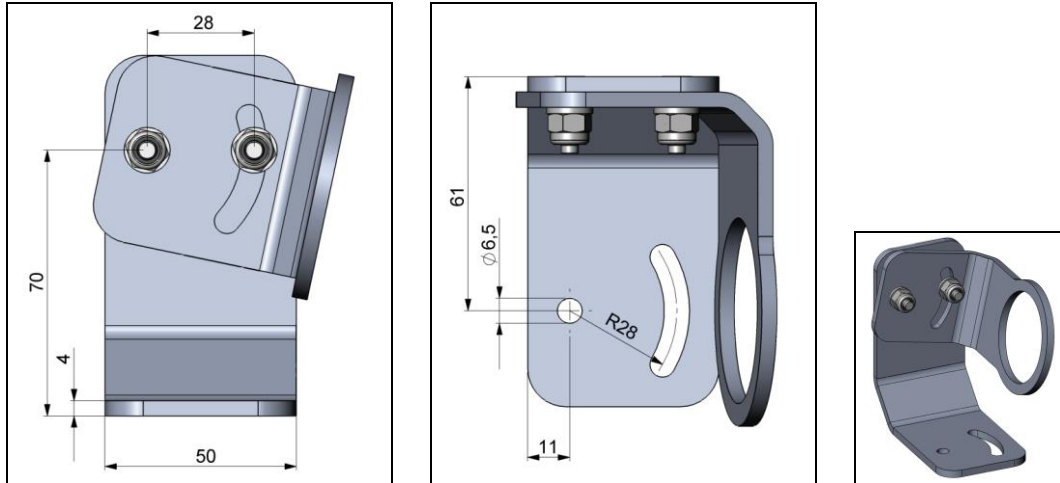

Figure 5: Mounting bracket, adjustable in two axes [Order No.: ACCTLAB]

3.1.3 Water cooled housing



To avoid condensation on the optics an air purge collar is recommended.

The sensing head is for application at ambient temperatures up to 85 °C. For applications at higher ambient temperatures we recommend the usage of the optional water cooled housing (operating temperature up to 175 °C) and the optional high temperature cable (operating temperature up to 180 °C).

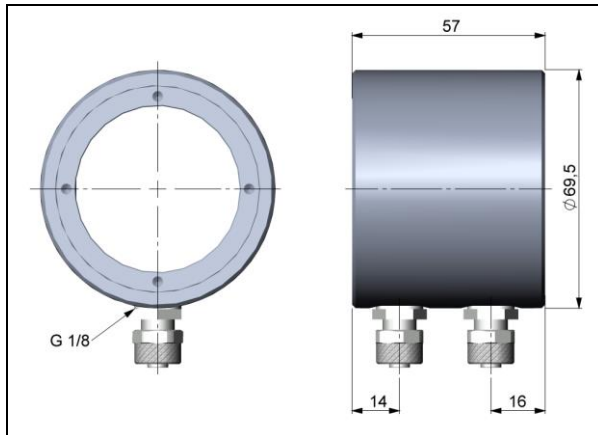

Water flow rate: approx. 3...5 l/ min
Water pressure: approx. 3...10 bar
(Cooling water temperature should not exceed 30 °C)



Figure 6: Water cooled housing [Order No.: ACCTLW], hose connection: 6x8 mm, thread (fitting): G 1/8 inch

3.1.4 Rail mount adapter for electronic box

With the rail mount adapter the CTlaser electronics can be mounted easily on a DIN rail (TS35) according EN50022.

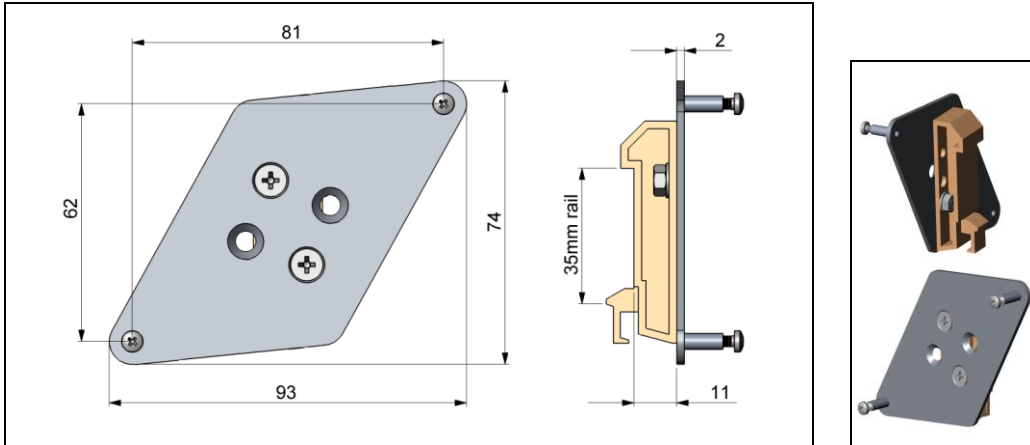
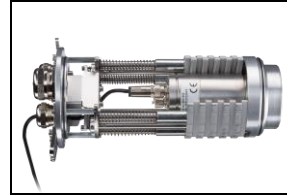

Figure 7: Rail mount adapter [Order No.: ACCTRAIL]

3.1.5 CoolingJacket Advanced

For very high ambient temperatures (up to 315 °C) the **CoolingJacket Advanced** (cooling housing) is provided.

Order No.: ACCXLCJA



For detailed information see installation manual.

3.1.6 Outdoor protective housing

The CTlaser LT models and the USB server can also be used for outdoor applications by using the outdoor protective housing (**Order No.: ACCTLOPH24ZNS**).

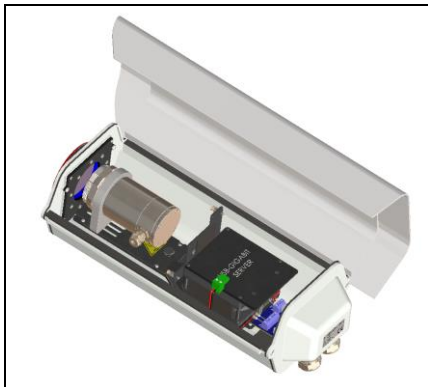

Figure 8: Outdoor protective housing for CTlaser LT with integrated heater, incl. prot. window (ZnS) and air purge collar/ 24 V DC



Figure 9: Outdoor protective housing with wall mount



For detailed information see installation manual.

3.1.7 IR app Connector

The IR App Connector is used to connect the sensor to a smartphone or tablet (► **6 IRmobile app**). The connector cable can be also used for the connection to your PC in combination with the software CompactConnect which can be downloaded for free under <https://www.optris.global/downloads-software>.

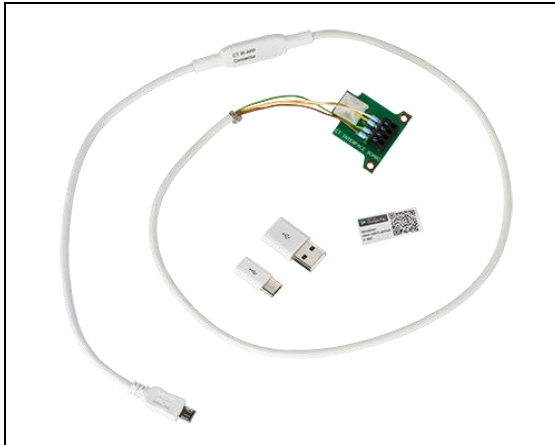

Figure 10: IR app Connector: USB programming adaptor [Order No.: **ACCTIAC** (for CTlaser 4M: **ACCTMIAC**)]

4 Electrical Installation

4.1 Connection of the cables



- For the Cooling jacket the connector version is needed.
- Connector Kit: Subsequent conversion of a standard CTlaser sensor into the connector version (**Order No.: ACCTLCONK**).

4.1.1 Basic version

The basic version is supplied with a connection cable (connection sensing head-electronics). For the electrical installation of the CTlaser open at first the cover of the electronic box (4 screws). Below the display are the screw terminals for the cable connection.



Figure 11: Basic version

4.1.2 Connector version



Use the original ready-made, fitting connection cables which are optionally available. Consider the pin assignment of the connector (see **Figure 13**).

This version has a connector plug integrated in the sensor backplane



Figure 12: Connector version

4.1.3 Pin assignment of connector plug (connector version only)

PIN	Designation	Wire color (original sensor cable)
1	Detector signal (+)	Yellow
2	Temperature probe head	Brown
3	Temperature probe head	White
4	Detector signal (-)	Green
5	Ground Laser (-)	Grey
6	Power supply Laser (+)	Pink
7	--	Not used

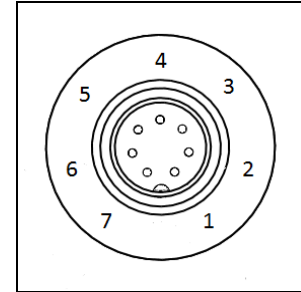

Figure 13: Connector plug (exterior view)

4.1.4 Designation [models LT/ LTF/ MT/ F2/ F6/ G5/ G7/ P7]

+8...36 VDC	Power supply
GND	Ground (0 V) of power supply
GND	Ground (0 V) of internal in- and outputs
OUT-AMB	Analog output head temperature (mV)
OUT-TC	Analog output thermocouple (J or K)
OUT-mV/mA	Analog output object temperature (mV or mA)
F1-F3	Functional inputs
AL2	Alarm 2 (Open collector output)
3V SW	PINK/ Power supply Laser (+)
GND	GREY/ Ground Laser (-)
BROWN	Temperature probe head
WHITE	Temperature probe head
GREEN	Detector signal (-)
YELLOW	Detector signal (+)

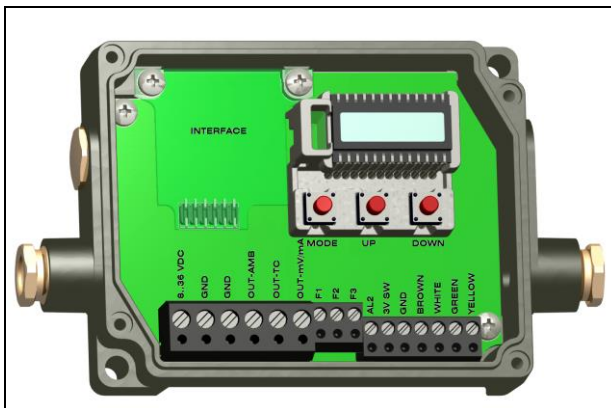

Figure 14: Opened electronic box (LT/ LTF/ MT/ F2/ F6/ G5/ G7/ P7) with terminal connections

4.1.5 Designation [models 05M/ 1M/ 2M/ 3M]

+8...36 VDC	Power supply
GND	Ground (0 V) of power supply
GND	Ground (0 V) of internal in- and outputs
AL2	Alarm 2 (Open collector output)
OUT-TC	Analog output thermocouple (J or K)
OUT-mV/mA	Analog output object temperature (mV or mA)
F1-F3	Functional inputs
GND	Ground (0 V)
3V SW	PINK/ Power supply Laser (+)
GND	GREY/ Ground Laser (-)
BROWN	Temperature probe head
WHITE	Temperature probe head
GREEN	Detector signal (-)
YELLOW	Detector signal (+)

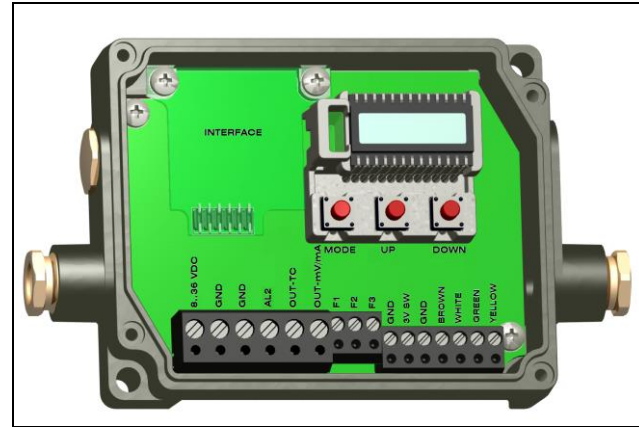

Figure 15: Opened electronic box (05M/ 1M/ 2M/ 3M) with terminal connections

4.1.6 Designation [models 4M]

+8...30 VDC	Power supply
GND	Ground (0 V) of power supply
GND	Ground (0 V) of internal in- and outputs
AL2	Alarm 2 (Open collector output)
OUT-1	Analog output mA, mV, TCK
OUT-2	Analog output mA, mV, TCK
I/O1-I/O3	In- and outputs
GND	Ground (0 V)
Pink	3 VDC, switchable, for laser-sightingtool
Gray	Ground of PIN pink
BROWN	Temperature probe head (NTC)
WHITE	Head ground
GREEN	Head power
YELLOW	Detector signal

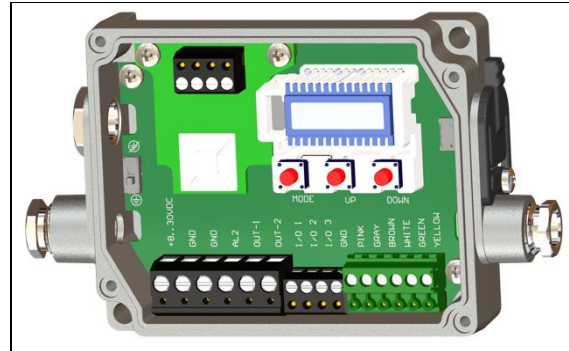

Figure 16: Opened electronic box (4M) with terminal connections

4.2 Power supply



Do never connect a supply voltage to the analog outputs as this will destroy the output! The CTlaser is not a 2-wire sensor!



Use a separate, stabilized power supply unit with an output voltage in the range of **8–36 VDC** (CTlaser 4M: **8–30 VDC**) which can supply **160 mA**. The residual ripple should be max **200 mV**.

4.3 Cable assembling



For all power and data lines use shielded cables only. The sensor shield has to be grounded.

The cable gland M12x1.5 allows the use of cables with a diameter of 3 to 5 mm.

1. Remove the isolation from the cable (40 mm power supply, 50 mm signal outputs, 60 mm functional inputs), cut the shield down to approximately 5 mm and spread the strands out.
2. Extract about 4 mm of the wire isolation and tin the wire ends. Place the pressing screw, the rubber washer and the metal washers of the cable gland one after the other onto the prepared cable end (see **Figure 17**).

3. Spread the strands and fix the shield between two of the metal washers.
4. Insert the cable into the cable gland until the limit stop and screw the cap tight. Every single wire may be connected to the according screw clamps according to their colors.

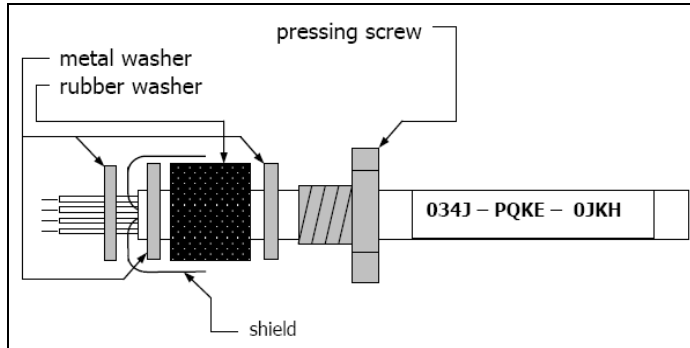

Figure 17: Cable assembling

4.4 Ground connection

4.4.1 05M, 1M, 2M, 3M models

At the bottom side of the mainboard PCB you will find a connector (jumper) which has been placed from factory side as shown in the picture [**bottom** and **middle** pin connected]. In this position the ground connections (GND power supply/ outputs) are connected with the ground of the electronics housing.

To avoid ground loops and related signal interferences in industrial environments it might be necessary to interrupt this connection. To do this put the jumper in the opposite position [**middle** and **top** pin connected].

If the thermocouple output is used the connection GND – housing should be interrupted generally.

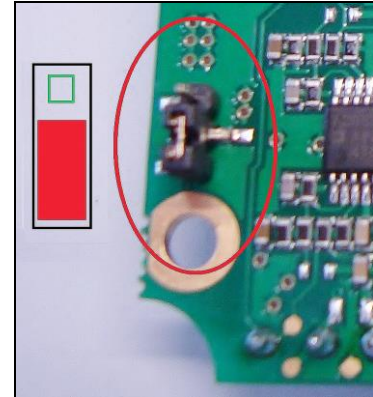

Figure 18: Ground connection

4.4.2 4M model

On the left side of the mainboard PCB you will find a black switch which is connecting factory-default the ground connections (GND power supply/ outputs) with the ground of the electronics housing.

To avoid ground loops and related signal interferences in industrial environments it might be necessary to interrupt this connection. For this purpose, the switch must be changed.



Figure 19: Ground connection

4.4.3 LT, LTF, MT, F2, F6, G5, G7, P7 models

At the bottom side of the mainboard PCB you will find a connector (jumper) which has been placed from factory side as shown in the picture [**left** and **middle** pin connected]. In this position the ground connections (GND power supply/ outputs) are connected with the ground of the electronics housing.

To avoid ground loops and related signal interferences in industrial environments it might be necessary to interrupt this connection. To do this put the jumper in the other position [**middle** and **right** pin connected].

If the thermocouple output is used the connection GND – housing should be interrupted generally.

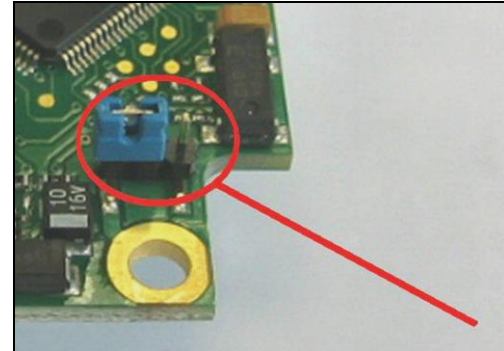

Figure 20: Ground connection

4.5 Exchange of the sensing head



- After exchanging a head the calibration code of the new head must be entered into the electronics.
- After modification of the code a reset is necessary to activate the changes. **[▶ 5 Operation]**
- The calibration code is fixed on a label on the head. Do not remove this label or note the code. The code is needed if the electronic must be exchanged.
- The sensing head of the **CTlaser 4M** cannot be exchanged.

The sensing head is already connected to the electronics by factory default. Inside a certain model group an exchange of sensing heads and electronics is possible.

Entering of the calibration code

Every head has a specific calibration code, which is printed on the head. For a correct temperature measurement and functionality of the sensor this calibration code must be stored into the electronic box. The calibration code consists of five blocks with 4 characters each.

Example: **EKJ0 – 00UD – 0A1B – A17U – 93OZ**
 block 1 block 2 block 3 block 4 block 5

To enter the code press the **Up** and **Down** key (keep pressed) and then the **Mode** key. The display shows **HCODE** and then the 4 signs of the first block. With **Up** and **Down** each sign can be changed. **Mode** switches to the next sign or next block.



Figure 21: Sensing head

4.6 Exchange of the head cable



To avoid influences on the accuracy use an exchange cable with the same wire profiles and specification like the original one.

The sensing head cable can also be exchanged if necessary.

1. For a dismantling on the head side open the cover plate on the back side of the head first. Then remove the terminal block and loose the connections.
2. After the new cable has been installed proceed in reversed order. Be careful the cable shield is properly connected to the head housing.

4.7 Outputs and Inputs

4.7.1 Analog outputs

The CTlaser has two analog output channels. With the CTlaser 4M the outputs are freely selectable.



Consider that there are different connection pins on the mainboard (**OUT-mV/mA** or **OUT-TC**) according to the chosen output signal.

Output channel 1

This output is used for the object temperature. The selection of the output signal can be done via the programming keys [**►5 Operation**]. The CompactConnect software allows the programming of output channel 1 as an alarm output.

Output signal	Range	Connection pin on CTlaser board
Voltage	0 ... 5 V	OUT-mV/mA
Voltage	0 ... 10 V	OUT-mV/mA
Current	0 ... 20 mA	OUT-mV/mA
Current	4 ... 20 mA	OUT-mV/mA
Thermocouple	TC J	OUT-TC
Thermocouple	TC K	OUT-TC

Output channel 2 [on LT/ G5/ G7/ P7 only]

The connection pin OUT AMB is used for output of the head temperature [-20–180 °C as 0–5 V or 0–10 V **signal**]. The CompactConnect software allows the programming of output channel 2 as an alarm output. Instead of the head temperature T_{Head} also the object temperature T_{Obj} or electronic box temperature T_{Box} can be selected as alarm source.

4.7.2 Digital Interfaces



The Ethernet interface requires a minimum 12 V supply voltage. Pay attention to the notes on the according interface manuals.

CTlaser sensors can be optionally equipped with an USB-, RS232-, RS485-, Profibus DP-*, Modbus RTU-* or Ethernet-interface.

1. To install an interface, plug the interface board into the place provided, which is located beside the display. In the correct position the holes of the interface match with the thread holes of the electronic box.
2. Press the board down to connect it and use both M3x5 screws for fixing. Plug the preassembled interface cable with the terminal block into the male connector of the interface board.

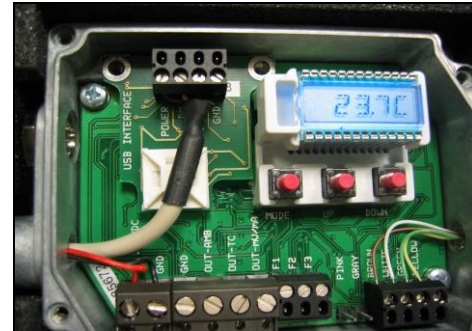

Figure 22: Digital interfaces

* Not for CTlaser 4M available

4.7.3 Relay outputs



- The switching thresholds are in accordance with the values for alarm 1 and 2 [**►4.7.6 Alarms**]. The alarm values are set according to the **►2.1 Factory settings**. For advanced settings (change of low- and high alarm) a digital interface (USB, RS232) and the software is needed.
- A simultaneous installation of a digital interface and the relay outputs is not possible.

The CTlaser can optionally be equipped with a relay output. The relay board will be installed in the same way as the digital interfaces.

The relay board provides two fully isolated switches, which have the capability to switch max 60 VDC/ 42 VAC_{RMS}, 0.4 A, DC/AC. A red LED shows the closed switch.

4.7.4 Functional inputs (not for CTlaser 4M)

The three functional inputs F1 – F3 can be programmed with the CompactConnect software, only.

F1 (digital):	trigger (a 0 V level on F1 resets the hold functions)
F2 (analog):	external emissivity adjustment [0–10 V ► $\epsilon = 0.1$; 9 V ► $\epsilon = 1$; 10 V ► $\epsilon = 1,1$]
F3 (analog):	external compensation of ambient temperature/ the range is scalable via software [0–10 V ► -40–900 °C/ pre-set range: -20–200 °C]
F1-F3 (digital):	emissivity (digital choice via table)
	<p>A non-connected input represents: F1 = High F2, F3 = Low [High level: $\geq +3 \text{ V} \dots +36 \text{ V}$ Low level: $\leq +0,4 \text{ V} \dots -36 \text{ V}$]</p>

4.7.5 I/O Pins (only for CTlaser 4M)

The CT 4M has three digital pins which can be programmed as outputs (digital) or as inputs (digital or analog) using the CompactPlus Connect software. The following functions are available:

Function	I/O pin acts as	Description
Alarm	Output digital	Open collector output/ definition as High- or Low alarm via norm. open/ norm. close options in software dialog.
Valid Low	Input digital	The output follows the object temperature as long as there is a Low level at the I/O pin. After discontinuation of the Low level the last value will be held.
Valid High	Input digital	The output follows the object temperature as long as there is a High level at the I/O pin. After discontinuation of the High level the last value will be held.
Hold Low-High	Input digital	The last value will be held if there is a signal with a rising edge on the I/O pin.
Hold High-Low	Input digital	The last value will be held if there is a signal with a falling edge on the I/O pin.

Hold Reset Low	Input digital	Reset of Peak or valley hold (High-Low signal)
Hold Reset High	Input digital	Reset of Peak or valley hold (Low-High signal)
Emissivity external	Input analog	The emissivity value can be adjusted via a 0-10 V signal on the I/O pin (scaling possible via software).
Uncommitted value	Input analog	Display of a uncommitted value
Laser on Low	Input digital	Turning on the laser (Low signal)
Laser on High	Input digital	Turning on the laser (High signal)
External Ambient Compensation	Input analog	The ambient temperature will be determined by a voltage on the I/O-pin [0–10 V; range scalable].
External Transmitted Radiation	Input analog	The transmitted ambient temperature will be determined by a voltage on the I/O-pin [0–10 V; range scalable].

Low/High-level: Via software

4.7.6 Alarms



All alarms (alarm 1, alarm 2, output channel 1 and 2 if used as alarm output) have a fixed **hysteresis of 2 K**.

The CTlaser has the following Alarm features:

Output channel 1 and 2 [channel 2 on LT/ G5/ G7/ P7 only]

To activate, the according output channel has to be switched into digital mode. For this purpose the software CompactConnect is required.

Visual alarms

These alarms will cause a change of the color of the LCD display and will also change the status of the optional relays interface. In addition the Alarm 2 can be used as open collector output at pin **AL2** on the mainboard [**24 V / 50 mA**].

The alarms are defined as follows by factory default:

Both alarms affect the color of the LCD display:

BLUE: alarm 1 active

RED: alarm 2 active

GREEN: no alarm active

Alarm 1 **Normally closed/ Low-Alarm**

Alarm 2 **Normally open/ High-Alarm**

For extended setup like definition as low or high alarm **[via change of normally open/ closed]**, selection of the signal source [T_{Obj} , T_{Head} , T_{Box}] a digital interface (e.g. USB, RS232) including the software CompactConnect is needed.



On the CTlaser model 4M both outputs are freely selectable. Analog mA/mV, Alarm mA/mV and TCK are available.

4.7.7 Open collector output / AL2

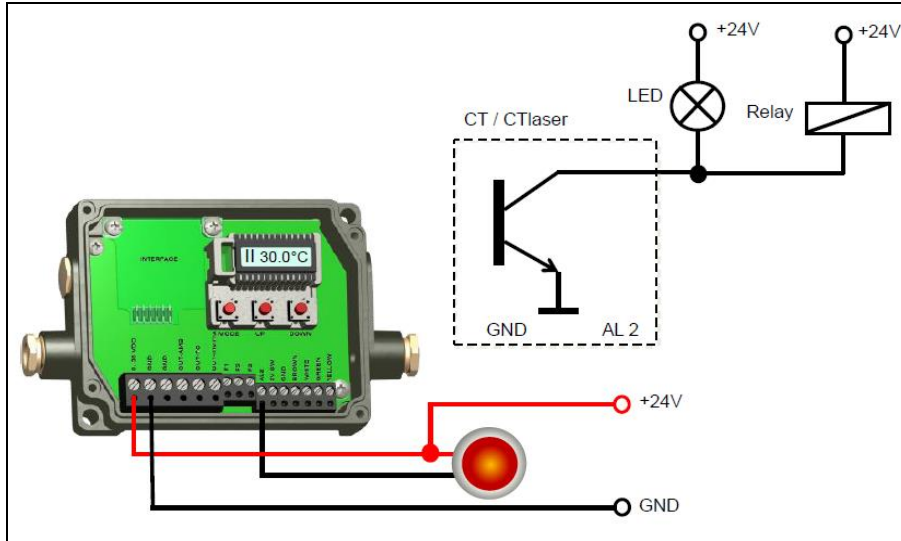

- The transistor acts as a switch. In case of alarm, the contact is closed.
- A load/consumer (Relay, LED or a resistor) must always be connected.
- The alarm voltage (here 24V) must not be connected directly to the alarm output (short circuit).

5 Operation

After power up the unit the sensor starts an initializing routine for some seconds. During this time the display will show **INIT**. After this procedure the object temperature is shown in the display. The display backlight color changes accordingly to the alarm settings [► 4.7.6 Alarms].

5.1 Sensor setup



- Pressing the Mode button again recalls the last called function on the display. The signal processing features **Peak hold** and **Valley hold** cannot be selected simultaneously.
- To set the CTlaser back to the factory default settings, press at first the Down-key and then the Mode-key and keep both pressed for approx. 3 seconds. **RESET** appears as confirmation in the display.

The programming keys **Mode**, **Up** and **Down** enable the user to set the sensor on-site. The current measuring value or the chosen feature is displayed. With **Mode** the operator obtains the chosen feature, with **Up** and **Down** the functional parameters can be selected – **a change of parameters will have immediate effect**. If no key is pressed for more than 10 seconds the display automatically shows the calculated object temperature (according to the signal processing).

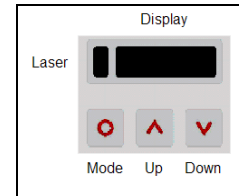

Figure 23: Display of the device

Display	Mode [Sample]	Adjustment Range
S ON	Laser Sighting [On]	ON/ OFF
142.3C	Object temperature (after signal processing) [142,3 °C]	fixed
127CH	Head temperature [127 °C]	fixed
25CB	Box temperature [25 °C]	fixed
142CA	Current object temperature [142 °C]	fixed
δ MV5	Signal output channel 1 [0-5 V]	δ 0-20 = 0–20 mA/ δ 4-20 = 4–20 mA/ δ MV5 = 0–5 V/ δ MV10 = 0-10 V/ δ TCJ = thermocouple type J/ δ TCK = thermocouple type K
E0.970	Emissivity [0,970]	0,100 ... 1,100
T1.000	Transmissivity [1,000]	0,100 ... 1,100
A 0.2	Signal output Average [0,2 s]	A---- = inactive/ 0,1 ... 999,9 s
P----	Signal output Peak hold [inactive]	P---- = inactive/ 0,1 ... 999,9 s / P oo oo oo oo = infinite
V----	Signal output Valley hold [inactive]	V---- = inactive/ 0,1 ... 999,9 s / V oo oo oo oo = infinite
u 0.0	Lower limit temperature range [0 °C]	depending on model / inactive at TCJ- and TCK-output
n 500.0	Upper limit temperature range [500 °C]	depending on model / inactive at TCJ- and TCK-output
[0.00	Lower limit signal output [0 V]	according to the range of the selected output signal
] 5.00	Upper limit signal output [5 V]	according to the range of the selected output signal
U °C	Temperature unit [°C]	°C/ °F
 30.0	Lower alarm limit [30 °C]	depending on model
 100.0	Upper alarm limit [100 °C]	depending on model
XHEAD	Ambient temperature compensation [head temperature]	XHEAD = head temperature/ -40,0 ... 900,0 °C (for LT) as fixed value for compensation/ returning to XHEAD (head temperature) by pressing Up and Down together
M 01	Multidrop adress [1] (only with RS485 interface) RS422 mode	01 ... 32 RS422 (Press Down button on M01)
B 9.6	Baud rate in kBaud [9,6]	9,6/ 19,2/ 38,4/ 57,6/ 115,2 kBaud

Table 2: Sensor settings

- S ON** Activating (**ON**) and Deactivating (**OFF**) of the **Sighting Laser**. By pressing **Up** or **Down** the laser can be switched on and off.
- δ MV5** Selection of the **Output signal**. By pressing **Up** or **Down** the different output signals can be selected (see **Table 2**).
- E0.970** Setup of **Emissivity**. Pressing **Up** increases the value, **Down** decreases the value (also valid for all further functions). The emissivity is a material constant factor to describe the ability of the body to emit infrared energy [**► 9 Emissivity**].
- T1.000** Setup of **Transmissivity**. This function is used if an optical component (protective window, additional optics e.g.) is mounted between sensor and object. The standard setting is 1.000 = 100 % (if no protective window etc. is used).
- A 0.2** Setup of **Average time**. In this mode an arithmetic algorithm will be performed to smoothen the signal. The set time is the time constant. This function can be combined with all other post processing functions. The shortest value is 0.001 s and can be increased/ decreased only by values of the power series of 2 (0.002, 0.004, 0.008, 0.016, 0.032, ...). If the value is set to **0.0** the display will show --- (function deactivated).
- P----** Setup of **Peak hold**. If the value is set to **0.0** the display will show --- (function deactivated). In this mode the sensor is waiting for descending signals. If the signal descends the algorithm maintains the previous signal peak for the specified time.

After the hold time the signal will drop down to the second highest value or will descend by 1/8 of the difference between the previous peak and the minimum value during the hold time. This value will be held again for the specified time. After this the signal will drop down with slow time constant and will follow the current object temperature.

V---

Setup of **Valley hold**. If the value is set to **0.0** the display will show --- (function deactivated). In this mode the sensor waits for ascending signals. The definition of the algorithm is according to the peak hold algorithm (inverted).

Signal graph
with **P----**

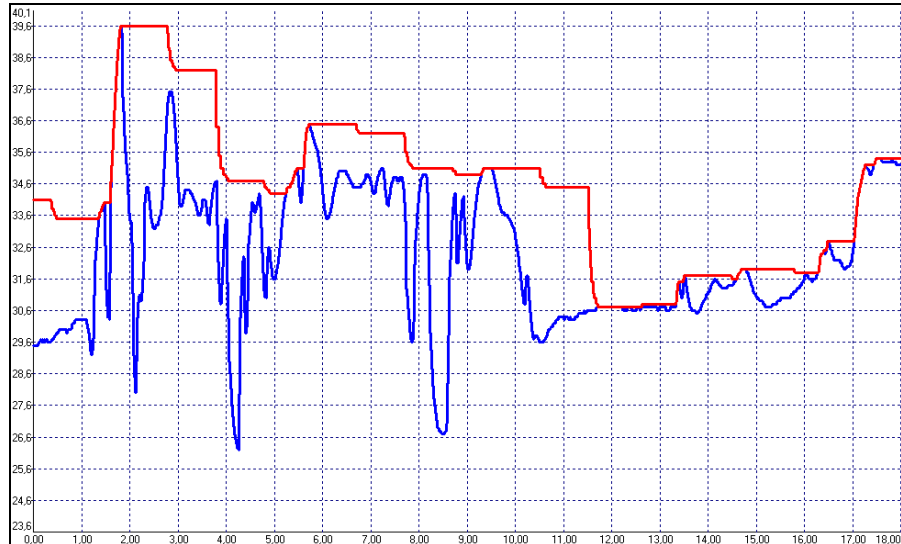

— **T_{Process} with Peak Hold (Hold time = 1s)**

— **T_{Actual} without post processing**

u 0.0

Setup of the **Lower limit of temperature range**. The minimum difference between lower and upper limit is **20 K**. If you set the lower limit to a value \geq upper limit the upper limit will be adjusted to **[lower limit + 20 K]** automatically.

- n 500.0** Setup of the **Upper limit of the temperature range**. The minimum difference between upper and lower limit is **20 K**. The upper limit can only be set to a value = lower limit + 20 K.
- [0.00** Setup of the **Lower limit of the signal output**. This setting allows an assignment of a certain signal output level to the lower limit of the temperature range. The adjustment range corresponds to the selected output mode (e.g. 0-5 V).
-] 5.00** Setup of the **Upper limit of the signal output**. This setting allows an assignment of a certain signal output level to the upper limit of the temperature range. The adjustment range corresponds to the selected output mode (e.g. 0-5 V).
- U °C** Setup of the **Temperature unit** [°C or °F].
- | 30.0** Setup of the **Lower alarm limit**. This value corresponds to Alarm 1 **[▶4.7.6 Alarms]** and is also used as threshold value for relay 1 (if the optional relay board is used).
- || 100.0** Setup of the **Upper alarm limit**. This value corresponds to Alarm 2 **[▶4.7.6 Alarms]** and is also used as threshold value for relay 2 (if the optional relay board is used).

XHEAD

Especially if there is a big difference between the ambient temperature at the object and the head temperature the use of **ambient temperature compensation** is recommended.

Setup of the **Ambient temperature compensation**. In dependence on the emissivity value of the object a certain amount of ambient radiation will be reflected from the object surface. To compensate this impact, this function allows the setup of a fixed value which represents the ambient radiation. If **XHEAD** is shown the ambient temperature value will be taken from the head-internal probe. To return to **XHEAD** press **Up** and **Down** together.

M 01

Setup of the **Multidrop address**. In a RS485 network each sensor will need a specific address. This menu item will only be shown if a RS485 interface board is plugged in. For using the **RS422** mode, press once the down button on M01.

B 9.6

Setup of the **Baud rate** for digital data transfer.

CTlaser 4M

Display	Mode [Sample]	Display
TPROC 320.9	Process temperature (after signal processing) [320,9 °C]	fixed
T INT 50.1	Detector Temperature [50,1 °C]	fixed
T BOX 38.6	Electronic box Temperature [38,6 °C]	fixed
EMISS 1.000	Emissivity [1,000]	0,100 ... 1,100
TRANS 1.000	Transmission [1,000]	0,100 ... 1,100
AVG 0.020	Signal output Average [0,020 s]	AVG 0.000 = inactive/ 0,1 ... 65 s
HOLD	OFF	OFF/ PEAK/ VALL/ APEAK/ AVALL
H TIM	PEAK/ VALL	0...65 s (65 = infinity)
H TH	APEAK/ AVALL	Starting temperature...end temperature
H HY	APEAK/ AVALL	Hysteresis setting in °C/°F
U °C	Temperature unit [°C]	°C/ °F
M 01	Multidrop address [1] (only with RS485 interface) RS422 mode	01 ... 32 RS422 (Press Down button on M01)
BAUD 115.2K	Baud rate in kBaud [115]	115.2 / 921.6 kBaud
S ON	Laser Sighting	ON/ OFF

EMISS 1.000 Setup of **Emissivity**. Pressing **Up** increases the value, **Down** decreases the value (also valid for all further functions). The emissivity is a material constant factor to describe the ability of the body to emit infrared energy **►9 Emissivity**].

TRANS 1.000 Setup of **Transmissivity**. This function is used if an optical component (protective window, additional optics e.g.) is mounted between sensor and object. The standard

setting is 1.000 = 100 % (if no protective window etc. is used).

AVG 0.020

Setup of **Average time**. In this mode an arithmetic algorithm will be performed to smoothen the signal. The set time is the time constant. This function can be combined with all other post processing functions. The shortest value is 0,001 s. If the value is set to **0.0** the function is deactivated.

HOLD

Setup of **signal processing**. By pressing **Up** or **Down** the mode can be selected.

PEAK: Setup of **Peak hold**. In this mode the sensor is waiting for descending signals. If the signal descends the algorithm maintains the previous signal peak for the specified time.

After the hold time the signal will drop down to the second highest value or will descend by 1/8 of the difference between the previous peak and the minimum value during the hold time. This value will be held again for the specified time. After this the signal will drop down with slow time constant and will follow the current object temperature.

If the value is set to **0.0** the display will show --- (function deactivated).

VALL: Setup of **Valley hold**. In this mode the sensor waits for ascending signals. The definition of the algorithm is according to the peak hold algorithm (inverted).

If the value is set to **0.0** the function deactivated.

APEAK (Advanced Peak Hold): In this mode the sensor waits for local peak values. Peak values which are lower than their predecessors will only be taken over if the temperature has fallen below the **Threshold** value beforehand. If **Hysteresis** is activated a peak in addition must decrease by the value of the hysteresis before the algorithm takes it as a new peak value.

AVALL (Advanced Valley Hold): This mode is the inverted function of Advanced Peak

hold. The sensor waits for local minima. Minimum values which are higher than their predecessors will only be taken over if the temperature has exceeded the **Threshold** value beforehand. If **Hysteresis** is activated a minima in addition must increase by the value of the hysteresis before the algorithm takes it as a new minimum value.

- U °C** Setup of the **Temperature unit** [°C or °F].
- M 01** Setup of the **Multidrop address**. In a **RS485** network each sensor will need a specific address. This menu item will only be shown if a RS485 interface board is plugged in. For using the **RS422** mode, press once the down button on M01.
- BAUD 115.2K** Setup of the **Baud rate** for digital data transfer.
- S OFF** Activating (**ON**) and Deactivating (**OFF**) of an optional **Sighting Laser** [**► 5.2 Aiming laser**]. By pressing **Up** or **Down** a voltage of 3 VDC will be switched to the **PINK** connection pin on the mainboard.

Peak picking function

For a detection of fast hotspots (detection time 90 µs) the averaging time must be set to 0.0 s.



You can display the process temperature TProc (with post processing) and also the current average temperature TAvG (without any post processing) in the diagram. In this way the result and functionality of the selected post processing features can easily be traced and controlled.

Signal Graphs

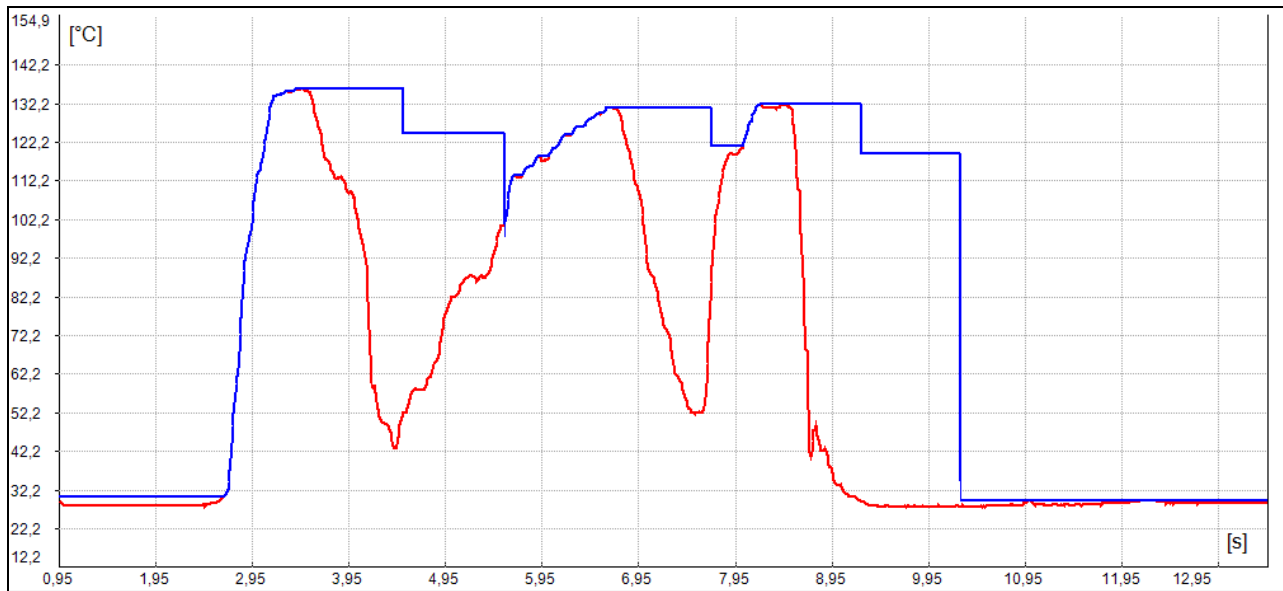

— T_{Proc} with Peak Hold (Hold time = 1s)

— T_{Avg} without post processing

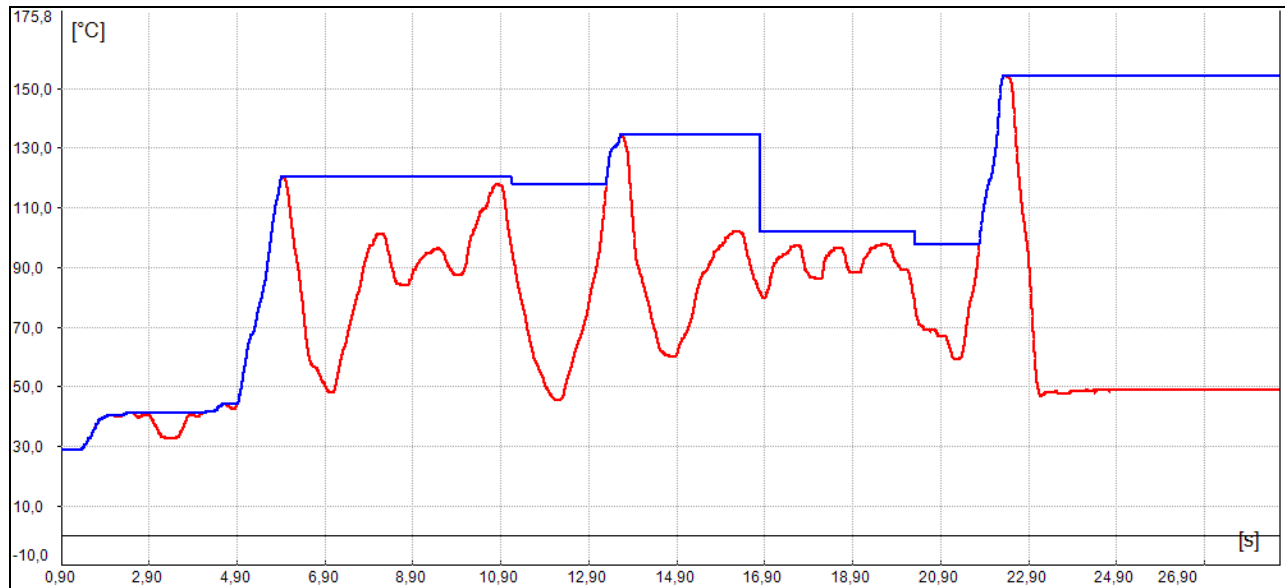

— T_{Proc} with Advanced peak hold (Threshold = 80 °C/ Hysteresis = 20 °C)

— T_{Avg} without post processing

5.2 Aiming laser

The CTlaser has an integrated double laser aiming which helps for the alignment of the sensor. Within the two laser points lies the measurement spot. At the focus point of the according optics [► 2.12 Optical charts] both lasers are crossing and showing as one dot the minimum spot. This enables an alignment of the sensor to the object.



Do not directly point the laser at the eyes of persons or animals! Do not stare into the laser beam. Avoid indirect exposure via reflective surfaces!



The two laser points mark the position of the measuring spot, but not its exact size. The exact size of the measurement spot can be found in the optical charts [► 2.12 Optical charts].



- At ambient temperatures $>50\text{ }^{\circ}\text{C}$ the laser will be switched off automatically.
- The laser should only be used for sighting and positioning of the sensor. A permanent use of the laser can reduce the lifetime of the laser diodes.
- Furthermore, in a permanent use of the laser, the measurement accuracy can be affected.



Figure 24: Identification of the laser

The laser can be activated/ deactivated via the programming keys on the unit or via the software. If the laser is activated a yellow LED is shining (beside temperature display).

5.3 Error messages

The display of the sensor can show the following error messages:

LT/ LTF/ MT/ F2/ F6/ G5/ G7/ P7 models:

OVER	Object temperature too high
UNDER	Object temperature too low
^^CH	Head temperature too high
vvCH	Head temperature too low

05M/ 1M/ 2M/ 3M models:

1. Digit:

0x	No error
1x	Head temperature probe short circuit to GND
2x	Box temperature too low
4x	Box temperature too high
6x	Box temperature probe disconnected
8x	Box temperature probe short circuit to GND

2. Digit:

x0	No error
x2	Object temperature too high
x4	Head temperature too low
x8	Head temperature too high
xC	Head temperature probe disconnected

6 IRmobile app

The CTlaser sensor has a direct connection to an Android smartphone or tablet. All you have to do is download the IRmobile app for free in the Google Play store. This can also be done via the QR code. An IR app connector is required for connection to the device (**Part-No.: ACCTIAC**).



With IRmobile you are able to monitor and analyse your infrared temperature measurement on a connected smartphone or tablet. This app works on most Android devices running 5.0 or higher with a micro USB or USB-C port supporting USB-OTG (On The Go). It is easy to operate: after you plug your CTlaser device to your phone or tablet, the app will start automatically. The device is powered by your phone. Different digital temperature values can be displayed in the temperature time diagram. You can easily zoom-in the diagram to see more details and small signal changes.

IRmobile app features:

- Temperature time diagram with zoom function
- Digital temperature values
- Setup of emissivity, transmissivity and other parameters
- Scaling of the analog output and setting of the alarm output
- Change of temperature unit: Celsius or Fahrenheit
- Saving/loading of configurations and T/t diagrams
- Restore factory default sensor settings
- Integrated simulator

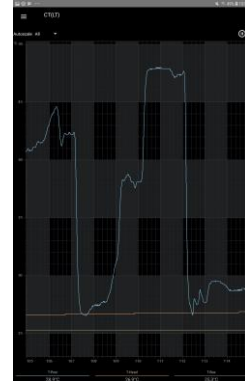
**Supported for:**

- Optris pyrometers: Compact series, high performance series and video thermometers
- Optris IR cameras: PI and Xi series
- For android devices running 5.0 or higher with a micro USB or USB-C port supporting USB-OTG (On The Go)

7 Software CompactConnect/ CompactPlus Connect

Minimum system requirements:



- Windows 7, 8, 10
- USB interface
- Hard disc with at least 30 MByte of free space
- At least 128 MByte RAM
- CD-ROM drive



- A detailed description is provided on the downloaded software package.
- Software CompactConnect for LT/ LTF/ 05M/ 1M/ 2M/ 3M/ MT/ F2/ F6/ G5/ G7/ P7
- Software CompactPlus Connect for 4M

7.1 Installation

The software can be downloaded under <https://www.optris.global/downloads-software>. Unzip and open the program and start the **CDsetup.exe**. Follow the instructions of the wizard until the installation is finished.

The installation wizard will place a launch icon on the desktop and in the start menu:

[Start]\Programs\CompactConnect or **[Start]\Programs\CompactPlus Connect**.

If you want to uninstall the software from your system, please use the **uninstall icon** in the start menu.

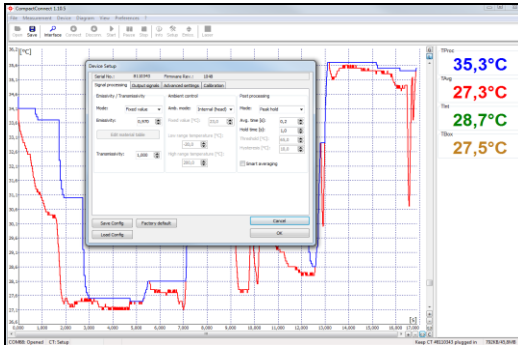

CompactConnect

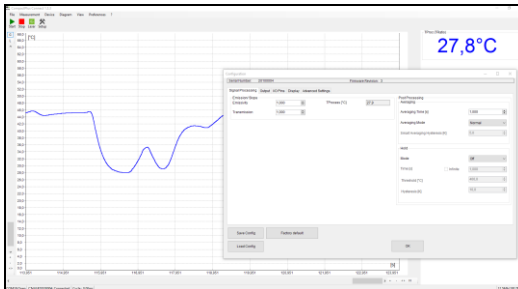

CompactPlus Connect

Main Features:

- Graphic display for temperature trends and automatic data logging for analysis and documentation
- Complete sensor setup and remote controlling
- Adjustment of signal processing functions
- Programming of outputs and functional inputs

7.2 Communication settings



For further information see protocol and command description on the software package CompactConnect or CompactPlus Connect in the directory: `\Commands`.

7.2.1 Serial Interface

Baud rate:	9.6...115.2 kBaud (adjustable on the unit or via software) CTlaser 4M: 115,2 or 921,6 kBaud (adjustable on the unit or via software)
Data bits:	8
Parity:	none
Stop bits:	1
Flow control	off

7.2.2 Protocol

All sensors of the CTlaser series are using a binary protocol. Alternatively they can be switched to an ASCII protocol. To get a fast communication the protocol has no additional overhead with CR, LR or ACK bytes.

7.2.3 ASCII-Protocol

To switch to the ASCII protocol, use the following command:

Decimal:	131
HEX:	0x83
Data, Answer:	byte 1
Result:	0 – Binary protocol 1 – ASCII protocol

7.2.4 Save parameter settings

After switch-on of the CTlaser sensor the flash mode is active. This means, changed parameter settings will be saved in the internal Flash-EEPROM and will be kept also after the sensor is switched off. If the settings need to change continuously the flash mode can be switched off by using the following command:

Decimal:	112
HEX:	0x70
Data, Answer:	byte 1
Result:	0 – Data will be written into the flash memory 1 – Data will not be written into the flash memory

If the flash mode is off, all settings only will be kept as long as the unit is powered. This means that all previous settings are getting lost if the unit is switched off and powered on again. The command 0x71 will poll the current state.

8 Basics of Infrared Thermometry

Depending on the temperature each object emits a certain amount of infrared radiation. A change in the temperature of the object is accompanied by a change in the intensity of the radiation. For the measurement of “thermal radiation” infrared thermometry uses a wave-length ranging between 1 μm and 20 μm . The intensity of the emitted radiation depends on the material. This material contingent constant is described with the help of the emissivity which is a known value for most materials (► **9 Emissivity**).

Infrared thermometers are optoelectronic sensors. They calculate the surface temperature on the basis of the emitted infrared radiation from an object. The most important feature of infrared thermometers is that they enable the user to measure objects contactless. Consequently, these products help to measure the temperature of inaccessible or moving objects without difficulties. Infrared thermometers basically consist of the following components:

- lens
- spectral filter
- detector
- electronics (amplifier/ linearization/ signal processing)

The specifications of the lens decisively determine the optical path of the infrared thermometer, which is characterized by the ratio Distance to Spot size. The spectral filter selects the wavelength range, which is relevant for the temperature measurement. The detector in cooperation with the processing electronics transforms the emitted infrared radiation into electrical signals.

9 Emissivity

9.1 Definition

The intensity of infrared radiation, which is emitted by each body, depends on the temperature as well as on the radiation features of the surface material of the measuring object. The emissivity (ϵ – Epsilon) is used as a material constant factor to describe the ability of the body to emit infrared energy. It can range between 0 and 100 %. A “blackbody” is the ideal radiation source with an emissivity of 1.0 whereas a mirror shows an emissivity of 0.1.

If the emissivity chosen is too high, the infrared thermometer may display a temperature value which is much lower than the real temperature – assuming the measuring object is warmer than its surroundings. A low emissivity (reflective surfaces) carries the risk of inaccurate measuring results by interfering infrared radiation emitted by background objects (flames, heating systems, chamottes). To minimize measuring errors in such cases, the handling should be performed very carefully and the unit should be protected against reflecting radiation sources.

9.2 Determination of unknown emissivity

- ▶ First determine the actual temperature of the measuring object with a thermocouple or contact sensor. Second, measure the temperature with the infrared thermometer and modify the emissivity until the displayed result corresponds to the actual temperature.
- ▶ If you monitor temperatures of up to 380 °C you may place a special plastic sticker (emissivity dots – **Order No.: ACLSED**) onto the measuring object, which covers it completely. Set the emissivity to 0.95 and take the temperature of the sticker. Afterwards, determine the temperature of the adjacent area on the measuring object and adjust the emissivity according to the value of the temperature of the sticker.
- ▶ Cover a part of the surface of the measuring object with a black, flat paint with an emissivity of 0,98. Adjust the emissivity of your infrared thermometer to 0,98 and take the temperature of the colored surface. Afterwards, determine the temperature of a directly adjacent area and modify the emissivity until the measured value corresponds to the temperature of the colored surface.

CAUTION: On all three methods the object temperature must be different from ambient temperature.

9.3 Characteristic emissivity

In case none of the methods mentioned above help to determine the emissivity you may use the emissivity table ► **Appendix A** and **Appendix B**. These are average values only. The actual emissivity of a material depends on the following factors:

- temperature
- measuring angle
- geometry of the surface
- thickness of the material
- constitution of the surface (polished, oxidized, rough, sandblast)
- spectral range of the measurement
- transmissivity (e.g. with thin films)

Appendix A – Table of emissivity for metals

Material		typical Emissivity			
		1,0 μm	1,6 μm	5,1 μm	8-14 μm
Aluminium	non oxidized	0,1-0,2	0,02-0,2	0,02-0,2	0,02-0,1
	polished	0,1-0,2	0,02-0,1	0,02-0,1	0,02-0,1
	roughened	0,2-0,8	0,2-0,6	0,1-0,4	0,1-0,3
	oxidized	0,4	0,4	0,2-0,4	0,2-0,4
Brass	polished	0,35	0,01-0,05	0,01-0,05	0,01-0,05
	roughened	0,65	0,4	0,3	0,3
	oxidized	0,6	0,6	0,5	0,5
Copper	polished	0,05	0,03	0,03	0,03
	roughened	0,05-0,2	0,05-0,2	0,05-0,15	0,05-0,1
	oxidized	0,2-0,8	0,2-0,9	0,5-0,8	0,4-0,8
Chrome		0,4	0,4	0,03-0,3	0,02-0,2
Gold		0,3	0,01-0,1	0,01-0,1	0,01-0,1
Haynes	alloy	0,5-0,9	0,6-0,9	0,3-0,8	0,3-0,8
Inconel	electro polished	0,2-0,5	0,25	0,15	0,15
	sandblast	0,3-0,4	0,3-0,6	0,3-0,6	0,3-0,6
	oxidized	0,4-0,9	0,6-0,9	0,6-0,9	0,7-0,95
Iron	non oxidized	0,35	0,1-0,3	0,05-0,25	0,05-0,2
	rusted		0,6-0,9	0,5-0,8	0,5-0,7
	oxidized	0,7-0,9	0,5-0,9	0,6-0,9	0,5-0,9
	forged, blunt	0,9	0,9	0,9	0,9
	molten	0,35	0,4-0,6		
Iron, casted	non oxidized	0,35	0,3	0,25	0,2
	oxidized	0,9	0,7-0,9	0,65-0,95	0,6-0,95

Material		typical Emissivity			
		1,0 μm	1,6 μm	5,1 μm	8-14 μm
Lead	polished	0,35	0,05-0,2	0,05-0,2	0,05-0,1
	roughened	0,65	0,6	0,4	0,4
	oxidized		0,3-0,7	0,2-0,7	0,2-0,6
Magnesium		0,3-0,8	0,05-0,3	0,03-0,15	0,02-0,1
Mercury			0,05-0,15	0,05-0,15	0,05-0,15
Molybdenum	non oxidized	0,25-0,35	0,1-0,3	0,1-0,15	0,1
	oxidized	0,5-0,9	0,4-0,9	0,3-0,7	0,2-0,6
Monel (Ni-Cu)		0,3	0,2-0,6	0,1-0,5	0,1-0,14
Nickel	electrolytic	0,2-0,4	0,1-0,3	0,1-0,15	0,05-0,15
	oxidized	0,8-0,9	0,4-0,7	0,3-0,6	0,2-0,5
Platinum	black		0,95	0,9	0,9
Silver		0,04	0,02	0,02	0,02
Steel	polished plate	0,35	0,25	0,1	0,1
	rustless	0,35	0,2-0,9	0,15-0,8	0,1-0,8
	heavy plate			0,5-0,7	0,4-0,6
	cold-rolled	0,8-0,9	0,8-0,9	0,8-0,9	0,7-0,9
	oxidized	0,8-0,9	0,8-0,9	0,7-0,9	0,7-0,9
Tin	non oxidized	0,25	0,1-0,3	0,05	0,05
Titanium	polished	0,5-0,75	0,3-0,5	0,1-0,3	0,05-0,2
	oxidized		0,6-0,8	0,5-0,7	0,5-0,6
Wolfram	polished	0,35-0,4	0,1-0,3	0,05-0,25	0,03-0,1
Zinc	polished	0,5	0,05	0,03	0,02
	oxidized	0,6	0,15	0,1	0,1

Appendix B – Table of emissivity for non-metals

Material	typical Emissivity			
	1,0 μm	2,2 μm	5,1 μm	8-14 μm
Asbestos	0,9	0,8	0,9	0,95
Asphalt			0,95	0,95
Basalt			0,7	0,7
Carbon non oxidized		0,8-0,9	0,8-0,9	0,8-0,9
graphite		0,8-0,9	0,7-0,9	0,7-0,8
Carborundum		0,95	0,9	0,9
Ceramic	0,4	0,8-0,95	0,8-0,95	0,95
Concrete	0,65	0,9	0,9	0,95
Glass plate		0,2	0,98	0,85
melt		0,4-0,9	0,9	
Grit			0,95	0,95
Gypsum			0,4-0,97	0,8-0,95
Ice				0,98
Limestone			0,4-0,98	0,98
Paint non alkaline				0,9-0,95
Paper any color			0,95	0,95
Plastic >50 μm non transparent			0,95	0,95
Rubber			0,9	0,95
Sand			0,9	0,9
Snow				0,9
Soil				0,9-0,98
Textiles			0,95	0,95
Water				0,93
Wood natural			0,9-0,95	0,9-0,95

Appendix C – Smart Averaging

The average function is generally used to smoothen the output signal. With the adjustable parameter time this function can be optimal adjusted to the respective application. One disadvantage of the average function is that fast temperature peaks which are caused by dynamic events are subjected to the same averaging time. Therefore those peaks can only be seen with a delay on the signal output.

The function **Smart Averaging** eliminates this disadvantage by passing those fast events without averaging directly through to the signal output.

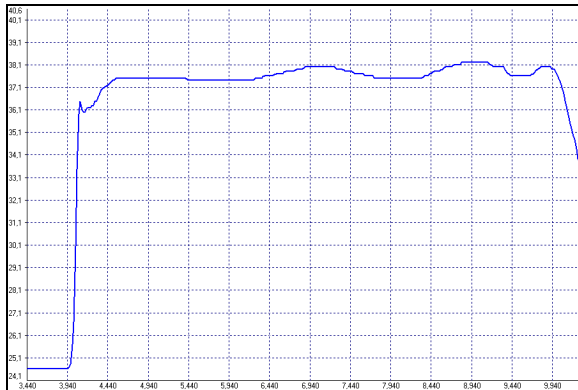

Signal graph with **Smart Averaging** function

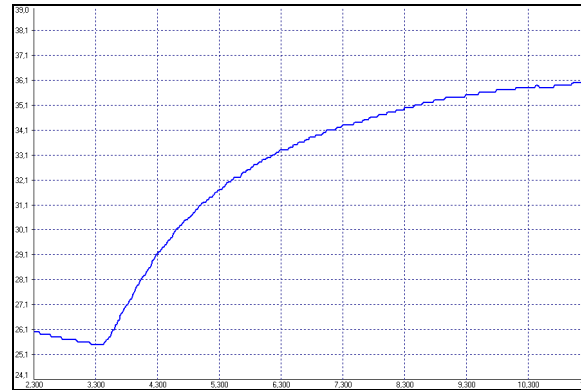

Signal graph without **Smart Averaging** function

Appendix D – Declaration of Conformity

EG-Konformitätserklärung EU Declaration of Conformity



Wir / We

Optris GmbH
Ferdinand Buisson Str. 14
D-13127 Berlin

erklären in alleiniger Verantwortung, dass
declare on our own responsibility that

die Produktserie **optris CTLaser**
the product group **optris CTLaser**

den Anforderungen der EMV-Richtlinie **2014/30/EU** und der allgemeinen Produktsicherheitsrichtlinie **2007/95/EG** entspricht.
meets the provisions of the EMC Directive **2014/30/EU** and the General Product Safety Directive **2007/95/EC**.

Angewandte harmonisierte Normen:
Applied harmonized standards:

EMV Anforderungen / EMC General Requirements:
EN 61326-1:2013 (Grundlegende Prüfanforderungen / Basic requirements)
EN 61326-2-3:2013

Gerätesicherheit von Messgeräten / Safety of measurement devices:

EN 61010-1:2010
EN 60825-1:2014 (Lasersicherheit / Laser safety)

Dieses Produkt erfüllt die Vorschriften der Richtlinie **2015/863/EU** (RoHS) des Europäischen Parlaments und des Rates vom 4. Juni 2015 zur Beschränkung der Verwendung bestimmter gefährlicher Stoffe in Elektro- und Elektronikgeräten.
This product is in conformity with Directive **2015/863/EU** (RoHS) of the European Parliament and of the Council of 4 June 2015 on the restriction of the use of certain hazardous substances in electrical and electronic equipment.

Berlin, 16.03.2021

Ort, Datum / place, date

Dr. Ulrich Klenitz
Geschäftsführer / General Manager

optris CTlaser – E2021-04-A