

optris PIX Connect

Software for Thermal Imager

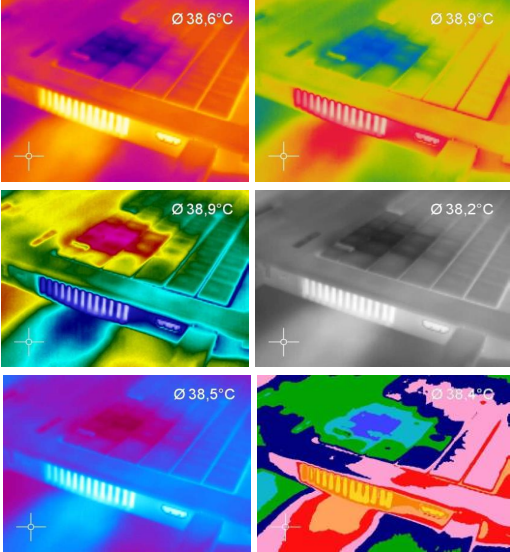

Operator's Manual

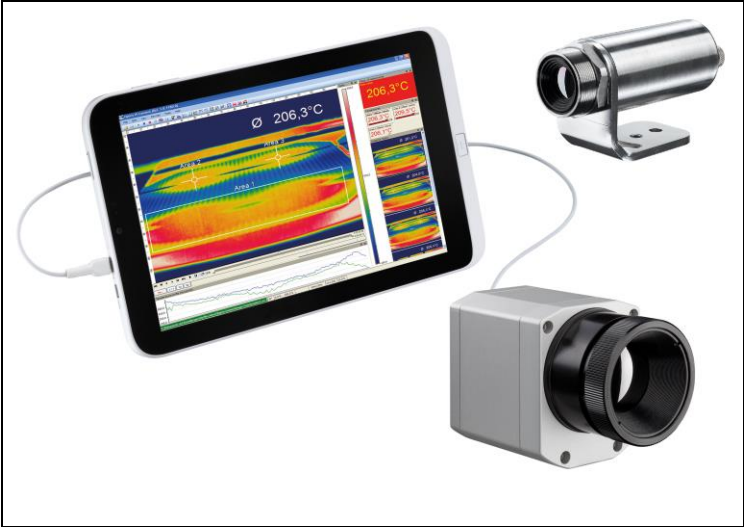

Content

Content	2	2.3.1. Mirroring of displayed image.....	31
Welcome!	5	2.3.2. Rotation of displayed image.....	31
Legal disclaimer	6	2.3.3. Zooming in areas of the displayed image.....	32
1. Getting started.....	7	2.4. Imager configuration.....	33
1.1. Software installation.....	7	2.4.1. Calibration files.....	33
1.2. Choice of camera	9	2.4.2. Correction of camera calibration	33
1.3. Choice of language.....	9	2.4.3. Detector heating (Chip temperature mode).....	34
1.4. Software window (example).....	10	2.4.4. Emissivity, transmissivity, ambient temperature..	35
1.5. Menu and Toolbar (Icons).....	14	35
1.5.1. Menu.....	14	2.4.5. Reference temperature.....	36
1.5.2. Toolbar (Icons).....	15	2.4.6. Changing the optics (only PI).....	38
2. Software configuration	17	2.4.7. Changing the temperature range	39
2.1. General settings	17	2.4.8. Video formats (Device framerate)	40
2.1.1. Color palettes.....	17	2.5. Imager interfaces for PI and Xi 400 camera.....	41
2.1.2. Temperature unit.....	19	2.5.1. General	41
2.1.3. Temperature range scaling of reference bar...	19	2.5.2. Process interface (PIF)	42
2.1.4. Displayed frame rate.....	21	2.6. Software Development Kit (SDK)	46
2.1.5. Change of title bar.....	22	2.6.1. Interprocess Communication (IPC)	46
2.1.6. Optimization of software.....	22	2.6.2. COM-Port.....	47
2.1.7. Lock / unlock application	23	2.6.3. Web Server	48
2.2. Software layout.....	24	2.6.4. Direct temperature mode (only for Xi 80 and Xi	49
2.2.1. Displayed windows	24	410).....	49
2.2.2. View bars.....	25	2.7. Start options.....	50
2.2.3. Information within image	25	2.7.1. Overview of start options	50
2.2.4. Temperatures in digital displays	26	2.7.2. Start of multiple software / imager instances...	52
2.2.5. Layout management	27	3. Data capturing	54
2.2.6. Assign / remove layouts	28	3.1. Open files.....	54
2.2.7. Import/Export layouts	28	3.2. Replay of files	54
2.2.8. Further information.....	30	3.2.1. Control panel.....	54
2.3. Arranging of thermal image.....	31	3.2.2. Replay options.....	55
		3.3. Editing video sequences	56
		3.4. Saving files.....	57
		3.4.1. Setting the recording frame rate	57

3.4.2.	Setting the recording modes	58	5.2.	Imager interfaces for Xi 80/410.....	102
3.4.3.	Temporary recording file	60	5.2.1.	General	103
3.4.4.	Saving radiometric video sequences	61	5.2.2.	Process interface (PIF)	104
3.4.5.	Saving image data as radiometric snapshot or text file	62	5.3.	Ethernet Xi 80/410	108
3.4.6.	Saving text file of the temperature / time diagram	66	5.3.1.	Ethernet setup (Point-to-Point-Connection)...	108
3.4.7.	Location and filename templates of triggered recordings	66	5.4.	Autonomous operation Xi 80/410	112
3.4.8.	Display of snapshots in a separate window	67	6.	Line scanner mode	116
3.4.9.	Saving images or screenshots to clipboard	69	6.1.	General information	116
3.4.10.	Capture Screen.....	70	6.2.	Basic settings	117
4.	Data processing	72	6.2.1.	Line scanner configuration menu	117
4.1.	Measure areas.....	72	6.2.2.	Choosing the layout.....	117
4.1.1.	General settings.....	72	6.2.3.	Rotating of the image	117
4.1.2.	Calculated Objects	78	6.2.4.	Activating the Line scanner.....	118
4.1.3.	Including and excluding hot and cold spot areas	81	6.2.5.	Positioning of the line (Line scanner sighting view).....	118
4.1.4.	Individual emissivity values of measure areas	83	6.2.6.	Layout configuration of the Sighting view mode	122
4.2.	Temperature profile	84	6.3.	Data evaluation of the scanned line	123
4.3.	Temperature Time Diagram	87	6.3.1.	Line scanner view	123
4.3.1.	General settings	87	6.3.2.	Triggered display of lines.....	126
4.3.2.	Scaling of diagram axes	89	6.3.3.	Snapshot configuration	129
4.4.	Histogram	90	6.3.4.	Zoom function of snapshots.....	130
4.5.	Extended measuring colors	93	7.	Merging	131
4.6.	Image subtraction	94	7.1.	General Information.....	131
4.7.	Relative extreme values.....	95	7.2.	Direct Connection over USB Port	133
4.8.	Alarms	96	7.2.1.	Configuration	133
4.9.	3D display of thermal image.....	98	7.3.	Connection via the Ethernet network	140
4.10.	Event grabber	99	7.4.	Merging with the use of the PIF	141
4.11.	Zoom function of snapshots	101	7.5.	Simultaneous flag control	142
5.	Xi camera.....	102	7.6.	Simultaneous frame synchronization via PIF	143
5.1.	Focus setting	102	8.	Further information	145
			8.1.	Options	145
			8.1.1.	Activating software messages	145

8.1.2. Layouts	146
8.1.3. Temperature unit.....	146
8.1.4. Log events	147
8.2. System requirements.....	148
8.3. About software.....	148
8.4. Extended Configuration	149
8.5. Overview shortcuts	150

Welcome!

Thank you for choosing the optris PI and/or Xi infrared camera and corresponding PIX Connect software!

The optris PI or Xi calculates the surface temperature based on the emitted infrared energy of objects [► **Basics of Infrared Thermometry**]. The two-dimensional detector (FPA - Focal Plane Array) or (CMOS - Complementary metal-oxide-semiconductor) allows a measurement depending on the device max. pixels and will be shown as thermographic image using standardized palettes. The radiometric processing of the picture data enables the user to do a comfortable detailed analysis using the software PIX Connect.

Main features of PIX Connect software:

- Display of the real time thermal image (up to a max. of 1 kHz) with a wide range of measurement functions
- Recording function (video, radiometric video, snapshot)
- Analysis and post processing of infrared images/ videos
- Complete set up of parameters and remote control of the camera

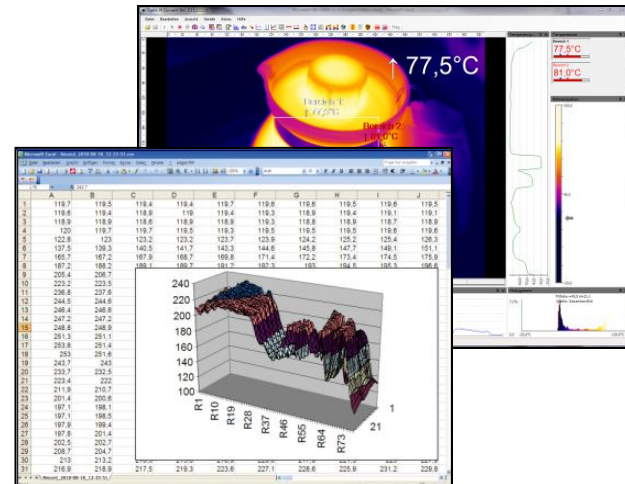

Legal disclaimer

All products are warranted against defective materials and workmanship for a period of two (2) years from the delivery date of the original purchase, provided such products have been under normal storage, use and service, and in accordance with the instruction. This warranty expires in case of inappropriate use of all delivered components.

All products not manufactured by us included in systems delivered by us to the original purchaser carry the warranty, if any, of the particular supplier only and we have no responsibility whatsoever for such products. The manufacturer is not liable for any use of the software PIX Connect including data recording. The manufacturer does not carry liability for error-free operation of the software in any hardware and operating system.

The warranty is not expressed for possible quality changes, errors when presenting the software, occurring defects during operation or insufficiencies in certain applications. The user is liable for any defects or data processing insufficiencies when in using the software.

The manufacturer has no other liability inside the scope of supply other than mentioned above. The manufacturer shall not be liable for any business loss or claim for compensation, loss of the computer software, possible loss of data, additional costs for replacement software, claims of third parties or other occurring costs or failures and deficits.

The software is protected by copyright and is not allowed to be changed or sold to third parties.

Optris GmbH
Ferdinand-Buisson-Str. 14
13127 Berlin
Germany

Phone: +49-30-500 197-0
Fax: +49-30-500 197-10

E-mail: info@optris.global
Internet: www.optris.global



Note

Read the manual carefully before you start the device. The manufacturer reserves the right to change the herein described specifications in case of technical advance of the product.

1. Getting started

1.1. Software installation

Please install at first the software PIX Connect which is included on the USB stick. The stick contains the software application, the specific calibration data of the imager as well as some sample files. These data will be installed automatically.



Note

Alternatively, the software can also be downloaded via the Optris website under the following link:
<https://www.optris.global/pix>

Please start the **setup.exe** from the USB stick. Follow the instructions of the wizard until the installation is finished.

At the end of the installation, you will get an overview of what has been added, changed and corrected in the current software version. You will find this overview again on the data medium under the document name **Changelog**.

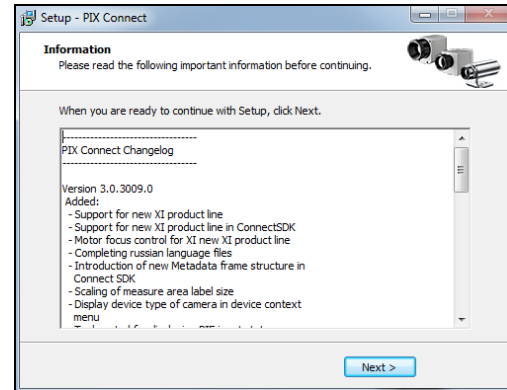

The installation wizard will place a launch icon on the desktop and in the start menu.

Now you can connect the infrared imager into an USB port (USB 2.0 or higher) of your PC. After the software has been started, you should see the live image from the camera inside a window on your PC screen.

The sharpness of the image can be adjusted by turning the exterior lens ring at the camera (PI) or by using the distance function in the software (Xi).

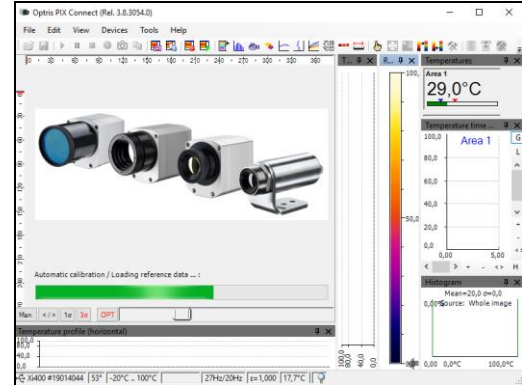

Note



- For installation please be logged in as admin in Windows. When starting the PIX Connect software you should also have admin rights.
 - Using Windows 10: Go to Windows Settings, click Privacy, and under App Permissions, click on Camera. Activate "Allow apps to access your camera". Restart PIX Connect and also reconnect the camera.
 - Further actions: Deactivation of firewall and/or virus scanner (especially Kaspersky!). Firmware upgrade in PIX Connect (Tools/Extended/Firmware update). Reload calibration data (Tools/Extended/Load calibration data/From Internet)
-

1.2. Choice of camera

In case you are using more than one camera simultaneously (e.g. via USB hub) please select the required device from the list in the **Devices** menu.

1.3. Choice of language

In the **Tools** and **Language** menu you can choose from a variety of available languages.



Note

In case your language is not provided you will find a translation tool on the USB stick delivered with the camera.

1.4. Software window (example)

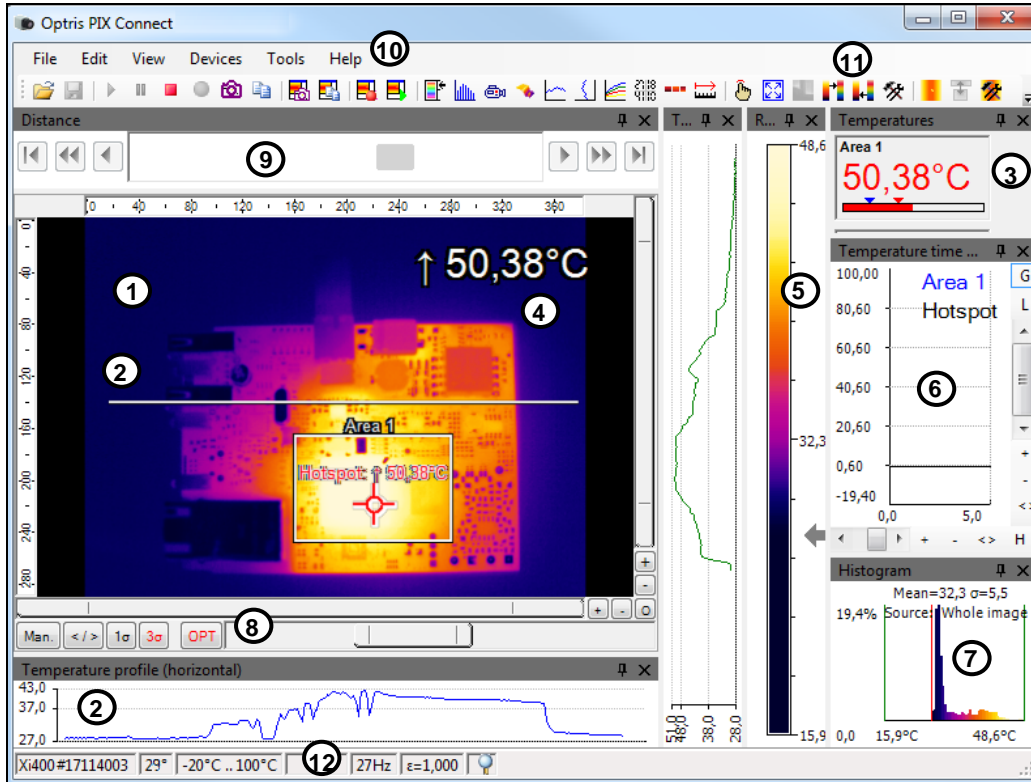

- 1 IR image from the camera
- 2 Temperature profile: Shows the temperatures along max. 2 lines at any size and position in the image.

Control displays: Displays all temperature values in the defined measure areas like Cold Spots, Hot Spots, temperature at cursor, internal temperature and chip temperature.
- 3 Alarm settings: Bar showing the defined temperature thresholds for low alarm value (blue arrow) and high alarm value (red arrow). The color of numbers within control displays changes to red (when temp. above the high alarm value) and to blue (when temp. below the low alarm value).
- 4 Temperature of measure area: Analyses the temperature according to the selected shape, e.g. average temperature of the rectangle. The value is shown inside the IR image and the control displays.
- 5 Reference bar: Shows the scaling of temperature within the color palette.
- 6 Temperature time diagram: Shows the temperature curves over time for selectable region of interest (ROI)
- 7 Histogram: Shows the statistic distribution of single temperature values.
- 8 Automatic / manual scaling of the palette (displayed temperature range): Man., σ (min, max), 1σ : 1 Sigma, 3σ : 3 Sigma, OPT: Palette optimization
- 9 Distance function: Adjustment of the motor focus to focus the IR picture
- 10 Menu and Toolbar (Icons)
- 11 Icon enabling switching between color palettes
- 12 Status bar: Model and serial number, optic, temperature range, cursor position, device framerate/ display framerate, emissivity, ambient temperature, flag status

Under **View** and **User Mode** you can select between two additional display options. In addition to the **Desktop** view, the **Touch** view or the **Tablet** view can also be used here. These additional views are particularly useful when using a touch computer or a tablet. The screen and menu are customized and displayed according to their functions.

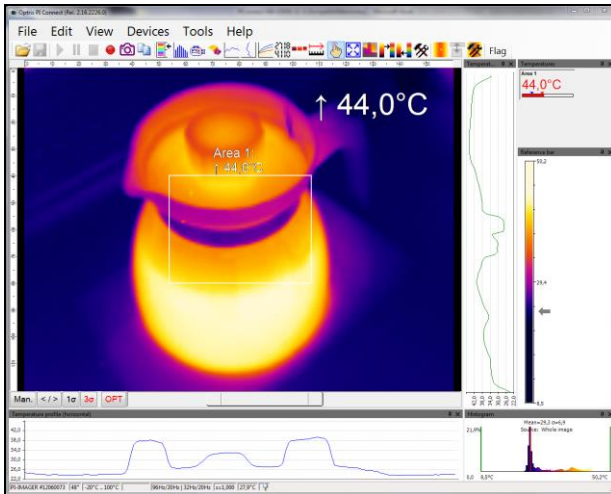
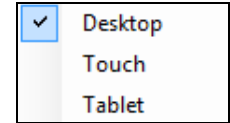

User Mode Touch

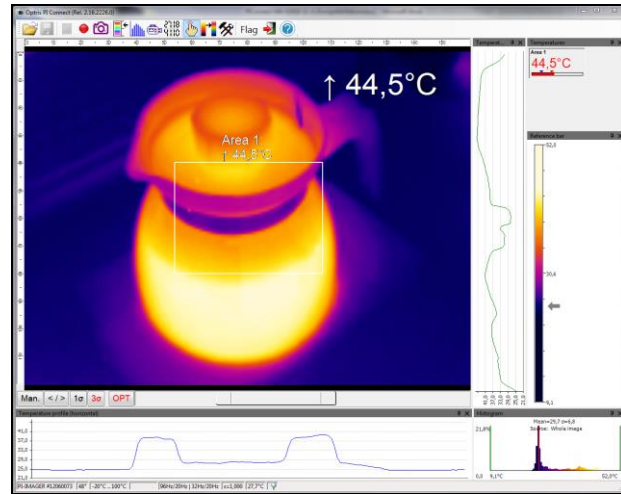

User Mode Tablet

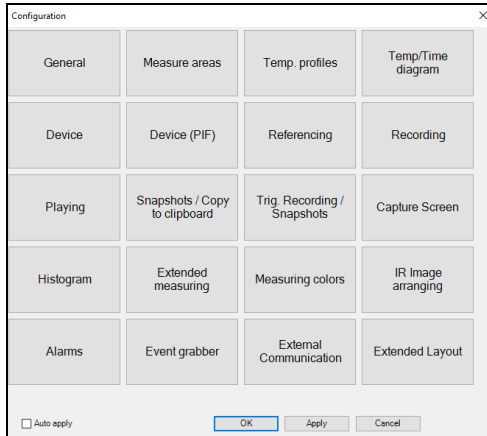

Configuration window for User Mode Touch and Tablet



Note

The User Mode **Tablet** provides only limited functionality.

1.5. Menu and Toolbar (Icons)

1.5.1. Menu













Using the menu you can adjust all software settings. Each feature will be explained in detail in the following chapters of this manual:













File Edit View Devices Tools Help













File	Open, save and replay of files; recording; saving temp./time diagram data; snapshot; screenshot; capture screen
Edit	Editing of sequences and layouts
View	Display or fade-out of different software features
Devices	Choice of camera and self-referencing
Tools	Additional settings of camera and software parameters as line scanner mode; layouts; language; extended settings as merged device configuration and updating the firmware
Help	Information about software; documentation; SDK; locking application



1.5.2. Toolbar (Icons)



The most important features of the software can be activated directly via the toolbar. You can redesign the toolbar according to your preferences (see section 2.2.2). Available toolbar icons are the following:



	Open
	Save
	Play
	Pause
	Stop
	Record
	Save snapshot to file
	Copy snapshot to clipboard
	Save screenshot to file
	Screenshot to clipboard
	Capture screen
	Replay captured screen

	Histogram
	Visible Video
	3D Chart
	Temperature profile (horizontal)
	Temperature profile (vertical)
	Temperature time diagram
	Digital display group
	Snapshot history
	Distance
	Toggle user mode
	Full screen
	IR/Visible Fusion

	Previous palette
	Configuration
	Enable linescanning
	Linescanner view ↔ Sighting view
	Linescanner configuration
	Image subtraction
	Image subtraction from file
	Refresh Flag
	Acknowledge Alarm
	Close all tools
	Digital display (main measure area)
	Digital display (mouse cursor)

	Reference bar
	Toggle Minimum, Mean Value, Maximum

	Next palette
	Config merged device

	Exit
	About

2. Software configuration

2.1. General settings

You can activate all here mentioned features in the **Tools**, **Configuration** and **General** menu (except for color palettes and temperature unit).

2.1.1. Color palettes

In the **Tools**, **Configuration**, **Measuring colors** and **Standard palette** menu you can choose from a list of color palettes to achieve ideal displaying of the infrared image and the included temperature information.

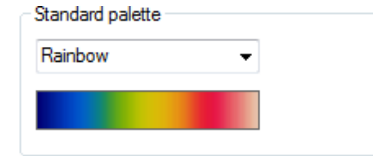

You can also adjust the color palette via the **Icon** on the toolbar or the menu **View** and **Shift palette**.

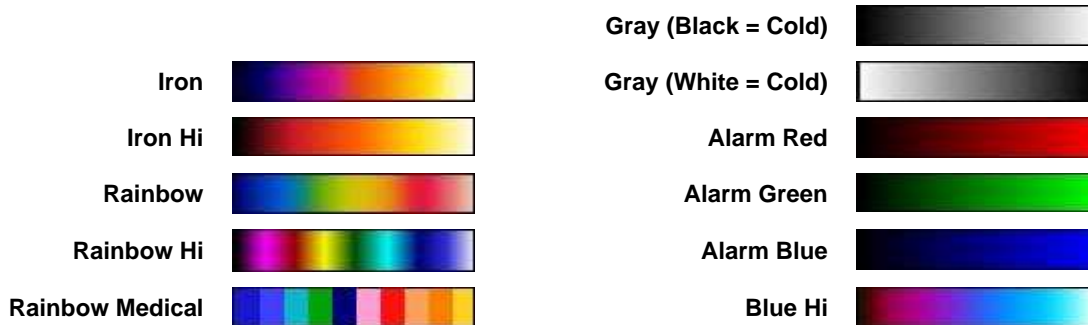

Examples of various color palettes:



Palette Iron

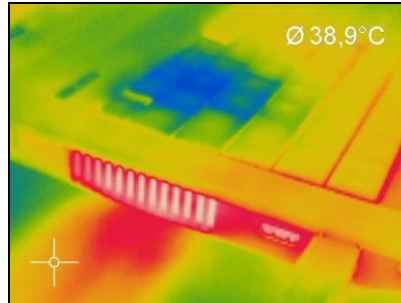

Palette Rainbow

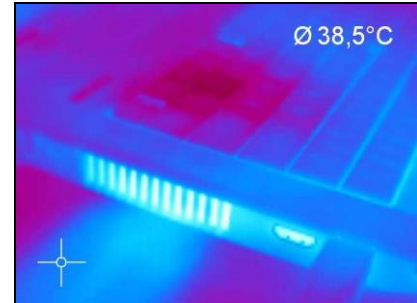

Palette Blue Hi

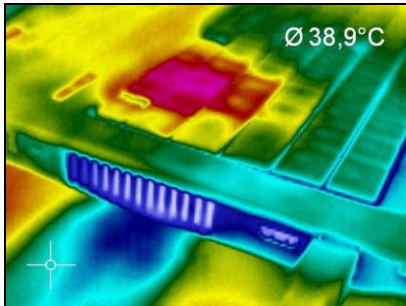

Palette Rainbow Hi

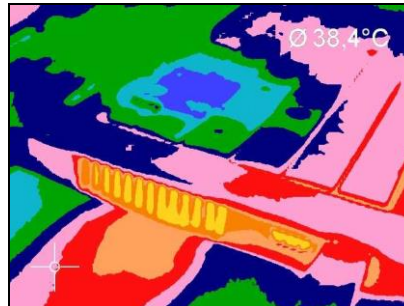

Palette Rainbow Medical

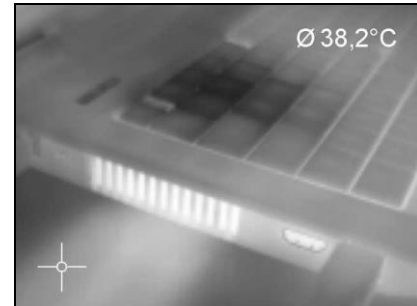

Palette Gray (Black = Cold)

2.1.2. Temperature unit

The temperature unit can be changed in the menu **Tools**, **Extended** and **Options**. When setting the **Temperature unit** you can choose between **Celsius (°C)** and **Fahrenheit (°F)**.

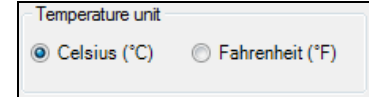

Alternatively, the temperature unit can also be changed by pressing the right mouse button in the live IR image.

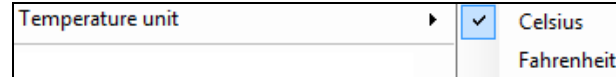

2.1.3. Temperature range scaling of reference bar

Via the **Temperature range scaling** settings you can allocate colors to temperature values within the reference bar.

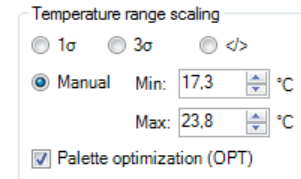

These are the following options:

Manual	The lower and the upper border (Min/Max) can be determined individually.
</>	The software continuously defines the upper and the lower border based on the hottest and coldest pixel in the image.

1 σ	The mean value of all pixels in the image will be continuously calculated. Based on the mean value one standard deviation (1 sigma) sets the limits of reference bar.
3 σ	The mean value of all pixels in the image will be continuously calculated. Based on the mean value three standard deviations (3 sigma) set the limits of reference bar.
OPT	With OPT a contrast optimization is achieved. This function allows an optimum contrast between very low and very high temperatures.

**Note**

Palette optimization (OPT) is not available for PI 1M/ 08M/ 05M.

2.1.4. Displayed frame rate

The option **Reduce displayed frames** defines what frame rate is used to display the image. Typically, the specification is in Hertz (Hz, images per second). The maximum frame rate of the imager depends on the camera model you're using. It is recommended to use the default parameters of 20 Hz.

The camera supplies the software with all images at the whole time. When you using a lower display framerate you have to decide what should happen with the rest of the pictures. Under **Mode** you have several options:

Reduce displayed frames:

Mode: Average ▾

Display framerate: 20 ▾ Hz

Averaging time: 50 ▾ % of frame time

Keep device framerate for temp/time diagram, external communication and PIF outputs

Off	The display frame rate corresponds to the device frame rate of the camera.
Skipping	It skips so many pictures that the set display frame rate results.
Average	The pixels are averaged out of a sequence of images. This weakens the detector noise.
Minimum	From a sequence of images, the smallest value is displayed for each pixel.
Maximum	From a sequence of images, the highest value is displayed for each pixel.
Ext. Averaging	Is a combination of average and skipping and is used at very low display rates. The averaging time indicates how many percent of the set frame time should be averaged. In the remaining time, the frames are skipped (e.g., if the display frequency is 1 Hz and the averaging time is 10%, then 100 ms is averaged and 900 ms are skipped).



Note

A reduced frame rate means a less loaded computer in terms of data processing. Therefore, please adjust the displayed frame rate according to your application as well as to the performance of your computer.

2.1.5. Change of title bar

The **Application title bar** option enables the individual setting for an own title name. The setting **Default** displays the standard software name „PIX Connect“. Using the setting **User defined** you can specify an individual name. The option **Instance name** is important if starting several cameras and software on one computer. The option **Revision name** is disabling the display of software version in the title bar.

Application title bar

Default User defined

Instance name

Revision name

2.1.6. Optimization of software

The display of the thermal image in the main window of the software can be adjusted according to the performance of the computer. Choosing the option **Quality** the display will be enlarged to the highest resolution, but requires a higher computing power. Using a slow computer, it is recommended to choose the option **Performance**. If the bar is placed in the middle, you get a compromise between quality and performance.

Optimization

Quality Performance

If **Keep Aspect Ratio** is selected the aspect ratio will be maintained. The option **Prevent screensaver** is suppressing the screensaver functionality of your computer.

Keep Aspect Ratio

Prevent screensaver

2.1.7. Lock / unlock application

The software offers the possibility to block or unlock the application by entering a password. This is possible under menu **Help** and **Lock / unlock application**. Enter a password and repeat it. Then press **Lock** and the application is locked.

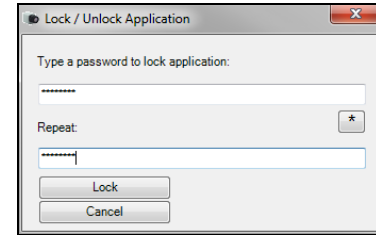

The setting options are now all gray in color and they are no longer able to make changes. Only when you go to **Help** and **Lock / unlock application**, enter the password and click **Unlock**, the software will be unlocked again.

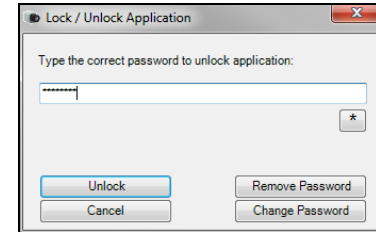

Remove Password removes the current password and with **Change Password** a new password can be assigned.

If the application should be locked again, the current password remains memorized and a repeated entry of the password is no longer necessary.

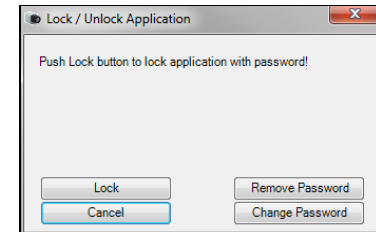

2.2. Software layout

2.2.1. Displayed windows

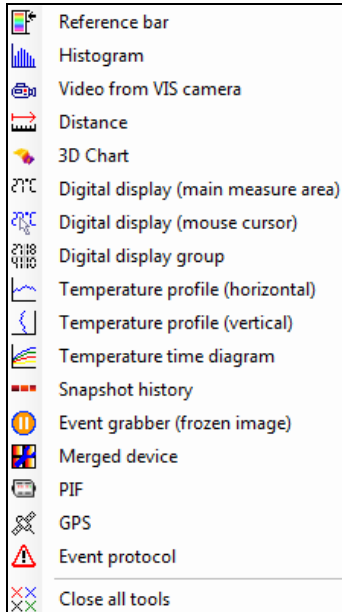

You can individually choose the displayed windows and easily change their positions within the desktop area (drag & drop). To add windows please use the menu item **View** and **Windows**.

On the one hand a window can be positioned separately on the screen. On the other hand a window can be set at a fixed position in the software. The location can be determined using the positioning field (mouse over the arrows „above“, „below“, „right“, „left“).

When a window is dragged into another one (mouse has to be placed within title head) both will be merged. You can switch between them using the tab provided.

Separate window and window with positioning field to place it into the software individually.

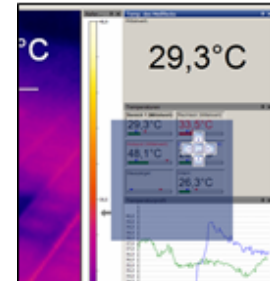
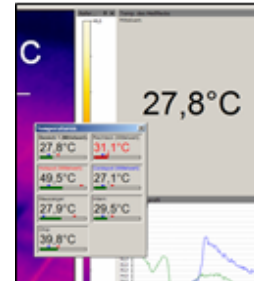

2.2.2. View bars

For individual display of the software, it is possible to show and hide single bars from the software window. In the menu under **View** and **View bars**, in addition to selecting individual functions, it also possible to **Show all bars** or **Hide all bars** with one click.



Note

All icons shown on the toolbar can be individually selected via the option Customize tool bar... (Please see also 1.5.2).

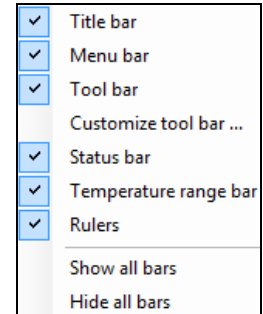

2.2.3. Information within image

Using the menu **View** and **Image Information** you can decide, which information you would like to see inside the infrared image window.

Via **Reference bar** you can set the position of the temperature scale within the infrared image window.

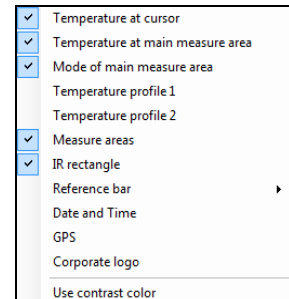

The menu item **Use contrast color** can be used for highlighting particular information within the IR image.

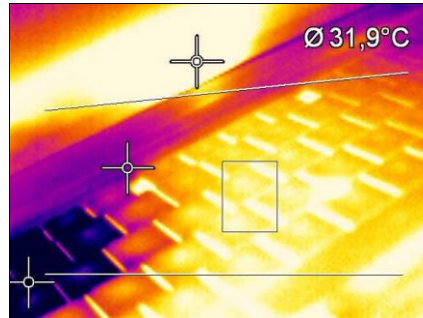
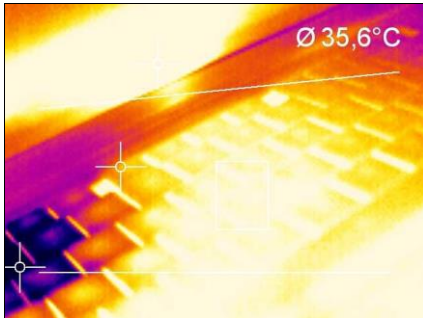

Display of thermal image without and with contrast colors

2.2.4. Temperatures in digital displays

The menu option **View** and **Digital display group temperatures** allows the user to define which temperature control displays will be shown in the application window **Temperatures** (see section 2.2.1).

The shown pre-defined values can also be displayed in the temperature time diagram (see section 4.3). Furthermore, the alarm configuration can be based on these temperatures (see section 4.8)

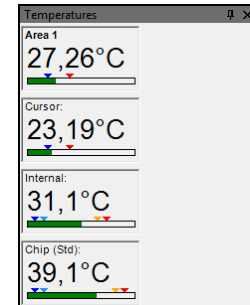
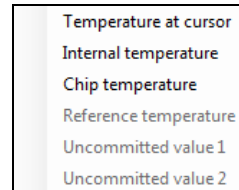

2.2.5. Layout management

In the menu item **Tools** and **Layout** you can manage pre-designed or your own image layouts. If you want to use an alternative layout you must activate it under **Load layout**. You can save your own layouts with user-defined names.



Note

Before you click **Save layout** you must add new layout name into the field provided.

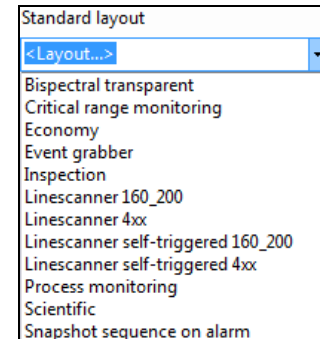
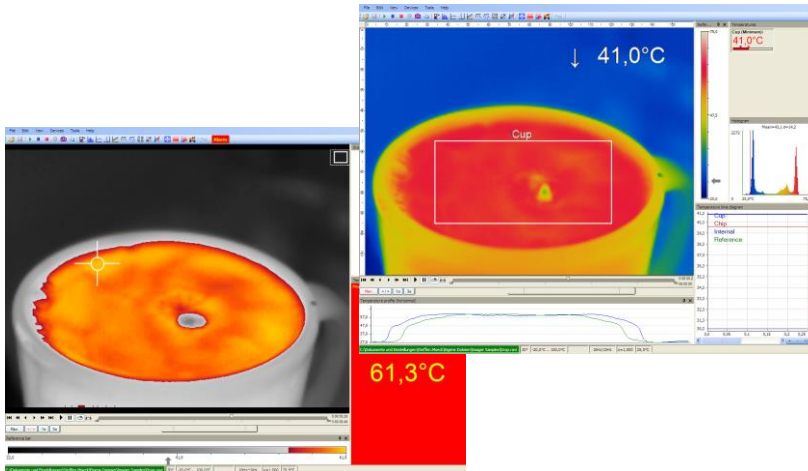
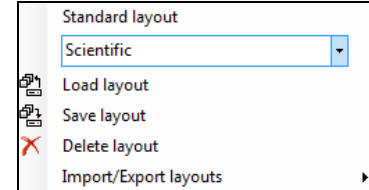

2.2.6. Assign / remove layouts

In the menu item **E**dit and **A**ssign layout to current file you can save files with a new layout setting. Using **R**emove layout from current file it is possible to configure a file in a way that it has no associated layout pattern. When you play it again the layout of the previously played file will be used.



Note

To confirm the changes as explained above you must always save the file. Please use the menu **F**ile and **S**ave or the **i**con on the toolbar.

Under **T**ools, **C**onfiguration and **E**xtended Layout, created layouts can be assigned to specific device types. These layouts are then only visible for the selected device types.

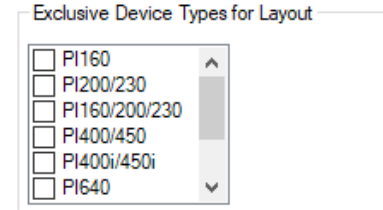

2.2.7. Import/Export layouts

Layouts can be imported and exported in the software. To do this, go to menu **T**ools and **L**ayouts on **I**mport/Export layouts and select the desired function.

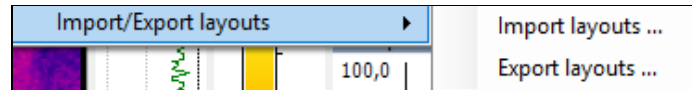

To import layouts, go to **Import layouts...** and select the layout in the directory you want to import into the software. Then press **Import**.

To export layouts, go to **Export layout...** and choose the directory where you want to export the layout. Select the layout you want to export, then choose **Export**.

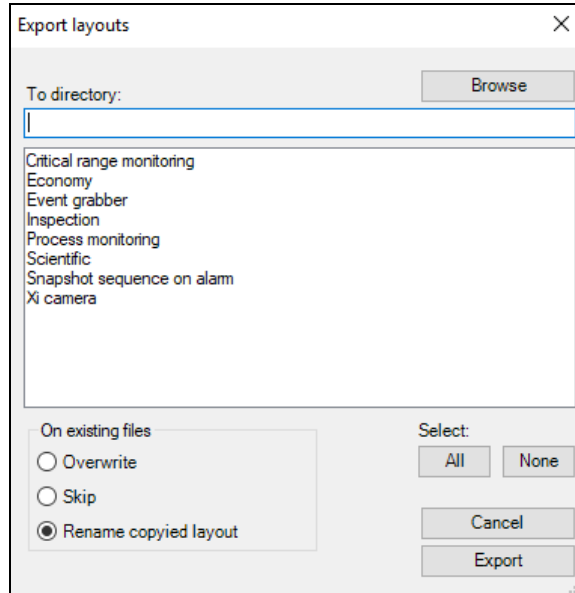
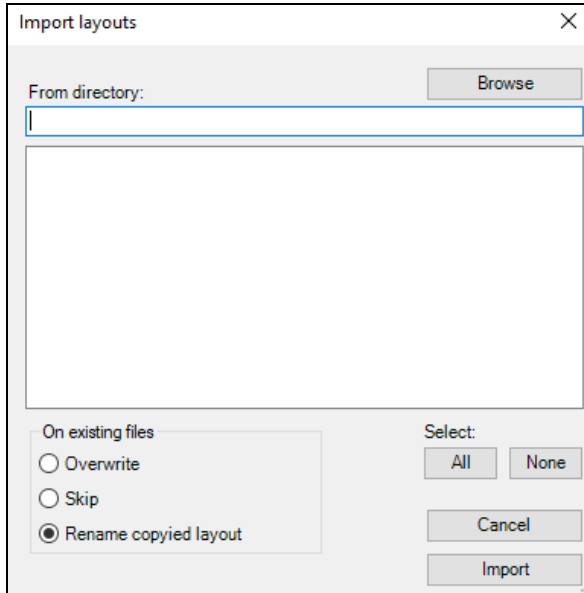

**Note**

Multiple layouts can be imported / exported simultaneously.

2.2.8. Further information

Independent whether other programs are running on your PC the PIX Connect software can always be kept in the foreground. To activate this feature please use **View** and **Always on top**. All other applications will now run in the background.



The thermal image of the main window can be displayed in a full screen mode. Please use the menu **View** and **Full screen** or the **Icon** on the toolbar to change the display size.

Save current configuration

To save current changes in an open software instance, go to **Tools** and **Save current configuration** in the menu or press Ctrl S.

2.3. Arranging of thermal image

The thermal image within the main window of the software can be displayed in various ways using the menu **Tools**, **Configuration** and **IR Image arranging**.

2.3.1. Mirroring of displayed image

Sometimes, depending on the fitting position of the PI, it is useful to **Mirror** the camera image horizontally or vertically. Either the image will be adjusted by the menu mentioned above or under **Tools** and **Mirror**.



2.3.2. Rotation of displayed image

By tagging an icon it is possible to **Rotate** the thermal image into a different position. Alternatively, a manual adjustment can be done by defining a **User defined angle**.

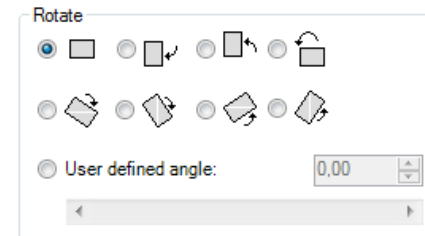

2.3.3. Zooming in areas of the displayed image

Using the **Zoom** option a detail of the image can be enlarged in the main window by the position information. The option can be activated by tagging the **Maximal (diagonal to the square)** field. Furthermore you can use **Pick rectangle for user defined zoom**. The corresponding measuring area can be selected. When **user defined** is selected, the coordinates **Left, Right, Top** and **Bottom** can be entered manually. The **Resulting size** of IR image will be shown below.

Zoom

Off Maximal (diagonal to the square)

Pick rectangle for user defined zoom:

User defined

Left: 40 Right: 120 < ||| >

Top: 30 Bottom: 90 < ||| >

Resulting size: 80 x 60

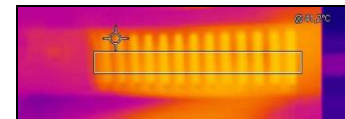
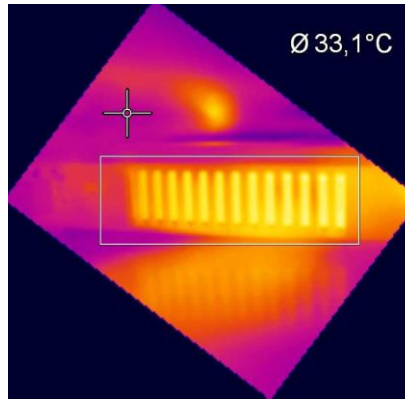
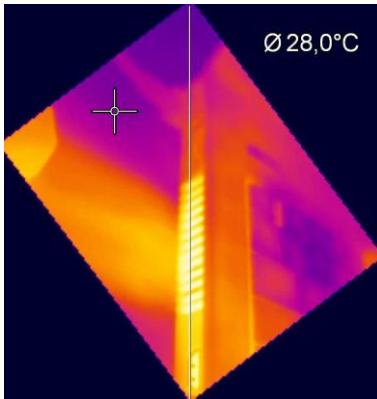

Rotation and zooming of a defined measure area.

2.4. Imager configuration

2.4.1. Calibration files

The menu **Tools**, **Extended** and **Load calibration data** enables to boot the calibration data for the currently connected imager.

2.4.2. Correction of camera calibration

Due to the thermal drift of bolometers all measuring IR cameras need an offset correction every few minutes. This correction is done by a motor driven motion of a blackened metal piece (so called flag) in the front of the image sensor. In this way each image element is referenced with the same temperature. During those offset calibrations thermal cameras do not measure (time is dependent on model and video mode). In order to minimize this disturbing effect the offset correction can be initiated manually or by an external control pin at a suitable point of time.

In the **Devices** and **Refresh flag** menu or via the **Icon** on the toolbar the Flag (Shutter) can be refreshed manually.

The automatic correction of camera can also be set by defining minimum or maximum intervals via the menu **Tools**, **Configuration** and **Device**. The options **Flag automatic** and **Min. Interval** control that the flag will not be released before a given time period even though it might be required by the imager. If the **Max. Interval** is defined the flag will always be released after a certain time period even if not required by the imager. **Force after init.** means that the flag is pulled when the camera is initialized and the temperature range or video format is changed, even if it is controlled externally. The time delay is set to 5 s by default.

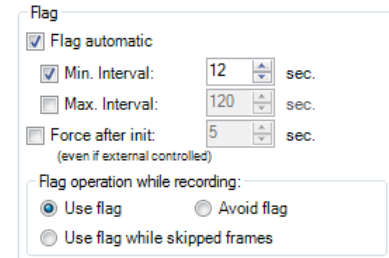

Using the option **Flag operation while recording** and **Use flag** the correction is activated even if the camera is recording. If **Avoid flag** is chosen the camera will not be corrected while recording. The option **Use flag while skipped frames** is suitable at slow data capturing (3 Hz or less) as the correction will take place automatically between two recorded images (correction time app. 250 ms).



Note

The manual or automatic flag functionality is not available if the flag is externally controlled, e.g. via the process interface input (please also see **2.5**).



Note

The flag can be also used to protect the detector from potentially dangerous radiation (for example laser radiation).

2.4.3. Detector heating (Chip temperature mode)

The bolometer chip temperature can be set under **Configuration** and **Device**. **Standard (Floating)** means that the chip heater is off. The chip temperature results from the ambient temperature. With **Automatic**, a predefined temperature is set. And a fixed chip temperature can be set with **Fixed value**.

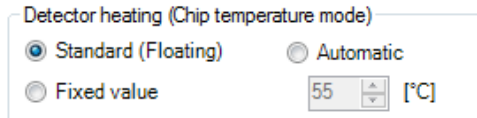

Note

The detector heating (Chip temperature mode) setting is only available for the PI series (except G7 models) because there is no chip heater integrated for the Xi series. For the G7 models of the PI series, the detector heating is automatically on and not adjustable.

2.4.4. Emissivity, transmissivity, ambient temperature

Using the menu **Tools**, **Configuration** and **Device** the **Emissivity** and the **Transmissivity (IR-window compensation)** can be set. The transmissivity is referring to the loss of radiation if an object's surface is measured by looking through a suitable window.

Fixed radiometric values

Emissivity:	1,000
Transmissivity: (IR-window compensation)	1,000
Ambient temperature:	<input checked="" type="checkbox"/> 23,0 [°C]

Knowing the **Ambient temperature** is inevitable for a correct temperature measurement. The ambient temperature value is delivered by the camera's internal sensor by default. Alternatively, the value can be set as a fixed value.

Alternatively, the emissivity can also be changed via the status bar in the PIX Connect software window. To do this, make a right-click on emissivity.

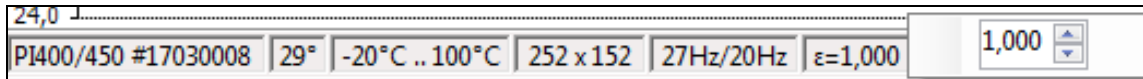

Note



In case that the emissivity and / or the ambient temperature values are controlled through the Process Interface (PIF) the here defined values will be ignored (please also see 2.5). The display of actual values will be shown in the status bar.

2.4.5. Reference temperature

The detector of the thermal imager has a thermal drift over the time and must be corrected by self referencing. At applications where a high measurement accuracy is needed, the thermal image can be corrected permanently by setting a reference temperature. Using the menu **Tools**, **Configuration**, **Device** and **Reference temperature** several options for manual or automatic correction can be set.

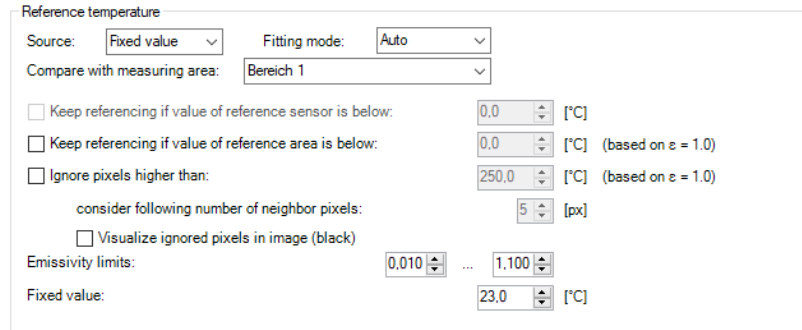

The screenshot shows a configuration window titled "Reference temperature". It contains several settings:

- Source:** Fixed value (dropdown)
- Fitting mode:** Auto (dropdown)
- Compare with measuring area:** Bereich 1 (dropdown)
- Keep referencing if value of reference sensor is below: 0.0 [°C]
- Keep referencing if value of reference area is below: 0.0 [°C] (based on $\epsilon = 1.0$)
- Ignore pixels higher than: 250.0 [°C] (based on $\epsilon = 1.0$)
 - consider following number of neighbor pixels: 5 [px]
 - Visualize ignored pixels in image (black)
- Emissivity limits:** 0,010 ... 1,100
- Fixed value:** 23.0 [°C]

If there is an area within a thermal image having a constant temperature value (e.g. black body) the **Source** can be defined as a **Fixed value**.

When using the **BR 20AR** ambient radiator, the **External probe** option must be selected.

By the option **Compare with measuring area** the area with constant temperatures can be determined. The known reference value can be set within **Fixed value**. If the temperatures are changing slightly within the defined area due to a thermal drift, the whole image will be corrected by a certain factor.

Alternatively, the correction can be done by an external value (e.g. via connected pyrometer) by choosing the process interface **PIF in** (please also see **2.5**).

There are several **Fitting modes** to adjust the thermal image:

Auto	The software is choosing the best way of correcting the image (offset or gain).
Offset	This kind of correction is recommended if there are big temperature differences between the reference temperature value and the thermal image.
Gain	This kind of correction is recommended if there are small temperature differences between the reference temperature value and the thermal image.

Keep referencing if value of reference area is below: x [°C]: No new reference is made if the reference sensor does not reach the temperature.

Keep referencing if value of reference area is below: x [°C]: No new reference is made if the reference measurement area does not reach the temperature. The setting is required to detect that no material (e.g. glass) is present.

Ignore pixels higher than (based on $\epsilon = 1,0$): Pixels above a certain blackbody temperature that should not be included in the calculation of the reference measure area can be ignored. This means that hot glass edges are not taken into account for low-emissivity glass. In addition, for each invalid pixel you can specify how many neighboring pixels should also be considered invalid. For setup, the ignored pixels can be colored black.

Emissivity limits: A typical emissivity for the process should be specified here.

2.4.6. Changing the optics (only PI)

Using the menu **Tools**, **Configuration** and **Device** the **Optics** depending on the camera configuration must be chosen. As a standard the camera can be delivered with different type of lenses. If the camera is ordered with several additional lenses the currently used optics must be chosen in this menu (only for PI series).

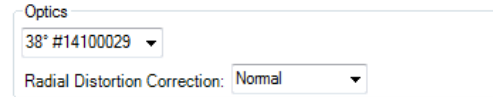

With the help of the menu point **Radial Distortion Correction**, the camera image can be corrected in such a way that the image distortion is compensated by the optics (barrel distortion). This distortion occurs especially in wide-angle optics. It can be selected between **Off**, **Normal** and **Wide**.

The wide mode is designed primarily for line scanning applications with scanning on the diagonal. This ensures full use of the optics when the distortion correction is activated.

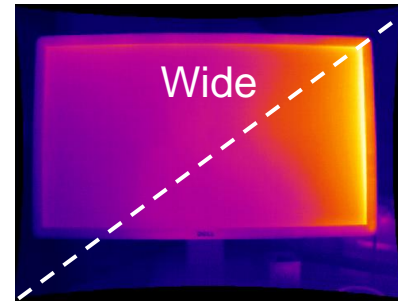
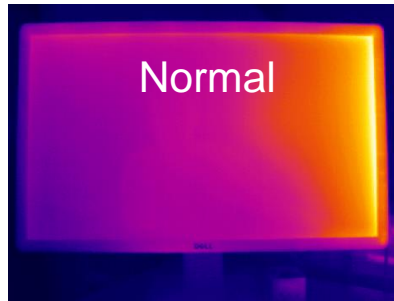
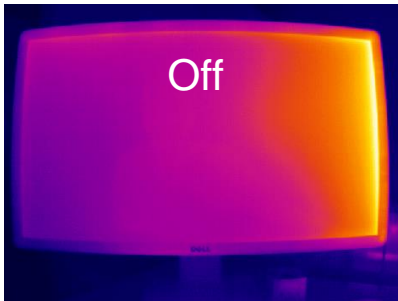

2.4.7. Changing the temperature range

Using the menu **Tools**, **Configuration** and **Device** the most suitable **Temperature range** for the process can be set. The imager features different temperature ranges depending on the device.

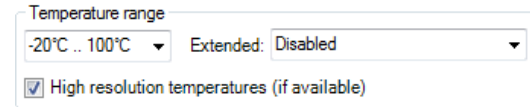

Alternatively, the temperature range can also be changed via the status bar in the PIX Connect software window. To do this, make a right-click on the temperature range.

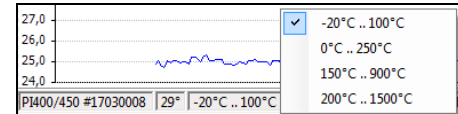

A useful function is the adjustable, extended temperature range under **Extended**. The temperature range 150 °C ... 900 °C can be extended from 20 °C. The accuracy between 20 °C ... 150 °C is no longer exact. This function is used to display an IR image with or without temperatures between 20 °C ... 150 °C. This is especially useful if an IR image is to be displayed between the hot processes.

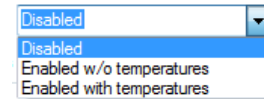

Note

The extended temperature range is usable for all PI 160 /2xx /4xxi /640 cameras, calibrated from March 2017 onwards and for all Xi cameras.

With **High resolution temperatures (if available)**, the temperature display has two decimal places instead of one decimal place. This function is only available for certain camera models.

2.4.8. Video formats (Device framerate)

The cameras have different framerates. To change this, go to **Tools**, **Configuration** and **Device** in the menu.

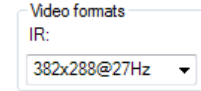

Alternatively, the device framerate can also be changed via the status bar in the PIX Connect software window. To do this, click on the device framerate with the right mouse button.



With the camera PI 1M/ 08M/ 05M, the user has the possibility to choose the 1 kHz mode. If this is selected, a window appears with the information that the clipped format will be changed and the position of the section itself can be set.

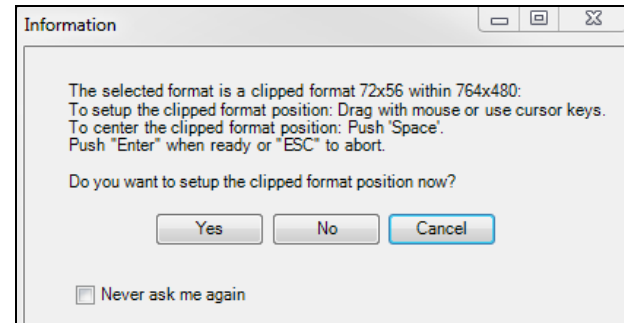

2.5. Imager interfaces for PI and Xi 400 camera

2.5.1. General

The imager is equipped with a process interface (cable with integrated electronics and terminal block), which can be programmed via the software as an Analog Input (**AI**) and Digital Input (**DI**) in order to control the camera or as an Analog Output (**AO**) in order to control the process. The signal level is always **0-10 V**. The process interface can be activated choosing the following options:



- Analog Input (**AI**): Emissivity, Ambient temperature, Reference temperature, Uncommitted value, Flag Control, Triggered Snapshots, Triggered Recording, Triggered Linescanner, Triggered event grabber, Reset Peak-/Valley-Hold, Switch temperature range
- Analog Output (**AO**): Main measure area, Measure area, Internal temperature, Flag Status, Recording Status, Line scan status, Alarm, Frame sync, Fail-safe, External Communication, Center pixel (direct output)*
- Digital Input (**DI**): Flag Control, Triggered Snapshots, Triggered Recording, Triggered Linescanner, Triggered event grabber, Reset Peak-/Valley-Hold, Switch temperature range

* Function only available for models PI 1M/ 08M/ 05M

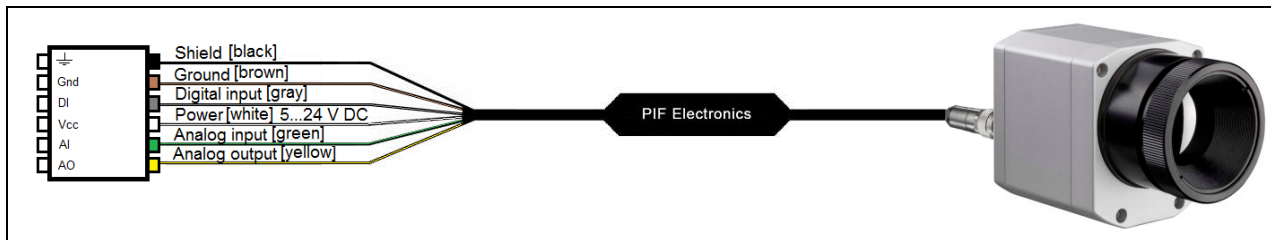

Configuration Process Interface (PIF)

Uncommitted value: Here, an external value (e.g. pressure) can be integrated into the software.

Frame synchronization: In this function, a needle pulse is output for synchronization with fast processes at the beginning of each frame.

Center pixel (direct output): At a frame rate (e.g. 1 kHz), the center pixels of 8x8 pixels of the selected format (e.g. 72x56 pixels) are always used and are available as a direct output. A real-time analog output (1 ms) is realized. The window-operating delay has no influence on the output time. The format section (e.g. 72x56 pixels) can be freely positioned in the entire available FOV. This feature is only available for the PI 1M/ 08M/ 05M models.

2.5.2. Process interface (PIF)

Using **Tools**, **Configuration** and **Device PIF** menu you can configure a PIF which is connected to the camera. The number of in- and outputs can vary depending on the connected PIF (Standard-PIF or Industrial PIF). An available in- or output will be marked with a green checkmark (✓). A not available in- or output will

be marked with a red **x**. With **Show all available in-/outputs**, only the available inputs/outputs are displayed.

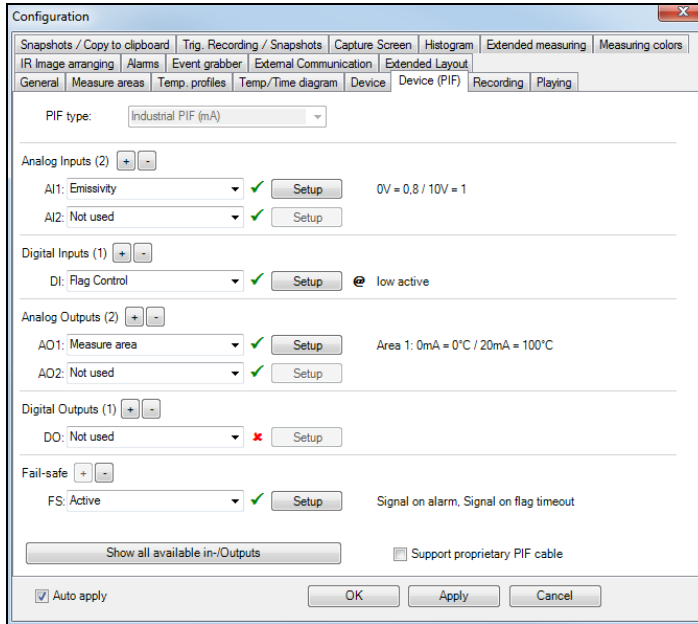

If you configure an analog value an additional window will show up if you press the **Setup** button. In this window you can scale the in- or output:

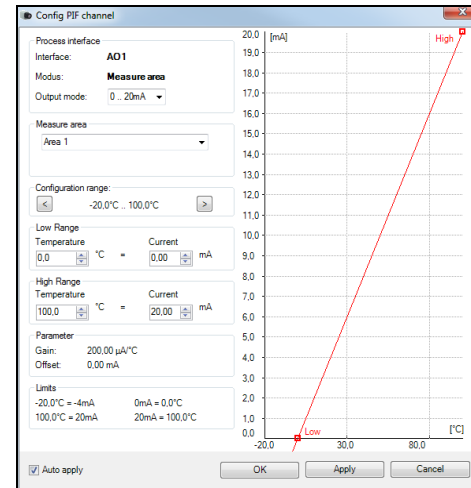

On the analog inputs you can select each function only once (exception: Uncommitted value).
On the analog outputs also each function can only be selected once (exception: Measurement area; Alarm).

**Note**

You can use the analog inputs, outputs and the digital input of the PIF simultaneously.

**Note**

The alarm output can be configured as a threshold between **0-4 mA** for **no alarm** and between **10-20 mA** as **alarm**. For values outside the respective range, the relay does not switch on the DO.

If you activate the function **Alarm** on an analog output you need to assign also in the **Alarms** tab the desired measurement area to the desired PIF output.

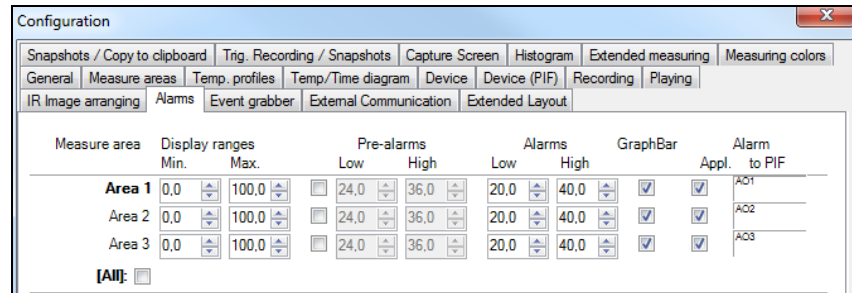

The industrial PIF has a maximum of three analog outputs. To use additional outputs, the ADAM-4024 module from Advantech is recommended, which has four analog outputs per module and can be cascaded with further modules.

For more information on the settings for alarms, see section **4.8 Alarms**.

The process interface has an integrated fail-safe mode. This allows to control conditions like interruption of cables, shut-down of the software etc. and to give out these conditions as an alarm. The time constant of the fail-safe is 1.5 seconds.

Controlled conditions on camera and software	Standard Process interface ACXIPIF	Industrial Process interface ACPIFMACBxx
Interruption USB cable to camera	✓	✓
Interruption data cable camera – PIF	✓	✓
Interruption power supply PIF	✓	✓
Shut-down of software	✓	✓
Crash of software	-	✓
Fail-Safe output	0 V at analog output (AO)	Open contact (Fail-safe relay) / green LED on

The failsafe function can be activated in the tab **Device (PIF)** under **FS**. The industrial PIF has a separate failsafe relay. Alternatively you can activate this function also on the analog outputs. The checkbox **Stop fail-safe pulse on alarm** must be activated, if the analog output should be used in addition as an alarm output for a temperature alarm. In case of an alarm the alternating fail-safe pulse signal will stop and the set voltage level will be given out as constant value (Industrial PIF only).

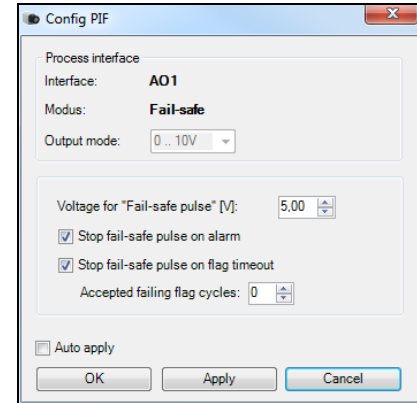

2.6. Software Development Kit (SDK)

2.6.1. Interprocess Communication (IPC)

Tools, **Configuration**, **External Communication** and **Interprocess Communication (IPC)** enables you to embed **colors**, **temperatures** or **ADU values** into other applications via Dynamic Link Library (DLL). In addition, a **Timeout** can be set when the connection has been interrupted. The **Internal buffer size** is the size of the queue between PIX Connect and Connect SDK (unit: frames).

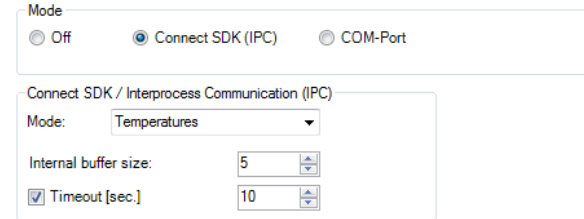

Mode

Off Connect SDK (IPC) COM-Port

Connect SDK / Interprocess Communication (IPC)

Mode:

Internal buffer size:

Timeout [sec.]



Note

The command list (*Connect SDK Description-xxxx-xx*) can be found on the USB stick under Documentation and Manuals.

2.6.2. COM-Port

You can activate the feature in the **Tools**, **Configuration**, **External Communication** and **Comport** menu.

If selected the data values sent out by the camera can be transmitted via specified **Port**. The **Baud rate** can be changed (from 1200 to 921600) accordingly. The **Bus address** is used to assign an unique address to each participant.

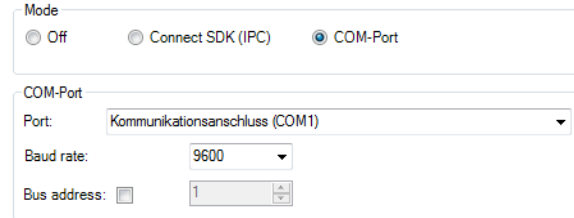

Note



Two software development kits are offered: **Connect SDK** (provides a very large range of functions, PIX Connect software must run as a background process) and **Direct SDK** (does not require PIX Connect software, the library "libirimager" provides a C++ interface for Linux and Windows). You will find more details on using the SDKs on the USB stick provided.

Note



The command list (*Serial Communication Description-xxxx-xx*) can be found on the USB stick under Documentation and Manuals.



Software Tutorial
LABview integration
<https://www.optris.global/labview-integration-via-virtual-com-ports>

2.6.3. Web Server

Over **Tools**, **Configuration**, **External Communication** and **Web Server** the camera image can be transmitted via a corresponding client such as a web browser.

Under **Mode** you can select which section is to be transferred. The following can be selected: **Fullscreen**, **Application**, **IR image only** or **User Defined**.

Under Server Settings the **Port** and the **Framerate** can be selected.

In addition, the host must be selected under **IP-Address for Link**.

The screenshot shows the 'Web Server' configuration window. The 'Mode' section has 'Web Server' selected. The 'Mode' section below has 'Application' selected. The 'Server Settings' section shows 'Port' set to 8080 and 'Framerate [Hz]' set to 20. The 'Server Status' is 'Server is Stopped' in a red bar. The 'Link' is 'http://127.0.0.1:8080' and 'Autostart' is unchecked. The 'IP-Address for Link' is 'Localhost (127.0.0.1)'.

The screenshot shows the 'Web Server' configuration window. The 'Server Status' is 'Server is running' in a green bar. The 'Link' is 'http://192.168.49.180:8080' and 'Autostart' is checked. The 'IP-Address for Link' is 'Realtek USB GbE Family Controller #4 (192.168.49.180)'. The 'Port' is 8080 and 'Framerate [Hz]' is 20.

To start streaming, the application must be started via **Start**. If everything has been configured correctly, the message **Server is running** appears in green. The link with the corresponding port number is displayed and can be selected directly here.

2.6.4. Direct temperature mode (only for Xi 80 and Xi 410)

A special feature of the Xi 80 and Xi 410 cameras is that the temperature calculation can be calculated in the device. To activate this special mode, go to **Tools**, **Configuration** and **External communication** to **Direct temperature mode**.

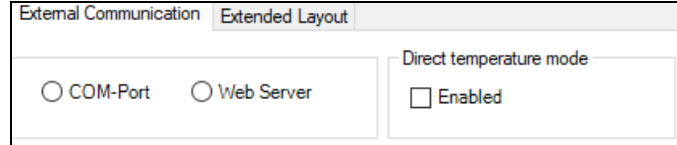

If the mode has been activated, the mode is marked extra in the IR image with **temperature mode**.

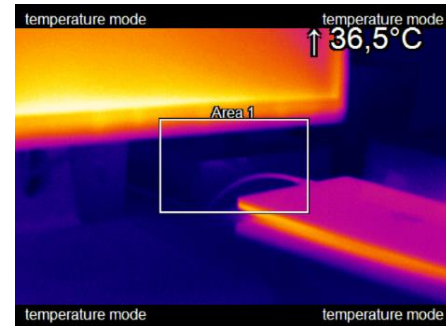

Note



A detailed description (*Optris Easy Comm via Ethernet*) can be found on the USB stick under SDK and **Easy Comm**. Easy Comm is a small and simple software solution for developers who want to have direct access to temperature data from the infrared cameras. The complex temperature calculation is completely processed in the device and the user of Easy Comm gets the temperature information of all pixels.

2.7. Start options

2.7.1. Overview of start options

PIX Connect software can be started with additional starting parameters using the command line. Please change the linkage in the software settings via the launch icon on the desktop. Behind the command line please add a space character and the required command parameter, e.g. **"C:\Program\...\PIX Connect\Imager.exe" /?**

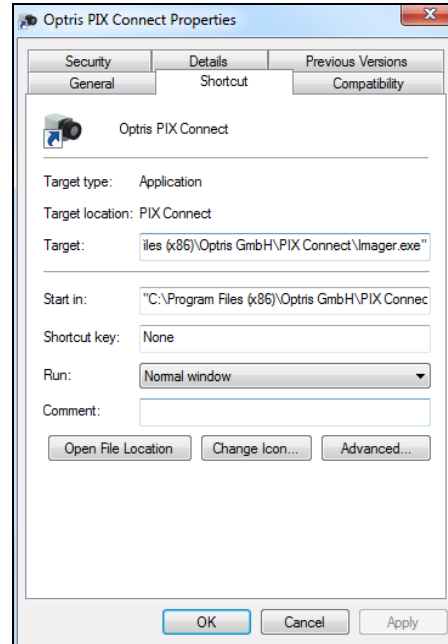

Starting the software via the launch icon you will get an overview of possible commands:

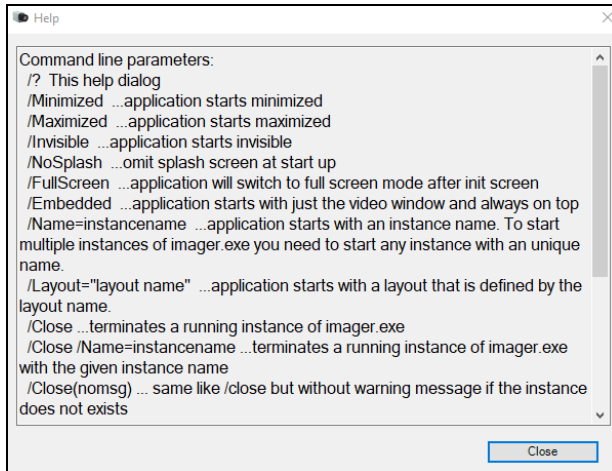

Help

Command line parameters:

- ? This help dialog
- /Minimized ...application starts minimized
- /Maximized ...application starts maximized
- /Invisible ...application starts invisible
- /NoSplash ...omit splash screen at start up
- /FullScreen ...application will switch to full screen mode after init screen
- /Embedded ...application starts with just the video window and always on top
- /Name=instancename ...application starts with an instance name. To start multiple instances of imager.exe you need to start any instance with a unique name.
- /Layout="layout name" ...application starts with a layout that is defined by the layout name.
- /Close ...terminates a running instance of imager.exe
- /Close /Name=instancename ...terminates a running instance of imager.exe with the given instance name
- /Close(nomsg) ... same like /close but without warning message if the instance does not exists

Close

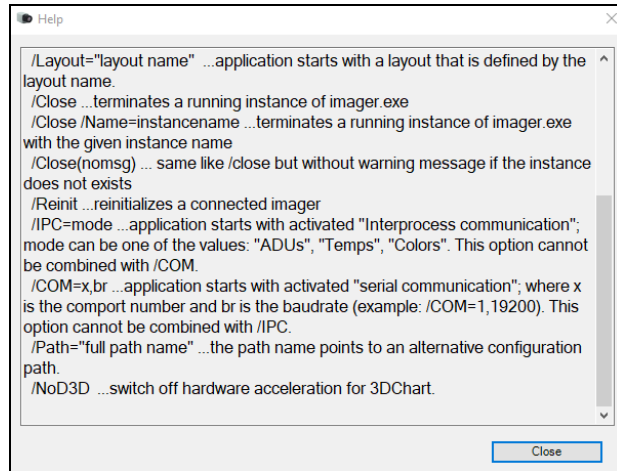

Help

- /Layout="layout name" ...application starts with a layout that is defined by the layout name.
- /Close ...terminates a running instance of imager.exe
- /Close /Name=instancename ...terminates a running instance of imager.exe with the given instance name
- /Close(nomsg) ... same like /close but without warning message if the instance does not exists
- /Reinit ...reinitializes a connected imager
- /IPC=mode ...application starts with activated "Interprocess communication"; mode can be one of the values: "ADUs", "Temps", "Colors". This option cannot be combined with /COM.
- /COM=x,br ...application starts with activated "serial communication"; where x is the comport number and br is the baudrate (example: /COM=1,19200). This option cannot be combined with /IPC.
- /Path="full path name" ...the path name points to an alternative configuration path.
- /NoD3D ...switch off hardware acceleration for 3DChart.

Close



Note

Using the parameter Invisible the software can only be closed via the **Task Manager** and **Processes**.

2.7.2. Start of multiple software / imager instances

In case you are using more than one PI simultaneously each imager can be linked to one software instance. In order to setup further software instance please follow the steps below:

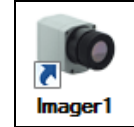

- 1.) Duplicate the software icon at the desktop
- 2.) Optional: Change the name of the new software icon at the desktop, e.g. „Imager1“
Make a right click on the new icon, click on Properties, go to Shortcut and Target and at the end of the line type the new name in:
"C:\Programme\...\PIX Connect\Imager.exe" **/Name=Imager1**
(see **2.7.1**)
- 3.) Optional: Change the title name using the start parameter (see **2.1.5**)
- 4.) Start the software using the new software icon
- 5.) Link a camera to the new software instance in the PIX Connect software

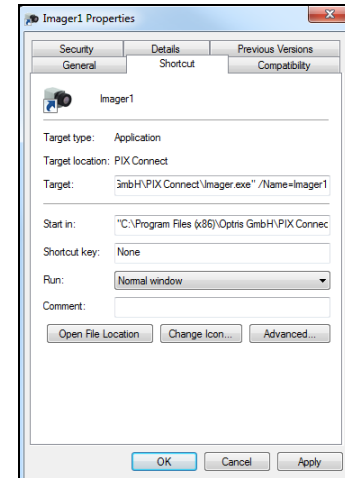

In order to set up the last step please go to menu **Tools**, **Configuration** and **Device** and select in **Application start** the favored imager for the respective software instance.

Starting the software via the new desktop icon the linked imager will be displayed automatically. SN is the serial number of the individual camera.

Application start:

Connect to device with SN:



Note

Each imager can only be linked to **one** software instance.



Note

It is recommended to connect at first one camera and to do the steps 1 till 5 and afterwards start with the second camera etc., so that no possible interference is caused.

3. Data capturing

3.1. Open files



Via the menu **File** and **Open** or the **Icon** on the toolbar you can open all files which can be processed by the software.



Note

Via the menu **File** and **Reopen** you can easily reopen captured files if the option in **3.4.6** is activated.

3.2. Replay of files

3.2.1. Control panel

In order to replay a video sequence you can use different options in the **File** menu or at the control panel. The video control panel contains:



- | | | | |
|--|----------------|--|---------------------|
| | Start | | End |
| | Rewind | | Play |
| | Previous image | | Pause |
| | Next image | | Play in loop |
| | Forward | | Play selection only |

3.2.2. Replay options

Via the menu **Tools**, **Configuration**, **Playing** and **Playing options** you can modify the **Play rate** of recorded video sequences. This feature ensures that you can replay a video of a fast process in slow motion in order to analyze it in more details.

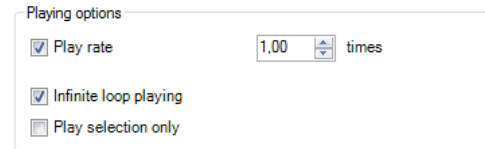

Additionally, you can define to replay a recorded video in a loop (**Infinite loop playing**) or to **Play selection only**. To define a selection the position marks on the time bar needs to be set. All mentioned settings can also be changed via the control panels below the main window.



Note

The replay settings only refer to the current file shown in the main window. All definitions, however, can be saved in an individual layout assigned to the file.

The software allows you to change measurement parameters later on. Via the menu **Tools**, **Configuration**, **Playing** and **While playing use this alternative values and settings** you can adjust the parameters **Emissivity**, **Ambient temperature** and **Transmissivity** to the measurement conditions. Above that, via **Disable recorded Reference temperature** you can deactivate reference value stored in the file.

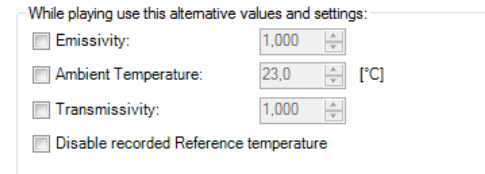

3.3. Editing video sequences

The selected video can be edited by using **Trim to selection** option in the **Edit** menu.

A time bar tool is shown on the bottom of the image. Set the position marks on the time bar to select the beginning and end of the video sequence you want to be edited. The not selected video sequence parts (bright grey) will be deleted by choosing **Trim to selection** option. The selected video sequence (dark grey) will remain.

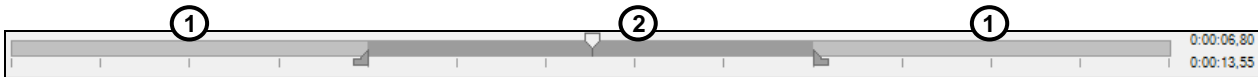

3.4. Saving files

3.4.1. Setting the recording frame rate

The camera's maximum frame rate depends on the camera model you're using and can be reduced. Using **Tools**, **Configuration**, **Recording** and **Recording framerate** the speed of the data capturing can be set. Typically, the specification is in Hertz (Hz, images per second).

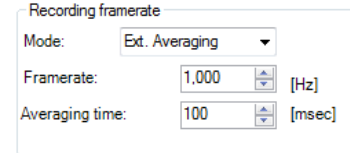

The software gets the full frame rate from camera. That is why you need to define what to do with the images which are left if choosing a reduced frame rate. There are several alternatives to set in the **Mode** option:

Off	The recording frame rate corresponds to the device frame rate of the camera.
Skipping	It skips so many pictures that the set display frame rate results.
Average	The pixels are averaged out of a sequence of images. This weakens the detector noise.
Minimum	From a sequence of image, the smallest value is displayed for each pixel.
Maximum	From a sequence of image, the highest value is displayed for each pixel.
Ext. Averaging	Is a combination of average and skipping and is used at very low frame rates. The averaging time indicates how many percent of the set frame time should be averaged. In the remaining time, the frames are skipped (e.g., if the frame rate is 1 Hz and the averaging time is 100 ms, then 100 ms is averaged and 900 ms is skipped).

Example: Recording frame rate of 4 Hz
(output signal of 25 images)

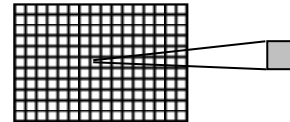
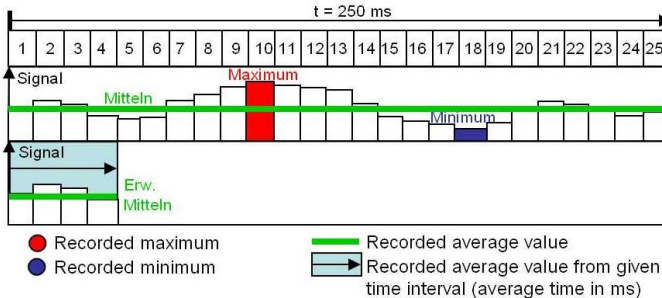

Recording frame rate referring to 1 pixel

3.4.2. Setting the recording modes

If desired the **Recording time limit** sets fixed recording time in seconds (max. 86400 seconds = 24 hours). After reaching the time limit the software stops the recording.

If a manual recording is to be started with a defined time duration, the **Use limit for manual recording** option must be activated.

General recording settings

Recording time limit: [sec]

Use limit for manual recording

Save after recording is stopped

Play after recording is stopped (not during merging)

Choosing the option **Save after recording is stopped** the images will be saved without further notice.

If the option **Play after recording is stopped** is activated the saved images will be played automatically in the main window. The recording contains radiometric Videos (RAVI file) which allow users to do a detailed post-analysis anytime later. Moreover, new measure areas and alarms can be created in addition to recorded data when doing the analysis. The temperature value of each pixel as well as information on defined measure areas is recorded.



Note

The status of recording is displayed at the bottom notice bar. The background color will turn **RED** when recording.

PI400/450 #17030008 Recording: 00:00:31 178,1MB

By activating the **Advanced recording** function, the recording is started immediately and without delay.

Advanced recording

Trigger time

Pre-Trigger [sec] Trigger delay

< >

-26 26

A special feature of this function is also the possibility to configure a recording by a **Trigger time** with a **Pre-Trigger** or a **Trigger delay**. This means that it is possible to make a recording in the past. When an alarm condition occurs, it is possible to start the recording a few seconds earlier or later by setting a trigger time. This ensures that the event is recorded completely. The length of the recording can be defined by **Recording time limit**.

3.4.3. Temporary recording file

Choose the directory for saving your temporarily recorded video file.

Temporary recording file

C:\Users\Max Mustermann\AppData\Roaming\Imager\temp.~avi

Estimated file size: 2,1MB/sec; 126,3MB/min; 7,4GB/h

The **Estimated file size** is estimated to indicate the amount of megabits needed or consumed. It can be checked whether the available hard disk is sufficient for the desired recording time.



Note

This temporary file will be overwritten with each new recording.

3.4.4. Saving radiometric video sequences

Video sequences are saved as a radiometric file (RAVI). RAVI files contain all temperature as well as measure area information.



For recording a video sequence you can use either the menu **File** and **Record** or the available **Icon** on the toolbar.



For stopping a video sequence you can use either the menu **File** and **Stop** or the available **Icon** on the toolbar.



If the video sequence includes the expected content you can save it via the menu **File** and **Save** or the **Icon** on the toolbar.

3.4.5. Saving image data as radiometric snapshot or text file

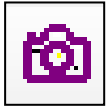

Snapshots are single, radiometric images based on a video sequence, this means they contain all temperature as well as measure area information. Thus the images can always be analyzed in detail later on.

Snapshots can be captured via the menu **File** and **Snapshot** or via the **Icon** on the toolbar.

Using the settings in the menu **Tools**, **Configuration** and **Snapshots / Copy to clipboard** you can define how a snapshot is copied into the clipboard or stored on the computer. Either the snapshot will be saved in the **Genuine (device resolution)** corresponding to the camera's resolution, **Magnified** (Magnification for PI 160, PI 2xx to four times the resolution, for PI 4xxi to double, and for PI 640 and PI 1M/ 08M/ 05M, the original device resolution remains) or using **As video window** (as illustrated video window). The option **Draw overlay information** will display all information, such as measuring area or temperature display and is stored on the image. If the checkmark is not set, only the pure thermal image is stored without values and information.

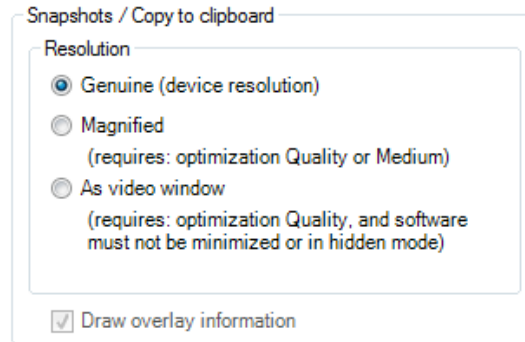

Note



The option **Genuine (device resolution)** needs to be chosen if you want to save and display (snapshot history) the identical snapshot. Otherwise, the camera image taken before the snapshot will be displayed in the history.

If the option **Open a file dialog** is tagged you will always be asked about the location, the file name and the file type before saving a snapshot.

Having chosen the option **Generate filename by template** the snapshots location and name will be generated based on the settings in the menu **Tools**, **Configuration** and **Trig. Recording / Snapshots** (please see section 3.4.6).

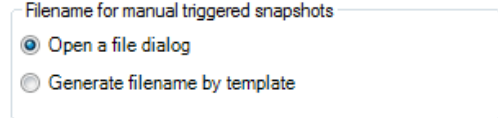

Filename for manual triggered snapshots

Open a file dialog

Generate filename by template

In the **Tools**, **Configuration** and **Trig. Recording / Snapshots** menu you define the **File type for triggered snapshots**.



File type for triggered snapshots: TIFF (*.tiff)

The option **Max. triggered snapshots** sets the number of displayed snapshots in the separate window Snapshot history (please see section 2.2.1).

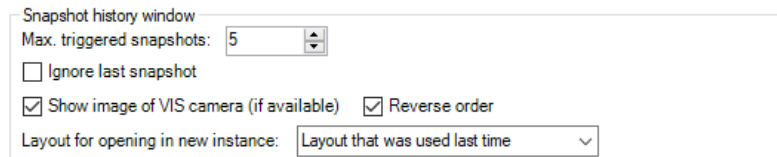

Snapshot history window

Max. triggered snapshots: 5

Ignore last snapshot

Show image of VIS camera (if available) Reverse order

Layout for opening in new instance: Layout that was used last time

If **Ignore last snapshot** is activated only the latest snapshot will be displayed in the Snapshot history window if a new snapshot is captured.

Show image of VIS camera (if available) implies that the visible image if available will be saved too.

Reverse order implies that the sequence of the pictures will be shown in the snapshot history in reverse order.

Create link in “reopen file” list for triggered video sequences and snapshots implies that the snapshots or triggered videos are listed under **File** and **Reopen**.

There are the following options to save image data:

TIFF (*.tiff)	Saving of image (snapshot) as radiometric picture in TIFF format.
Text (Image data) (*.csv)	Saving of image (snapshot) as Text format to edit information in Excel.
Text (Temp. profile data) (*.csv)	Saving of temperature profile data only as Text format to edit information in Excel.

Note



The TIFF files are saved as radiometric files and can be analyzed in detail with the PIX Connect software. Furthermore, they can also be displayed in any standard program like Photoshop showing the color information within the image.

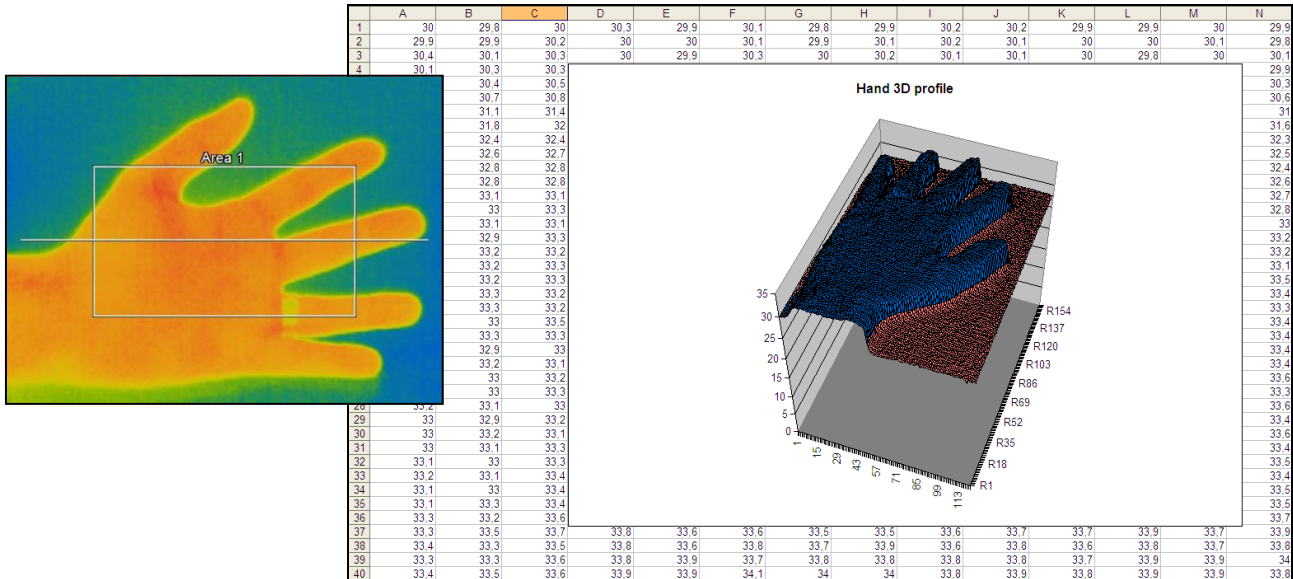

Analysis of thermal image in Excel via *.csv file export and display of pixel data in 3D

Subdirectory: When creating snapshots, they can be automatically saved in subfolders for a better overview. The following selection is available:

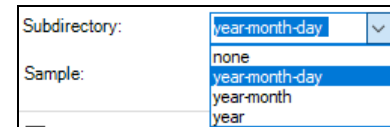

3.4.6. Saving text file of the temperature / time diagram

Via the menu **File** and **Save Temp/Time diagram data** the data of diagram can be saved in a text file (*.dat) for further analysis.

3.4.7. Location and filename templates of triggered recordings

In the **Tools**, **Configuration** and **Trig. Recording / Snapshots** menu you can define a **Prefix for filename**. The software is using this prefix if saving a sequence or snapshot.

The **Path** defines the storage location of all files and can be changed here. Once recorded the file is saved under name including prefix, current date and time stamp.

File name template for triggered recording and snapshots

Prefix for filename:	<input type="text" value="Record"/>	
Path:	<input type="text" value="C:\"/>	<input type="button" value="Browse"/>
Sample:	<input type="text" value="C:\Record_2016-10-21_10-06-46.ravi"/>	

Note



Using the option **Create link in “reopen file“ list for triggered video sequences and snapshots** the files can easily be reopened via the menu **File** and **Reopen**.

The data capturing includes all information like measure areas and temperature displays of the main window if the option **Save layout together with triggered video sequences and snapshots** is tagged.

3.4.8. Display of snapshots in a separate window



In the menu **View**, **Windows** and **Snapshot history** or over the icon you can activate a window in order to display all triggered snapshots (please also see section 2.2.1). Before you have to choose the option Generate filename by template in the menu **Tools**, **Configuration** and **Trig. Recording / Snapshots** (please see section 3.4.5).

If a shot snapshot is to be opened from the snapshot history, there are several options:

Open: Opens the snapshot in the same instance (see also section 3.1)

Open in new instance: Opens the snapshot in a new instance

Delete: Snapshot is deleted

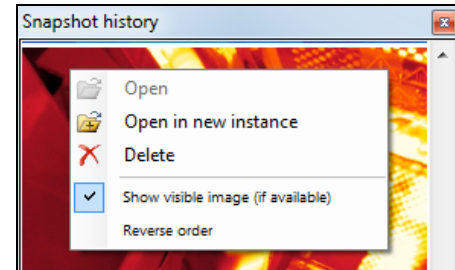

Show Visible Image (if available) displays the additional visual image on the PI 200/230 camera.

Reverse order: The snapshot history is displayed in reverse order.

In the configuration dialog in the tab **Trig. Recording / Snapshots** you can set with which layout the snapshot should be opened in the new instance. You can choose between the following settings:

Layout that was used last time (default setting): Layout that was last opened in the viewer instance.

Current layout from this instance: Layout that is currently open in the current instance.

Layout within the file: Layout that is contained in the file that is to be opened.

Configuration

General Measure areas Temp. profiles Temp./Time diagram Device Device (PIF) Referencing Recording
IR Image arranging Alarms Event grabber External Communication Extended Layout
Snapshots / Copy to clipboard Trig. Recording / Snapshots Capture Screen Histogram Extended measuring

File name template for triggered recording and snapshots

Prefix for filename: Record

Path: C:\Users\Documents\Imager Data

Subdirectory: none

Sample: C:\Users\Documents\Imager Data\Record_2020-12-07_09-47-40

Auto-save triggered video recordings to file

File type for triggered snapshots: TIFF (*.tiff)

Snapshot history window

Max. triggered snapshots: 5

Ignore last snapshot

Show image of VIS camera (if available) Reverse order

Layout for opening in new instance:

Create link in "reopen file" list for

Time controlled recording / snapshotting

Current layout from this instance
Layout within the file

3.4.9. Saving images or screenshots to clipboard



Using the **File**, **Snapshot** and **Copy to clipboard** menu or the **Icon** on the toolbar the image of the main window can be copied to the clipboard in order to paste it into different programs such as MS Word.



Alternatively, you can also copy the whole software window (screenshot) to the clipboard using the **File**, **Screenshot** and **Copy to clipboard** menu.

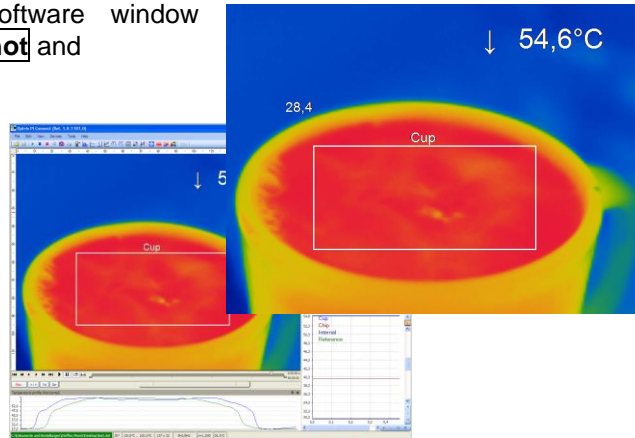

Note

The whole software window can also be saved using the **File**, **Screenshot** and **Save** menu or the **Icon** on the toolbar.

3.4.10. Capture Screen



The software offers the possibility to make a screen recording (wmv format). To start a Capture screen, go to **File**, **Capture screen**, and **Capture screen**. Alternatively, you can also press the F7 key or the adjacent icon.



The replay of the last Capture screen recording can be started under **File**, **Capture screen** and **Replay captured screen**. Alternatively, press the Alt + F7 key or the adjacent icon.

The following setting options can be found in the configuration menu under the tab **Capture screen**.

Under **Capture mode**, you can choose between **Application** (PIX Connect window), **Fullscreen** (whole window of screen), and **Imager only** (IR screen only).

Capture mode

Application Fullscreen Imager only

At **Capture framerate**, you can enter the **Framerate** at which the recording is to be recorded.

Capture framerate

Framerate: 10 [Hz]

Under **General capture settings**, you can select whether the mouse **Capture Cursor** is to be recorded and what is the **Minimum Duration** of the recording.

General capture settings

Capture Cursor Minimum Duration 6 [s]

The temporary screen capture file is stored in the following path:

Temporary screen capture file

C:\Users\AppData\Roaming\Imager\temp_~wmv

Browse

Under Filename mode, you can decide how and where to save a recording. You can choose between the following options:

Filename mode

Open a file dialog

Generate file name by template

Prefix for filename:

Path:

Sample:

Static filename

Open a file dialog: After recording, a dialog window will pop up, prompting you to enter a location and a save name.

Generate file name by template: Here you can enter a Prefix for filename, a Path and a Sample for the recording.

Static filename: Under the name and path entered here, the recording is automatically saved. The file is overwritten with each new recording.



Note

If during the recording the software window is made smaller or larger, the size remains from the start.

4. Data processing

4.1. Measure areas

4.1.1. General settings

Measure areas for temperature analysis can be defined, edited and deleted using the menu **Tools**, **Configuration** and **Measure areas**. The value of a measuring area is updated every 100 ms*. This also applies to the output of the analog values on the PIF.

Using **Add (Measure Area)** / **Add (Calculated area)** buttons you can create a new Measure area / Calculated area. The **Remove** button deletes an existing Measure area / Calculated area.

Press **Up** / **Down** to position individual measure areas within the list.







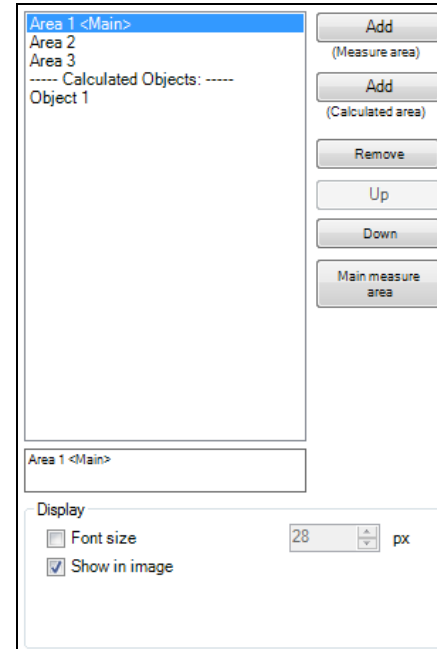

One measure area from the list can be appointed as the **Main measure area**. The temperature of the main area can be displayed in the main window or converted into an electrical signal to be transmitted via the Process Interface (PIF)

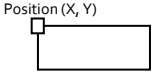
Under **Display** the **font size** can be changed for all measuring areas. By selecting **Show in image** measure areas can be displayed in the infrared image.

* The value can be delayed because it works with a Windows timer.

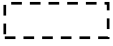

Available measure area shapes are:

	User defined rectangle
	Measure point (1x1)
	Measure point (2x2)
	Measure point (3x3)
	Measure point (5x5)
	Ellipse
	Polygon
	Curve (Spline)
	Super area

Measure area

Name:

Shape:

Mode:

Bind to temperature profile

Emissivity:

Show in digital display group

Use in event grabber

Label in image:

Name

Mode

Value

two lines

Location:

Adjust at border

Position

Location: (Center) X: Y:

Size: Width: Height:

Hot spot

Cold spot



Any **measure area** can be renamed individually in the **Name** field. Under the field **Shape** the different measuring shapes can be selected. The table above shows the available shapes. The temperature of the main measuring area can also be displayed in the main window. Several measuring areas can be bundled into one measuring area via a **super area**.

The value, which is displayed, is defined over the **Minimum, Maximum, Mean value** or **Distribution [%]** in the field **Mode** or via the icon in the toolbar:

- **Minimum:** Min. value is shown
- **Maximum:** Max. value is shown
- **Mean value:** Mean value is shown
- **Distribution [%]:** Indicates the percentage distribution between two selected temperatures
- **Area within Limits:** By specifying the total area of the measuring area and a freely definable unit of measure, the percentage value from the distribution measurement is converted into an area size

In the **Position** section the exact **Location** and **Size** of the measure area within the main window can be defined. The moving and minimizing or maximizing of the measuring areas can also be realized directly at the measuring area in the main window. By moving the cursor to the edges of the measuring area, the grippers can be used to adjust the size of thermal image (alternatively via mouse wheel/touchpad) or to move the image completely (hold **Ctrl** synchronously). To move several measuring areas simultaneously, the key combination **Ctrl** key, left mouse button + mouse movement must be used. If desired the area can represent a **Hot spot** (spot or area with highest mean temperature in the image) or a **Cold spot** (spot or area with lowest mean temperature in the image).

Using **Center** you will be moving the measure area into the middle of the main window, using **Standard size** the rectangle will be set in a predefined size.

Under **Label in image**, you can select whether the **Name**, **Mode** and / or **Value** is to be displayed in the image.

Two-lines means that the selected labels are displayed one after the other. At **Location** the position of the label can be arranged for each created measurement area.

Adjust at border prevents the label from disappearing outside the border.

Using **Bind to temperature profile** you can assign each measure area to one of the two temperature profile (**Profile 1** / **Profile 2**).

The position of the measure area and the profile can be determined by the option **Location [%]**. The size ratio can be defined by the option **Min. Size**.

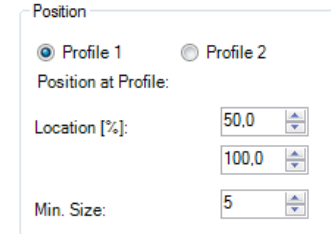

The screenshot shows a configuration panel titled "Position". It contains two radio buttons: "Profile 1" (which is selected) and "Profile 2". Below this is the label "Position at Profile:". There are three input fields, each with a spinner control: "Location [%]" with a value of 50,0; another field with a value of 100,0; and "Min. Size" with a value of 5.

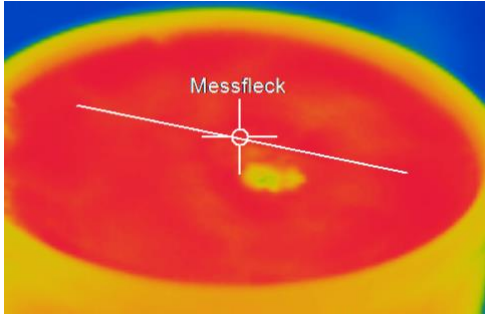

Measure area assigned to a temperature profile
(measure point)

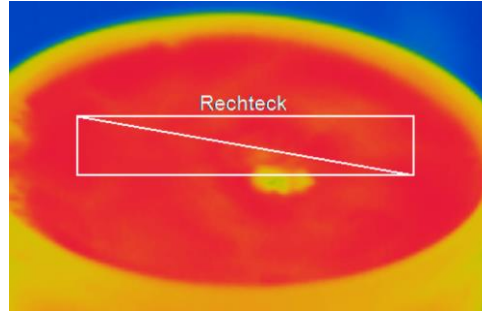

Measure area assigned to a temperature profile
(rectangle)

Under **Emissivity** a different emissivity value can be set for each created measuring area.

In **Show in digital display group**, you can specify which predefined temperature control displays should be displayed in the application window Temperatures (see section **2.2.1**).

With **Use in event grabber**, the selected area will no longer be displayed in the live IR image, but in the event grabber (frozen image) window (see section **4.10**).



Software tutorial
Measure areas
[https://www.optris.global/
software-tutorial-pix-
connect-measure-areas](https://www.optris.global/software-tutorial-pix-connect-measure-areas)



Software Tutorial
Emissivity settings
[https://www.optris.global/
emissivity-settings](https://www.optris.global/emissivity-settings)

4.1.2. Calculated Objects

Calculated objects allow you to select various operations that offer a signal processing. The name for the created object can be changed in the field **Name**. Furthermore, in the field **Show in digital display group**, you can decide whether the object is to be displayed in the digital display group or not. Under **Operation**, you can choose between the following operations:

Off The operation is off.

Difference Calculates the difference temperature of two selected measuring areas (**Operand 1** and **Operand 2**).

Absolute difference The result is a positive number which results from the formation of the difference between two selected measuring areas (**Operand 1** and **Operand 2**).

Average In this mode an arithmetic algorithm will be performed to smoothen the signal. The **Averaging time [sec]** is the time constant. This function can be combined with all other post processing functions. If activated (**Smart averaging [°C]**), a dynamic average adaptation at high signal edges is active.

Peak Hold This function keeps the respective signal maximum. When the temperature drops, the algorithm keeps the signal level for the set **Hold time [sec]**. After the hold time the signal will drop down to the second highest value or will descend by 1/8 of the difference between the previous peak and the minimum value

The screenshot shows a configuration window titled "Calculation". It contains the following fields and controls:

- Name:** A text input field containing "Object 1".
- Show in digital display group:** A checked checkbox.
- Operation:** A dropdown menu with "Average" selected.
- Operand:** A dropdown menu with "Area 1" selected.
- Averaging time [sec]:** A numeric input field with "0,0" and up/down arrow buttons.
- Smart averaging [°C]:** A checkbox that is unchecked, followed by a numeric input field with "0,0" and up/down arrow buttons.

At the bottom of the window, the text "Average (Area 1)" is displayed.

during the hold time. This value will be held again for the specified time. After this the signal will drop down with slow time constant and will follow the current object temperature. Therefore, if periodic events will be measured (bottles on a conveyor e.g.) this peak hold function avoids a drop down of the signal to the conveyor temperature in-between 2 events.

Valley Hold

With this function the respective signal minimum is held. If the signal ascends the algorithm maintains the previous signal valley for the specified **Hold time [sec]**. The definition of the algorithm is according to the peak hold algorithm (inverted).

Adv. Peak Hold

This algorithm searches for local maximum values. Peak values which are lower than their predecessors will only be taken over if the temperature has fallen below the **Threshold [°C]** value beforehand. If **Hysteresis [°C]** is activated a peak in addition must decrease by the value of the hysteresis before the algorithm takes it as a new peak value.

Adv. Valley Hold

This function behaves inverted to the extended maximum search. This algorithm searches for local minimum values. Minimum values which are higher than their predecessors will only be taken over if the temperature has exceeded the **Threshold [°C]** value beforehand. If **Hysteresis [°C]** is activated a minima in addition must increase by the value of the hysteresis before the algorithm takes it as a new minimum value.



Note

The hold time for the peak/ valley hold can be set to infinity by entering 999 s.

Hold time [sec]:	999,0
------------------	-------

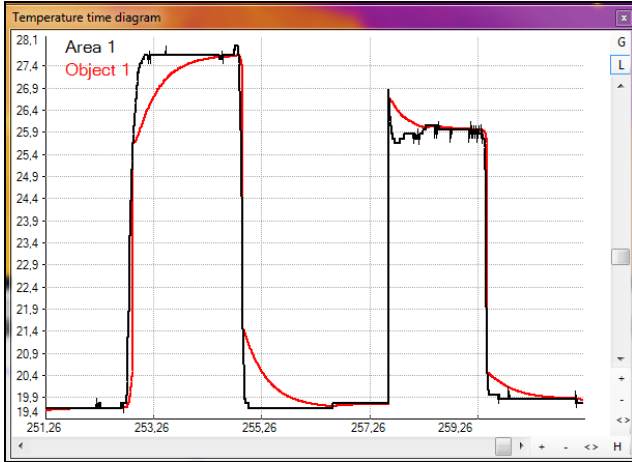

- Area 1 without post processing
- Object 1 with averaging time and smart avagering

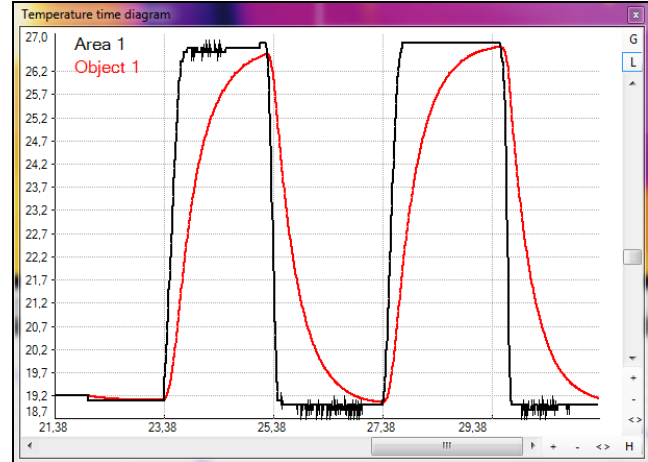

- Area 1 without post processing
- Object 1 with averaging time and without smart avagering

4.1.3. Including and excluding hot and cold spot areas

With the menu item **Tools**, **Configuration**, **Measure areas** you can set in the section **Measure area** which areas should be used for a cold/ hotspot. You can decide whether a measuring area should be included or excluded.

Include in Hot/Cold Spot detection: Here you can include certain areas with existing or possibly occurring hot and/or cold spots in the analysis. This means that hot or cold spots are then searched for in these areas.

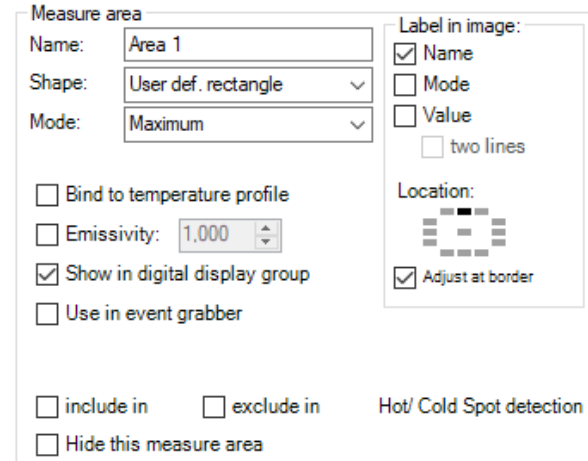

Exclude in Hot/Cold Spot detection: Here, certain screen areas with existing or possibly occurring hot and/or cold spots can be excluded from the analysis. This means that in these areas the search for hot or cold spots is no longer made.

If you select the option **Visualize excluded range (Hot/ Cold spot)** the areas will be shown in the main window. They are indicated by a solid line.

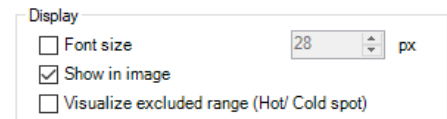

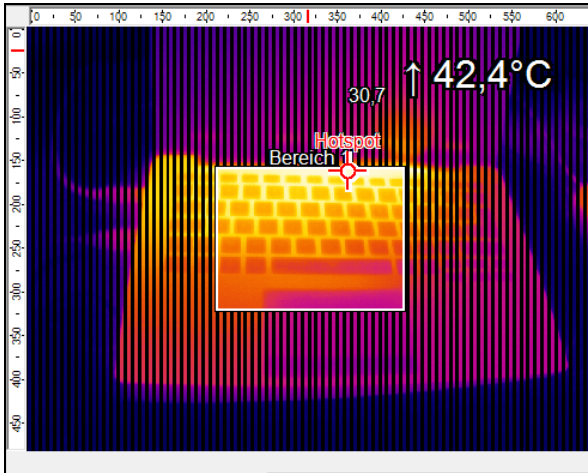

Include

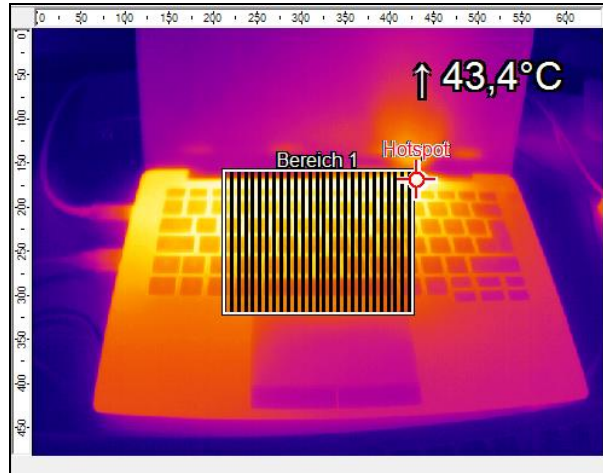

Exclude

4.1.4. Individual emissivity values of measure areas

In case of measuring several materials different emissivity values can be set within the image.

Using the menu **Tools**, **Configuration**, **Measure areas** and **Emissivity** the individual emissivity values can be defined.

The display of the changing temperature values within the measure areas will remain linked to the colors of the reference bar.

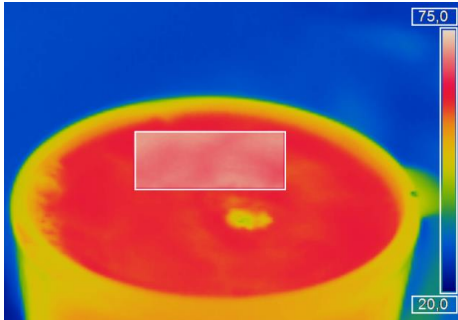

Measure area

Name:

Shape:

Mode:

Bind to temperature profile

Emissivity:

Show in digital display group

Label in image:

- Name
- Mode
- Value
- two lines

Position

Location: X: Y:

(Center)

Size: Width: Height:

Hot spot

Cold spot

4.2. Temperature profile

Up to 2 temperature profiles which graphically reproduce the temperature development can be generated. Therefore go to **Tools**, **Configuration** and **Temp. profiles**. The profiles are labeled as **Profile 1** and **Profile 2**.

The position and size of the profiles can be defined via the coordinates **Start (P1)** and **End (P2)**.

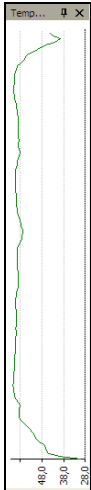

Select **Show in image** if you want the profiles to be displayed in the infrared image in the main window. Alternatively, this setting can be made by choosing the menu **View** and **Image information** (please see section 2.2.3).

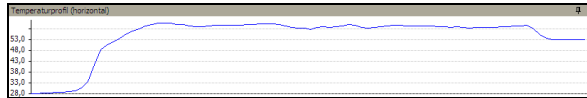

The position and size of the profiles can be also defined by dragging the grippers at the end of the lines within the image of the main window.

The temperature profiles can be displayed in additional windows (please see section 2.2.1).

		Profile 1:	Profile 2:
Start (P1)	X:	5	191
	Y:	144	5
End (P2)	X:	377	191
	Y:	144	283
Show in image:		<input type="checkbox"/>	<input type="checkbox"/>
Show in horizontal diagram:		<input checked="" type="checkbox"/>	<input type="checkbox"/>
Show in vertical diagram:		<input type="checkbox"/>	<input checked="" type="checkbox"/>
<input type="checkbox"/> Show alarm values of main measure area			
<input type="checkbox"/> Show pre-alarm values of main measure area (if enabled)			
<input type="checkbox"/> Use alarm and pre-alarm colors in diagrams			

Using the options **Show in horizontal diagram**, **Show in vertical diagram**, **Show alarm values of main measure area**, **Show pre-alarm values of main measure area** and **Use alarm and pre-alarm colors in diagrams** the profiles can be assigned to the horizontal and / or vertical diagram window.

The option **Range** allows you to choose between automatic or manual adjustment of the temperature scaling within the diagram.

There are two possibilities of displaying the profile **Curve** in the profile diagram. Using the option **Assign to image** the profile curve fills only the parts corresponding with the actual length of the profile in the image. Using the option **Full range** the profile curve fills the whole profile diagram independent from the size of the profile.

Bind measure areas to profile ...

Range

Auto Min: 0,0 [°C]

Manual Max: 100,0 [°C]

Curve

Assign to image

Full range

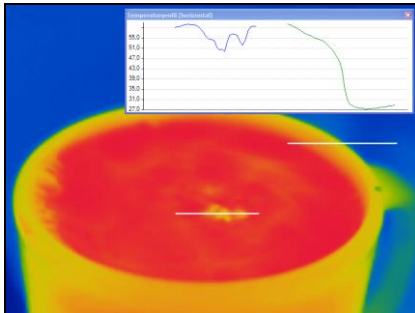

The profile curve assigned to the image
(Display in separate window)

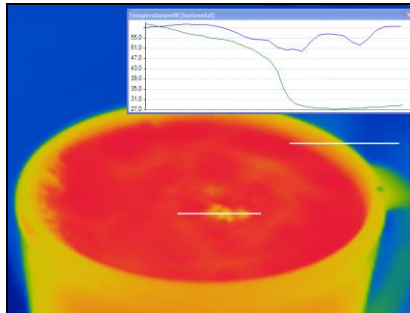

The profile curve assigned to the full
range of the diagram (Display in
separate window)

Use **Bind measure areas to profile** to assign various measure areas to a temperature profile. If the position of the profile is changed all the measure areas will also be moved. The respective profile can be chosen via the option **Assign measure areas to**.

Prefix for measure area name enables the individual labeling of measure areas. The measure area type can be defined under the **Mode** options.

Number of measure areas to create as well as the **Width [% of profile length]** and **Minimum height [pixels]** can also be specified.

Via the **Measure mode** you can determine the way of displaying the minimum, maximum or mean temperature in the digital display window (please see section 2.2.1).

"Bind to temperature profile" Wizard

Assign measure areas to: Temperature profile 1
 Temperature profile 2

Prefix for measure area name: T2

Mode: Measure point (3x3)

Number of measure areas to create: 5

Width [% of profile length]: 20.0

Minimum height [pixels]: 5

Measure mode:
 Minimum Mean value Maximum

Delete existing measure areas of this temperature profile

Create Cancel

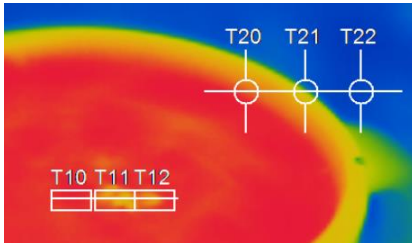

3 rectangles and 3 measure points are assigned to temperature profile 1 and 2.







The option **Delete existing measure areas of this temperature profile** eliminates the defined settings of a profile.

Save the settings by pressing the **Create** button.

4.3. Temperature Time Diagram

4.3.1. General settings

In the **Tools**, **Configuration** and **Temp/Time Diagram** menu you can display the temperature over time for each configured measure area as well as for predefined values (please also see **2.2.4**). The **Show** options define if a certain temperature value is displayed or not. If the **graph** is shown you can decide whether to illustrate the **name** or not.

Measure Area	Show		Auto range	Pen	
	graph	name		width	color
Area 1	<input checked="" type="checkbox"/>	<input checked="" type="checkbox"/>	<input checked="" type="checkbox"/>	2	
Chip	<input type="checkbox"/>	<input type="checkbox"/>	<input type="checkbox"/>	1	
Internal	<input type="checkbox"/>	<input type="checkbox"/>	<input type="checkbox"/>	1	
Reference	<input type="checkbox"/>	<input type="checkbox"/>	<input type="checkbox"/>	1	
<input type="checkbox"/> [All]:					
Value	<input type="checkbox"/>	<input type="checkbox"/>	<input type="checkbox"/>	1	 Range
Value	<input type="checkbox"/>	<input type="checkbox"/>	<input type="checkbox"/>	1	 Range

If activating the option **Auto range** the respective graph is influencing the auto ranging of the diagram. If the option is not chosen the scaling is based on the other temperature values. In the menu **Pen**, the **width** of the graph as well as its **color** can be individually configured.

A further option is to define the time scaling of the diagram at a minimum **[sec.]**. If activating **set initial time to fixed value** the time scale will be the length of the initial time chosen. When choosing **set initial time to length of video** the time scaling is adjusted to the length of the stored video sequence loaded into the software. With **set maximal time to length of video** the scaling of the time axis is fixed to the whole recording length.

Initial time:	While playing
<input type="text" value="10,0"/> [sec.]	<input checked="" type="radio"/> set initial time to fixed value
	<input type="radio"/> set initial time to length of video
	<input type="radio"/> set maximal time to length of video

In the **Diagram measuring settings** you can define the maximum of data (**Maximum data count**) which is displayed in the diagram. 1.000 x 1.000 results in 1.000.000 (one million) data values; the needed **Memory** will be calculated automatically. For demonstration purposes with many measuring fields in the diagram, you can make over the option **Initially data count**, an initial specification of the max. number of data counts (computer memory is reserved). Using the option **Auto (device framerate)**, the **Recording time** is calculated based on the frame rate of the camera (please also see 3.4.1).

Independent from the frame rate of the camera you can individually set the number of data. If you choose the option **User defined** you can put into the box **Diagram resolution** the rate of displayed data (time interval). Via the arrows the interval can be increased or decreased.

Diagram measuring settings

Diagram settings

Maximum data count 1000 x 1000

Initially data count as maximum 1000 x 1000

If max. data count reached

Stop Overwrite

Memory: Initially: 7,63 MB
Maximum: 7,63 MB

Diagram resolution: 10,417 msec

Auto (device framerate) User defined

Recording time: 2h, 53min

Note: Re-played video sequences dont use the settings of this dialog.

OK Cancel



Temperature time diagram
Software tutorial
<https://www.optris.global/temperature-time-diagram>

4.3.2. Scaling of diagram axes

Control elements of the time axis

- 1 Scroll bar to choose time segment.
- 2 Zoom (increase) into the diagram.
The temperature axis will remain.
- 3 Zoom (decrease) into the diagram.
The temperature axis will remain.
- 4 Whole range: Display of whole time axis, e.g. of a stored video sequence.
- 5 H: Hold/ C: Continue:



Any activation of the **H** control element will stop the further actualization of the measurement graph. The measurement itself continues in the background. To return to the current measurement graph please press the **C** control element.

During the stopped status any parts of the diagram can be selected. With the zoom in-button + these parts can be stretched (enlarged) and with the zoom out-button – clinched (minimized).

Control elements of the temperature axis

- 6 Global scaling: The temperature range of the diagram will automatically be adapted to the respective peak values. The range will remain as set during the whole measurement.
- 7 Local scaling: The temperature range of the diagram will be adapted dynamically to the respective peak values. After the respective peak has left the diagram in the further process of the measurement, the

range will be readapted. This option enables an optimum display of the temperature graph.

- 8 Scroll bar to choose temperature segment.
- 9 Zoom (increase) into the diagram. The time axis will remain.
- 10 Zoom (decrease) into the diagram. The time axis will remain.
- 11 Whole range: Display of whole temperature range which is set in the camera.

4.4. Histogram

The Histogram feature shows the distribution of pixel intensity values within a thermal image. The X-axis of the histogram represents the pixel intensity and the Y-axis represents the percent of color count for each pixel intensity value.

In the **Tools**, **Configuration** and **Histogram** menu you can adjust various settings. The given **Temperature range** and **Temperature distribution** can be generated by the software or by the user by defining the minimum/maximum temperature range respectively minimum/maximum temperature distribution.

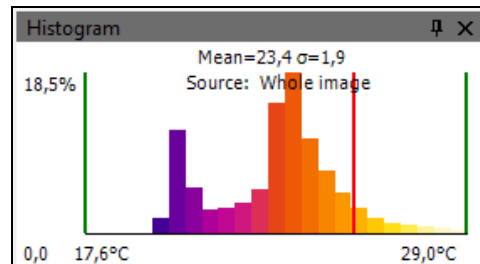

<p>Temperature range (x-axis)</p> <p><input checked="" type="radio"/> Auto</p> <p><input type="radio"/> Manual</p> <p>Min: <input type="text" value="0"/> [°C]</p> <p>Max: <input type="text" value="100"/> [°C]</p>	<p>Temperature distribution (y-axis)</p> <p><input checked="" type="radio"/> Auto</p> <p><input type="radio"/> Manual</p> <p>Min: <input type="text" value="0,0"/> [%]</p> <p>Max: <input type="text" value="100,0"/> [%]</p>	<p>General</p> <p>Display</p> <p><input checked="" type="checkbox"/> Current temperature</p> <p><input checked="" type="checkbox"/> Mean and sigma value</p> <p><input checked="" type="checkbox"/> Source</p> <p><input checked="" type="checkbox"/> Values (if enough space)</p> <p><input checked="" type="checkbox"/> Use palette colors</p> <p>Step size: <input type="text" value="0,5"/> [°C]</p>
<p>Source</p> <p><input checked="" type="radio"/> Whole image</p> <p><input type="radio"/> Measuring area: <input type="text" value="Bereich 1"/></p>		

Further options are:

Current temperature	If activated the red line will show the current temperature at the mouse in the graph.
Mean and sigma value	Average temperature and statistical deviation 1σ (1 Sigma) will be displayed.
Source	Shows on what source the histogram is related to.
Values	The current values of the single palette colors are shown, but it needs a certain window size to illustrate them on the graph.
Use palette colors	You can choose between colored or black/white presentation.

Step size	Shows the width of the bar in °C or °F.
------------------	---

Under **Source** can be decided whether the histogram should refer to the **whole image** or to a specific selected **measuring area**.

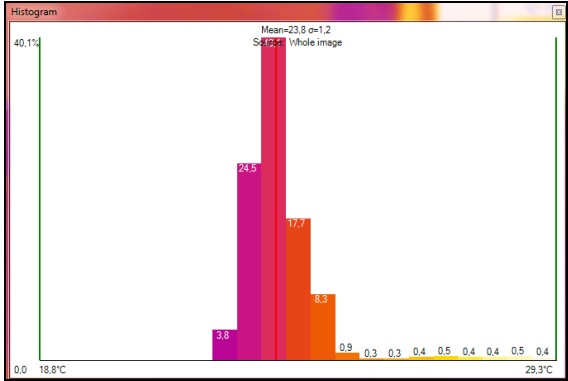

Histogram with the view of current temperature, mean and sigma values, Source, Values, Use palette colors and step size (here: 0,5°C)

4.5. Extended measuring colors

The **Tools**, **Configuration**, **Measuring colors** and **Extended Measuring colors** menus offer you the possibility to change the pixel color within the image if the temperature **Range** reaches predefined low and/or high temperature values. Doing this you can visualize temperature gradients. Furthermore, the display of isotherms (colored display of temperature group) is possible.

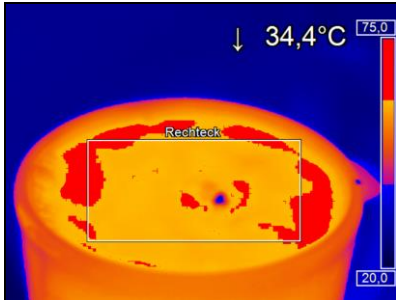

Extended measuring colors		
Range	Threshold	Mode
High:	30,0 [°C]	<input type="radio"/> Off <input checked="" type="radio"/> Color <input type="radio"/> Alt. Palette <input type="radio"/> Ext. Alt. Palette
Mid:	20,0 [°C]	<input checked="" type="radio"/> Off <input type="radio"/> Color <input type="radio"/> Alt. Palette <input type="radio"/> Ext. Alt. Palette
Low:		<input type="radio"/> Off <input type="radio"/> Color <input type="radio"/> Alt. Palette <input checked="" type="radio"/> Ext. Alt. Palette

Visual indicators: A red bar is shown next to the 'High' section, and a blue bar is shown next to the 'Low' section. A dropdown menu for 'Low' is set to 'Alarm Blue'.

Two temperature limits can be defined via **Threshold** value. The individual display of the pixels at the top (**High**), in the middle (**Mid**) of the temperature limits and at the bottom (**Low**) can be done by a certain color (isotherm) or a certain color palette. Using **Alt. palette** the colors correspond to the temperature borders in the reference bar option. You will see the range of the palette which was defined by the thresholds. With **Ext. Alt. Palette** you can individually define the start and end point of the extended alternative color palette within the overall reference bar.

4.6. Image subtraction



Once you have activated the feature by using **Image subtraction** in the **Tools** and **Extended** menu or via the **Icon** on the toolbar (which must be added manually), an image is saved in the background and a temperature difference is calculated and displayed for all the following images.

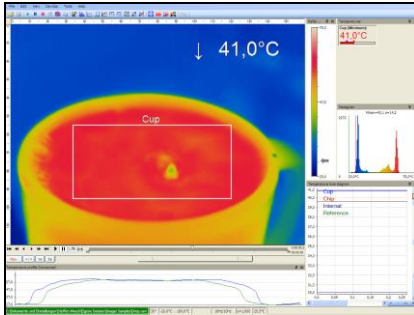
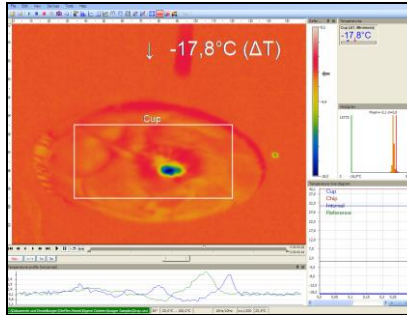

Image subtraction is not activated. The current averaged temperature of the measure area is displayed in the right top corner.



After activating the image subtraction function the current temperature difference compared to the previous image is displayed.



Alternatively, you can load a previously saved radiometric image (TIFF) using **Image subtraction from file** in the **Tools** and **Extended** menu or via the **Icon** on the toolbar in order to use it as a template for the image subtraction.

Under Menu **Tools**, **Configuration** and **Extended Layout** you can choose by **Image subtraction – On loading layout do** between **Keep existing image subtraction**, **Reset existing image subtraction** and **Load this image file**.

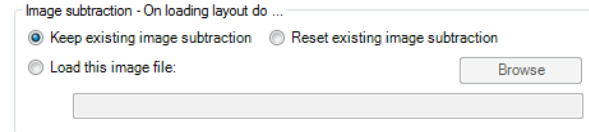

4.7. Relative extreme values

Within the **Tools**, **Configuration** and **Extended measuring** menu it is possible to exclude pixel within the thermal image from data analysis.

Using **Ignore pixels with temperatures** a temperature can be set as lowest (**below**) or highest (**above**) value.



In case of analyzing an image using measure areas (**for measure areas**) the calculation of e.g. the mean value is not taking values below or above the set limits into account.

For hot/cold spots localization determines that all pixels with the defined values are excluded from search.

For </> temperature ranging means that all pixels with the respective temperature do not influence e.g. the automatic scaling of temperature-time-diagram.

4.8. Alarms

Alarm

In the **Tools**, **Configuration** and **Alarms** menu you can define an alarm and pre-alarm for each configured measure area as well as for the predefined values (please also see **2.2.4**). Pre-alarms can be useful as an advance warning.

Measure area	Display ranges		Pre-alarms		Alarms		GraphBar	Alarm Appl.	Alarm to PIF
	Min.	Max.	Low	High	Low	High			
Area 1	0,0	100,0	24,0	36,0	20,0	40,0	<input checked="" type="checkbox"/>	<input checked="" type="checkbox"/>	<input type="checkbox"/>
Cursor	0,0	100,0	24,0	36,0	20,0	40,0	<input checked="" type="checkbox"/>	<input type="checkbox"/>	<input type="checkbox"/>
Chip	0,0	60,0	<input checked="" type="checkbox"/>	10,0	50,0	5,0	55,0	<input checked="" type="checkbox"/>	<input type="checkbox"/>
Internal	0,0	60,0	<input checked="" type="checkbox"/>	10,0	40,0	5,0	45,0	<input checked="" type="checkbox"/>	<input type="checkbox"/>
Reference	0,0	100,0	<input type="checkbox"/>	24,0	36,0	20,0	40,0	<input checked="" type="checkbox"/>	<input type="checkbox"/>
[All]:	<input type="checkbox"/>								
Value	0,0	100,0	24,0	36,0	20,0	40,0	<input checked="" type="checkbox"/>	<input type="checkbox"/>	<input type="checkbox"/>

The alarm values can be displayed as figures in the digital display or in a graphical way as a bar. For the latter you need to activate the option **GraphBar**. Regarding the bar you can define via **Display ranges** the **Min.** and **Max.** value (temperature borders). With **Alarms** the **Low** and **High** thresholds can be set which finally defines the displayed color. If the high alarm value is reached or exceeded the color of bar changes to **red**, for pre-alarm **orange**. If the measured temperature reaches or goes below the lower alarm value the color of bar changes to **blue**, for pre-alarm **light blue**. Temperatures in between the defined thresholds are displayed **green**.

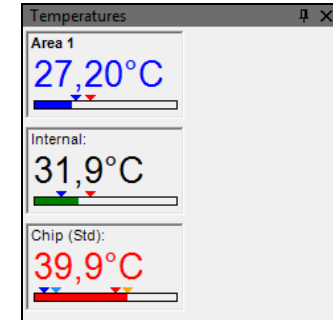

Note

The background color of the window for the digital display of the main measuring field also changes when the alarm value is below or exceeded, in **light blue** or **blue** (low alarm) or **orange** or **red** (high alarm).

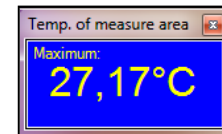

If a temperature value shall be used as an pre-alarm, you need to tag the **Pre-alarms** option. The alarm can also be put out via the Process Interface (PIF) using the **Alarm to PIF** option.

Note



If activating the **Alarm Appl.**, a red alarm button on the toolbar appears. You can deactivate the visual and acoustic alarm by clicking on the alarm button. The alarm will stay deactivate until the alarm value is reached again.



In the **Alarm configuration** window you can set an **Audible alarm**.

In the **Interval [sec]** input box you can specify the time interval the sound appears.

Via the **Path to sound file** you can **Browse** an individual *.wav file

The acoustic alarm signalization can be repeated in defined intervals setting the **Interval [sec]**.

Using the option **Recording on alarm** you can specify a **Delay [sec]**. The recording starts after the delay time is over. In the **Duration [sec]** box the recording time of the video sequence can be set (max. 86400 seconds = 24 hours).

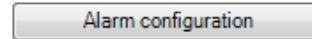

Audible alarm

Enable

Interval [sec]: 5

Path to sound file: C:\Windows\Media\ding.wav

Browse

Recording on alarm

Enable

Delay [sec]: 10

Duration [sec]: 10

Abort recording if alarm condition drops out

Furthermore, a recording can be stopped via **Abort recording if alarm condition drops out**. If this option is not chosen the recording will be finished based on the time in the duration box.

With the **Snapshot on alarm** option it can be determined whether a snapshot of the thermal image should be taken in case of an alarm condition.

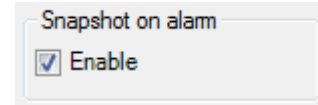

4.9. 3D display of thermal image

Thermal images can be displayed in real time as 3 dimensional images. The 3D Chart is displayed in a separate window. To add the software window please use the menu item **View**, **Windows** and **3D Chart** or the **Icon** on the toolbar

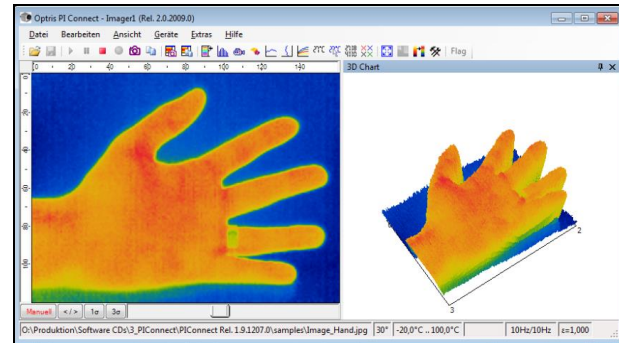

4.10. Event grabber

Batch processes are easy to handle thanks to the event grabber. In the case of fast-paced recurring processes, a snapshot is created when an alarm condition occurs, in order to be able to analyze critical areas.

The settings can be found under the menu **Tools**, **Configuration** and **Event grabber**.

Under **Trigger mode** you can select between **Self-triggered (on alarm of a measure area)** and **External triggered (on PIF)**.

In the case of **Self-triggered (on alarm of a measure area)**, the event is triggered by the set application alarm. At first the **Triggering measure area** has to be selected at which the set alarm condition is to be triggered.

At **External triggered (on PIF)**, the event is triggered by the process interface (PIF). For this, a **Trigger input** must first be selected. The available inputs depend on the PIF which is used.

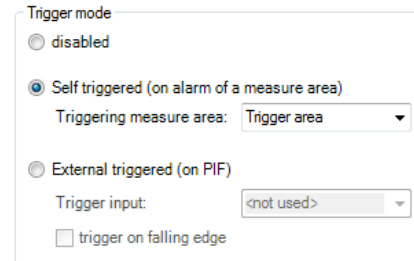
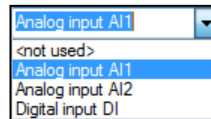

On trigger hold, the following items can be selected:

- **3D Chart:** The 3D diagram is held in case of an alarm condition.
- **Temperature Time Diagram:** The Temperature Time Diagram is held in case of an alarm condition.
- **Temperature Profile:** The Temperature Profiles are held in case of

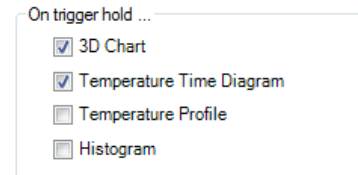

an alarm condition.

- **Histogram:** The Histogram is held in case of an alarm condition.

Under **Extended settings**, a **Holdoff time** can be entered. A new alarm condition is not taken into account during this set time.

If the checkmark is enabled by **Allow event grabbing (and alarm) while playing**, the event grabber is considered when playing a Ravi.

Create snapshot on event will create a snapshot after every event which will appear in the snapshot history and in the event grabber (frozen image) window.

The triggered snapshot for the event grabber can be found under menu **View**, **Windows** and **Event grabber (frozen Image)**.

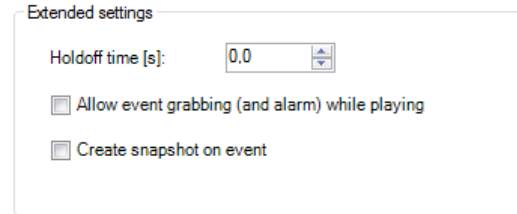

Extended settings

Holdoff time [s]: 0.0

Allow event grabbing (and alarm) while playing

Create snapshot on event

Measurement areas can be created and arranged in the live IR image as well as in the event grabber (frozen image). If you want to add an measurement area in the event grabber (frozen image), this must be set under the **Configuration** menu and **Measure areas**. Under **Measure area**, the check mark **Use in event grabber** must be selected.

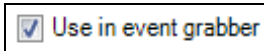

As a template for the event grabber, you can use the sample layout **Event grabber**.



Event grabber
Training Videos

<https://www.optris.global/ir-temperature-measuring-on-moving-plastic-parts-during-a-preform-production-event-grabber>

4.11. Zoom function of snapshots

Captured snapshots can be enlarged when viewed. To do this, open a saved snapshot (TIFF file), as described in chapter 3.1. Use **+** to zoom in and **-** to zoom out or use the bars on the side.

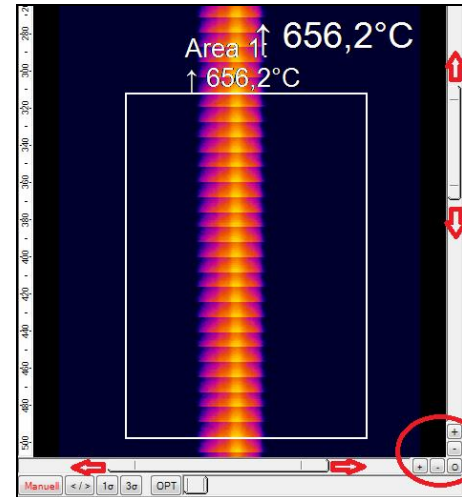

5. Xi camera

5.1. Focus setting

The special feature of the Xi camera is the motorized focus adjustment. This can be found under menu **View**, **Windows** and **Distance**. Here you can change the position of the focus by moving the gray slider. With the arrow keys you can also change the position in different stages. An adjustment to the left leads to the focus setting "near" and an adjustment to the right to the focus setting "infinite".

The **focus motor position** can be saved either in the **Device** or in the **Layout**. This setting is located in the configuration menu under the **Device** tab.

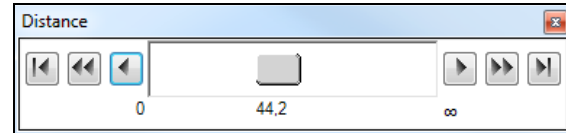

Focus motor position

Priority: Device Layout

5.2. Imager interfaces for Xi 80/410



Note

Imager interfaces for Xi 400, please see chapter 2.5

5.2.1. General

The Xi 80/410 has a direct analog input (AI) / digital input (DI) for camera control and a direct analog output (AO) for process control. These can be connected to the supplied terminal block. In addition, there is an RS485 interface. When using the RS485 interface, the direct outputs and inputs are not available. The signal level is 0-10 V for AI and 0/4-20 mA for AO. The interfaces can be set up by the software with the following functionality:



Analog Input (AI): Emissivity, Ambient temperature, Reference temperature, Uncommitted value, Flag Control, Triggered Snapshots, Triggered Recording, Triggered Linescanner, Triggered event grabber, Reset Peak-/Valley-Hold, Switch temperature range

Analog Output (AO): Main measure area, Measure area, Internal temperature, Flag Status, Recording Status, Line scan status, Alarm, Frame sync, Fail-safe, External Communication

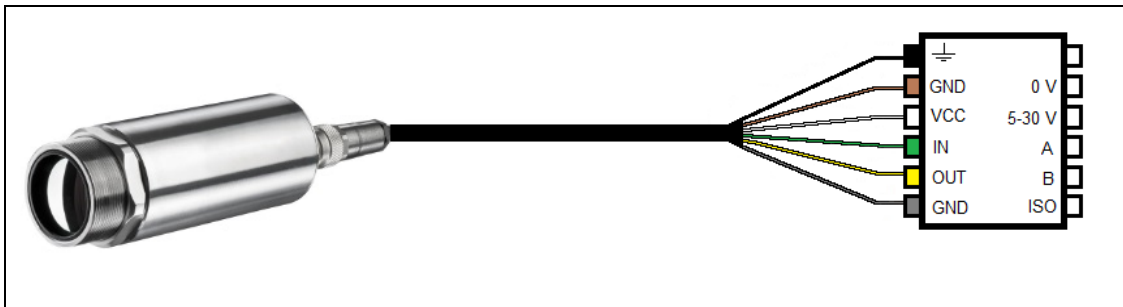

Configuration Process Interface (PIF)

5.2.2. Process interface (PIF)

Using **Tools**, **Configuration** and **Device PIF** menu you can configure a PIF which is connected to the camera. The number of in- and outputs can vary depending on the connected **PIF type** (internal PIF or stackable PIF). An available in- or output will be marked with a green checkmark (✓). A not available in- or output will be marked with a red ✗. With **Show all available in-/outputs**, only the available inputs/outputs are displayed.

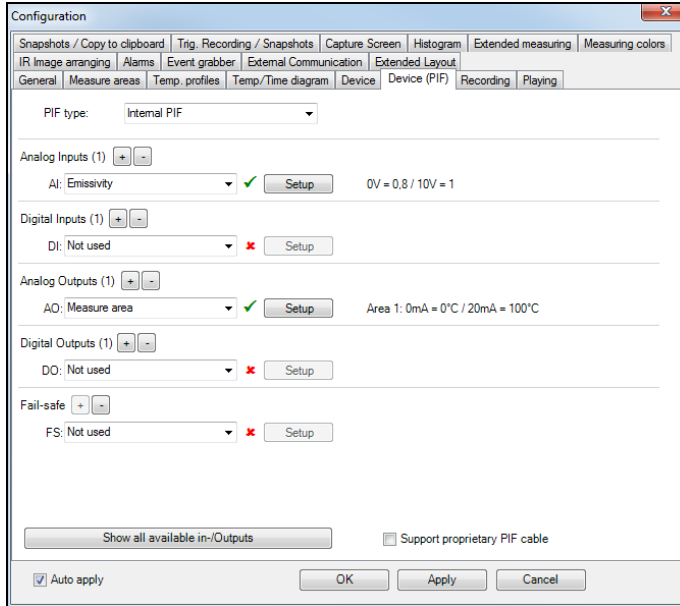

If you configure an analog value an additional window will show up if you press the **Setup** button. In this window you can scale the in- or output:

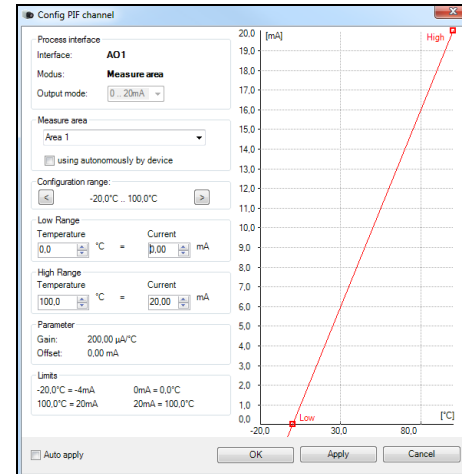

On the analog inputs you can select each function only once (exception: Uncommitted value).
On the analog outputs also each function can only be selected once (exception: Measurement area; Alarm).

The settings for the stackable PIF are similar to those for the internal PIF. Under **PIF type**, **Stackable PIF** must first be selected. Furthermore, the number of PIFs used must be specified under **Devices**. The device number must be identical to the RS485 address set on the device. Now the existing inputs and outputs can be assigned with corresponding functions.

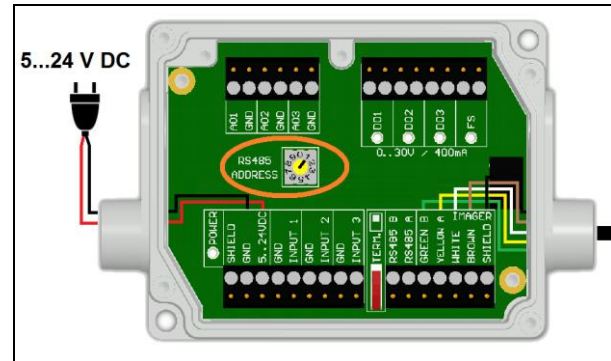
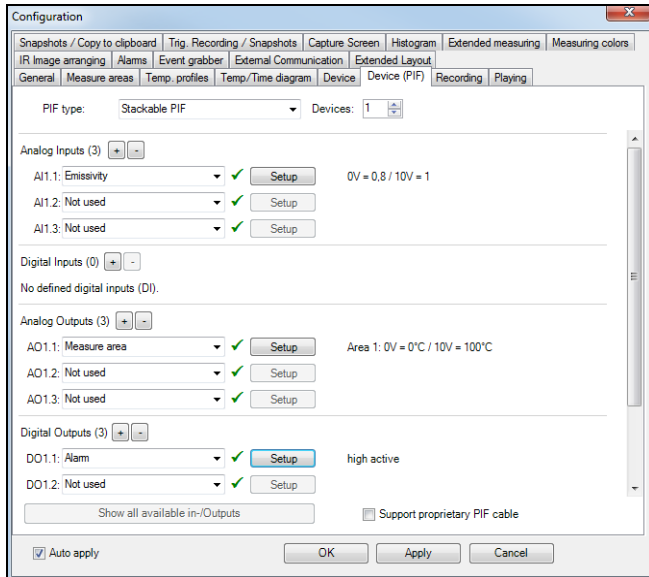

The numbering of the individual inputs and outputs is structured as follows: The first number refers to the device and the second to the port (for example AI2.3: Analog input from PIF No. 2 and Port No. 3).



Note

You can use the analog inputs, outputs and the digital input of the PIF simultaneously.

Measure area	Display ranges		<input type="checkbox"/>	Pre-alarms		Alarms		GraphBar	Alarm to PIF
	Min.	Max.		Low	High	Low	High		
Area 1	0,0	100,0	<input type="checkbox"/>	24,0	36,0	20,0	40,0	<input checked="" type="checkbox"/>	<input checked="" type="checkbox"/> AO1
Area 2	0,0	100,0	<input type="checkbox"/>	24,0	36,0	20,0	40,0	<input checked="" type="checkbox"/>	<input checked="" type="checkbox"/> AO2
Area 3	0,0	100,0	<input type="checkbox"/>	24,0	36,0	20,0	40,0	<input checked="" type="checkbox"/>	<input checked="" type="checkbox"/> AO3

[All]:

If you activate the function **Alarm** on an analog output you need to assign also in the **Alarms** tab the desired measurement area to the desired PIF output.

The industrial PIF has a maximum of three analog outputs. To use more outputs, you can cascade up to three PIFs, allowing you to use up to 9 analog or alarm outputs in total.

For more information on the settings for alarms, see section **4.8 Alarms**.

The process interface has an integrated fail-safe mode. This allows to control conditions like interruption of cables, shut-down of the software etc. and to give out these conditions as an alarm. The time constant of the fail-safe is 1.5 seconds.

Controlled conditions on camera and software	Standard Process interface ACXIPIF	Industrial Process interface ACXIPIFCBxx
Interruption USB cable to camera	✓	✓
Interruption data cable camera – PIF	✓	✓
Interruption power supply PIF	✓	✓
Shut-down of software	✓	✓
Crash of software	-	✓
Fail-Safe output	0 mA at analog output (AO)	Open contact (Fail-safe relay) / red LED on

The failsafe function can be activated in the tab **Device (PIF)** under **FS**. The industrial PIF has a separate failsafe relay.

Alternatively you can activate this function also on the analog outputs. The checkbox **Stop fail-safe pulse on alarm** must be activated, if the analog output should be used in addition as an alarm output for a temperature alarm. In case of an alarm the alternating fail-safe pulse signal will stop and the set voltage level will be given out as constant value (stackable PIF only).

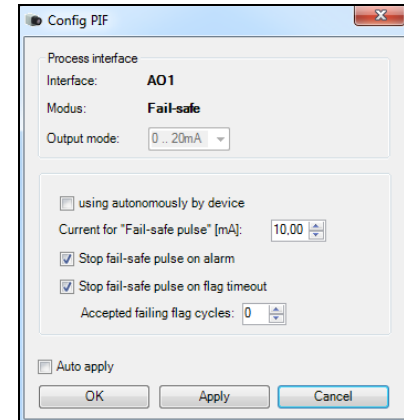

5.3. Ethernet Xi 80/410

The Xi 80/410 has a direct Ethernet interface. Using the Ethernet connection, the device must be supplied with power (see Xi manual).

5.3.1. Ethernet setup (Point-to-Point-Connection)

Before you can make the settings in the software, you must first configure the network settings on the PC.

Note



The devices are delivered with the following factory settings:

- **IP address camera: 192.168.0.101**
 - **IP address PC: 192.168.0.100**
 - **Port number: 50101**
-

To do this, go to **Control Panel** and open the **Network and Sharing Center**. Go on **Ethernet**.

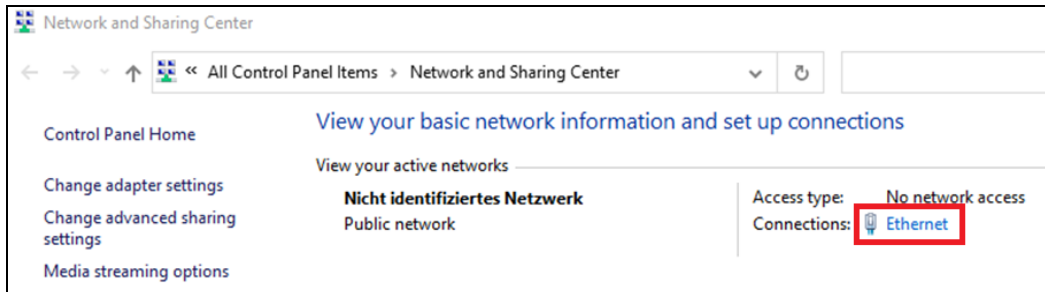

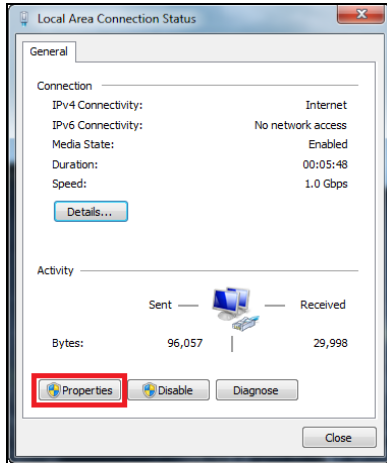

Click on **Properties**.

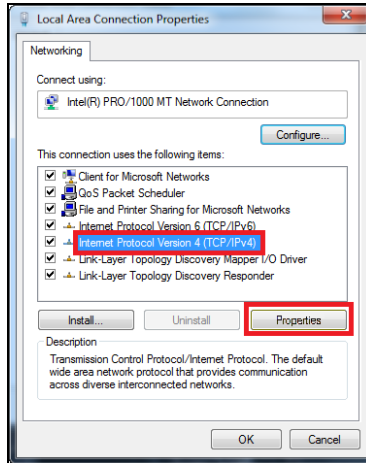

Mark **Internet protocol Version 4 (TCP/IPv4)** and go to **Properties** again

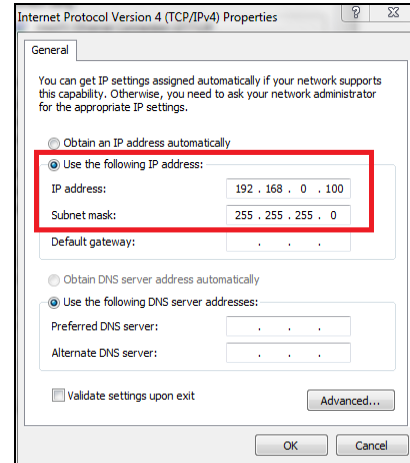

In the register card **General** enable the checkbox **Use the following IP address**. Now enter a user defined IP address for your PC (192.168.0.100). This must be identical to the address set in the PIX Connect software.

Then close all windows with OK. The network settings on the PC are complete.

Now start the PIX Connect software and activate the Ethernet function. To do this, go to the menu **Devices** and **Enable Ethernet**.

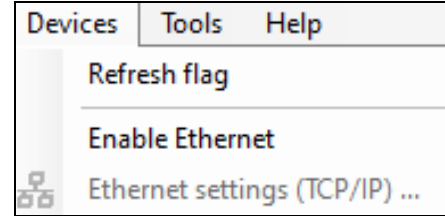

Note

Make sure that all three networks (Domain, Private, Public) are allowed in the Windows Firewall window to ensure a connection to the device

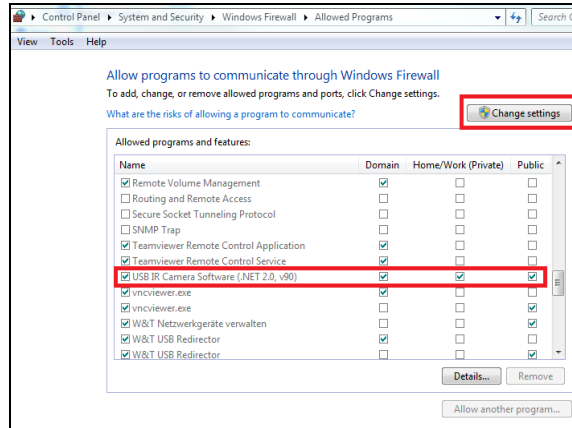
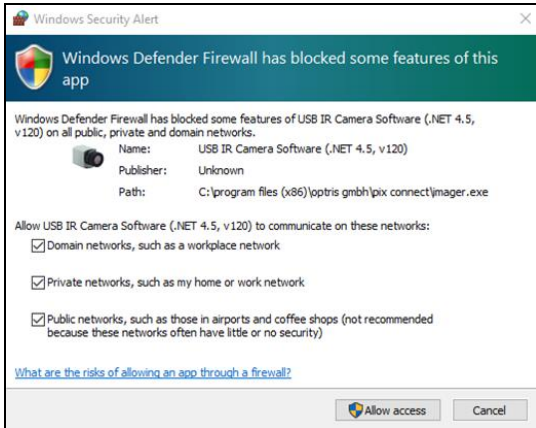



Note

The approval of programs can also be activated afterwards in the Windows Firewall settings of the PC (under *Windows Firewall* and *Allow a program or feature through Windows Firewall*).

The device is now ready for the Ethernet connection and is listed in the menu under **Devices**. The camera is identified by a network icon and the network address and port number. Select the device. A connection to the device is established and the temperature measurement can begin.

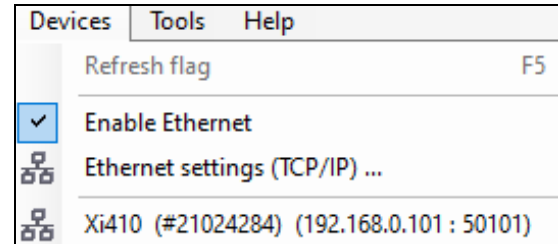

To change the address settings, go to **Device** and **Ethernet Settings (TCP/IP) Settings**. The device is set up via the USB connection of the camera.

The address for the device is assigned under **Device address**. This must have a different address (last block) to the other participant (e.g. PC) (**Send to address**). It is important that the network part (first three blocks) must be identical for both addresses. The address range of the individual blocks can be between 0 and 255.

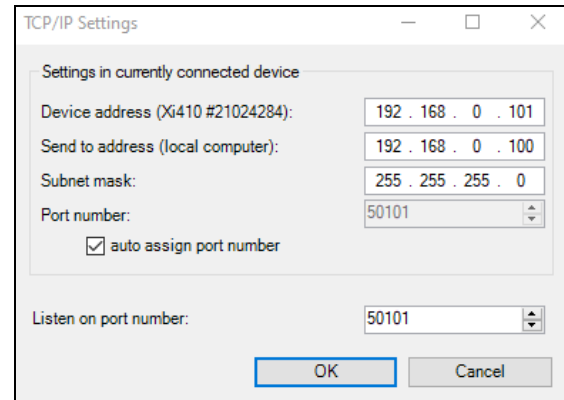

Additionally, a separate **port number** must be configured. The selected number can be between 1 and 65535.

The **auto assign port number** option automatically assigns a port number.

If several cameras with different port numbers are connected and a specific camera is to be communicated with, the corresponding camera can be determined via **Listen on port number**.

5.4. Autonomous operation Xi 80/410

A special feature of the Xi 80/410 is the autonomous operation. There is no need for a permanent connection to the PIX Connect software. Only a few settings must be set in advance in the software.

Proceed as described in chapter **5.2.2**. Select an output with corresponding function and press **Setup**. Here you must put the check in **using autonomously by device**.

A @ sign will appear next to the output used in the configuration menu Device (PIF). Whenever this sign is visible, the function can run in autonomous operation.



Analog Outputs (1) + -

AO: Measure area ✓ Setup

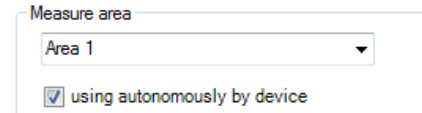

Measure area

Area 1

using autonomously by device



Analog Outputs (1) + -

AO: Measure area ✓ Setup @ Area 1: 0mA = 0°C / 20mA = 100°C

Note

If a hot- or coldspot is to be output in autonomous operation, this does not work by activating the spots. A **user defined rectangle** must be selected under the tab **measure areas** of the configuration dialog. In addition, under **Mode**, you must set whether the **maximum** (for hotspot) or **minimum** (for coldspot) should be output. For a hot- or coldspot output in the full field of view of the camera, the user defined rectangle must also fill out this size.



Measure area	
Name:	Area 1
Shape:	User def. rectangle ▼
Mode:	Maximum ▼

When using the Xi 410 camera, an important additional setting must be made for autonomous operation. When all the configurations have been made, it is important to write them to the device. This is done in the menu under *Devices* and *Set configuration to device*.

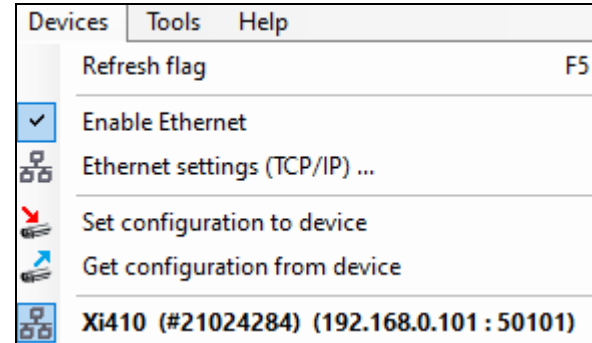
If the device is reconnected to a PC after autonomous operation and the settings are to be transferred from the device to the software, this is done in the menu under *Devices* and *Get configuration from device*.



Note

An arrow marked in red  means that the configuration is different between the camera and the software. As soon as the configuration is loaded into the device, the arrow appears blue .

Reconnection to PC with Xi 80

When the unit is reconnected to a PC with the PIX Connect software after autonomous operation and the layout or settings differ between the unit and the software, an information window appears with the following options:

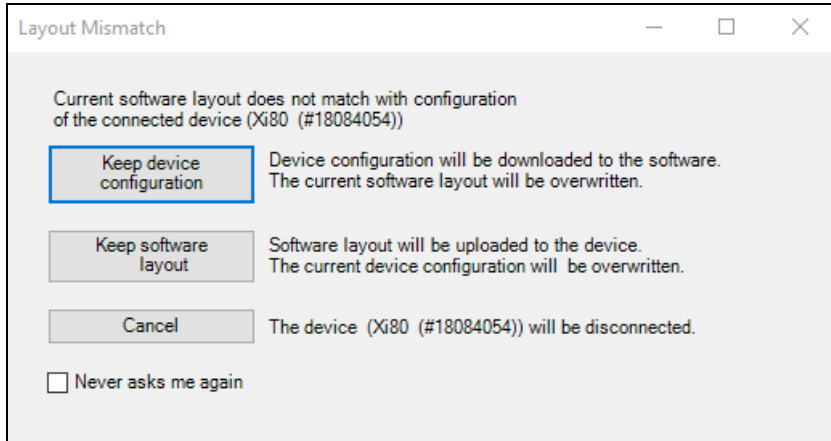

Keep device configuration	Device configuration will be downloaded to the software. The current software layout will be overwritten.
Keep software layout	Software layout will be updated to the device. The current device configuration will be overwritten.
Cancel	The device (xx (#xxxxxxx)) will be disconnected.

This prevents the set layout from being overwritten on the device.

Reconnection to PC with Xi 410

When using the Xi 410, the settings must be transferred manually from the device to the PC if desired. To do this, go to the menu under *Devices* and press *Get configuration from device*.

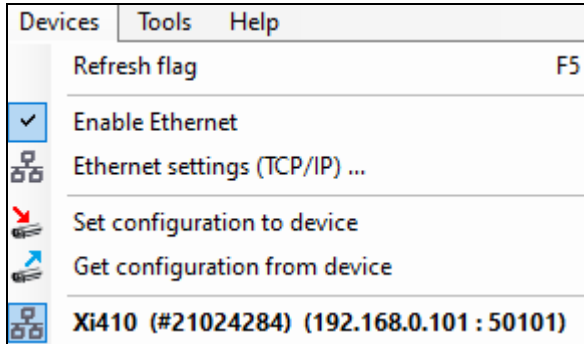

Note



An arrow marked in red  means that the configuration is different between the camera and the software. As soon as the configuration is loaded from the device to the PC, the arrow appears blue



6. Line scanner mode

6.1. General information

The PIX Connect software comes with a line scanner function. The line scanner mode is generally used for continuous processes with moving objects under test, such as measurement of rotary kilns or measurement of great lots at conveyor belts (batch process).

Overview of the advantages:

- ① Simple monitoring of process with limited optical access
- ② Indirect visualization of heat distribution within ovens via camera installation at the oven exit
- ③ Extension of number of pixel through the use of the picture diagonal (e.g. PI 640)
- ④ Very fast data recording of unlimited lines which-in turn can produce thermal images of any resolution
- ⑤ Huge FOV as a line for detailed process analysis such as at wide conveyor belts (e.g. PI 640 with an 90° optic)

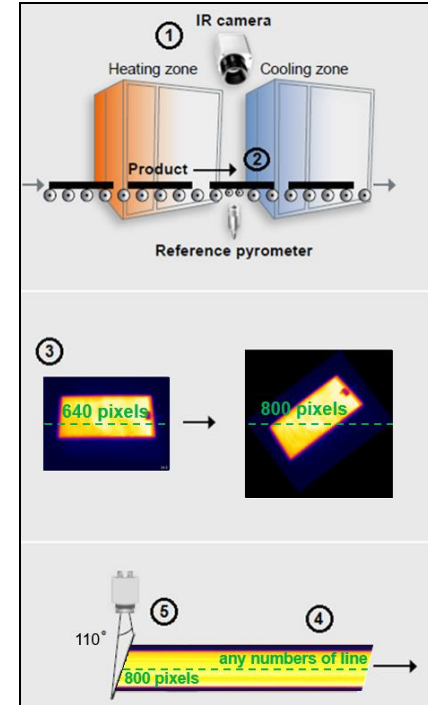

6.2. Basic settings

6.2.1. Line scanner configuration menu



All the settings related to the line scanner mode can be done through the **Line scanner configuration** menu. You will find the menu under **Tools**, **Line scanner mode** and **Line scanner settings** or as an **Icon** on the tool bar.

6.2.2. Choosing the layout

Before you configure the Line scanner mode a suitable layout (e.g. alignment of application windows) should be chosen or created. You will find more details in chapter 2.2.

6.2.3. Rotating of the image

For some application is it of advantage to increase the number of pixels per line by changing the view angle. To do so go to **Rotate** menu (see chapter 2.3.2).

According to the chosen angle the camera has to be mounted under defined angle, too.

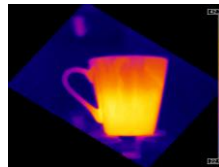
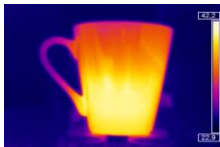
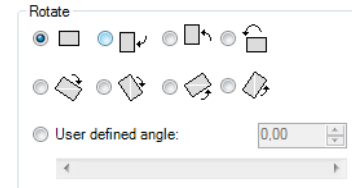

6.2.4. Activating the Line scanner



In order to configure the Line scanner it is necessary to activate the Line scanner mode under **Tools**, **Line scanner mode** and **Enable Linescanner** or using the **Icon** on the tool bar.

Note



There are two view options available under Line scanner mode. **Line scanner sighting view** is showing the position of the line and self-trigger area within the infrared image taken by the camera. **Line scanner view** delivers the resulting infrared image based on temperature readings for selected lines.

6.2.5. Positioning of the line (Line scanner sighting view)



The pre-defined position of the line can be seen in the Line scanner sighting view. To access the view go to **Tools**, **Line scanner mode** and **Line scanner sighting view** or use the **Icon** provided.



Note

This icon enables to switch between Line scanner sighting view and Line scanner view.

To define the position of the line within the infrared image, go to **Line scanner configuration** application window (see 6.2.1) in the **Source** menu. In the **Lines taken from source** section using **First row** and **Last row** field you can specify how many lines are to be considered during the measurement. Number 1 stands for the first line from the top in the infrared image.

Lines taken from source

First row:	<input type="text" value="10"/>
Last row:	<input type="text" value="10"/>

If more than one line should be taken from the source the **Direction** menu enables to choose the direction in which they will be measured and consequently displayed in **Line scanner sighting view** mode.

The option **Scan on user defined line** makes it possible to graphically position the scan line through the mouse. It can also be entered by the coordinates (X and Y) in the **Start point (P1)** and **End point (P2)** fields. The number of pixels on the scan line and the angle are displayed in the field **linescanner pixels** and **linescanner angle**.

In addition to the start and end point, additional points can be added under **Add**, allowing complex lines to be created. **Lines** or **Splines** can be used.

Direction

- Scan on user defined line
- Scan top-down (rows)
- Scan bottom-up (rows)
- Scan left to right (columns)
- Scan right to left (columns)
- Scan on auto detected horizontal slit
- Scan on auto detected vertical slit

Points of user defined line

X: Y:

Start point (P1): 0 0

End point (P2): 159 119

Auxillary points: 0 0

Add

Remove

Mode: Lines Splines

linescanner pixels: 200

linescanner angle:

P3: [39, 29]
P4: [79, 59]

In the **Scan on user defined line**, individual points are moved by drag-n-drop.

The entire scan line is moved by touching a point with the Ctrl key pressed at the same time.

A rotation is reached when first a point is selected with simultaneous pressing the Alt key (this is the pivot point) and then a second point is drawn to rotate the line.

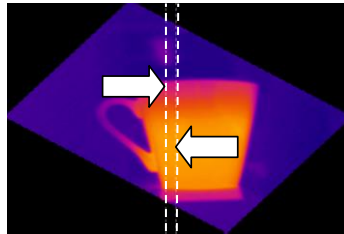
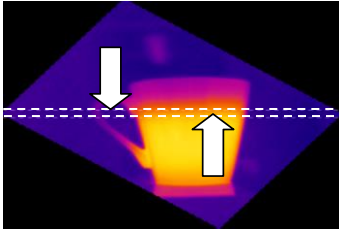

The displayed line scanner sighting views visualize the four possibilities how to capture and finally represent multiple lines in the line scanner view

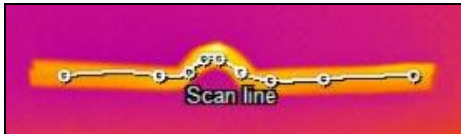

Scan line with multiple points as spline

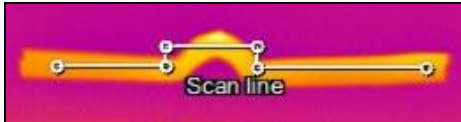

Scan line with multiple points as lines



Rotation of the scan line around a pivot point

The other options you can choose from are **Scan top-down (rows)** where the lines are measured and displayed from the top to the bottom, **Scan bottom-up (rows)** from bottom to top, **Scan left to right (columns)** from left to right and **Scan right to left (columns)** from right to left.

In all direction variants the scan line can be moved by mouse.

Direction **Scan on auto detected horizontal slit**: With this function the horizontal slit is automatically detected.

Direction **Scan on auto detected vertical slit**: With this function, the vertical slit is automatically detected.

When using the automatic slit function, a temperature must first be defined from when this function is to be active. This temperature can be **above** or **below** a certain limit.

The current width is displayed under **Slit width [pixel]** in the **Current average width** field. With **Min/Max** you can also define the minimum and maximum slit width.

The screenshot shows two panels. The left panel, titled 'Direction', contains a list of radio button options: 'Scan on user defined line', 'Scan top-down (rows)', 'Scan bottom-up (rows)', 'Scan left to right (columns)', 'Scan right to left (columns)', 'Scan on auto detected horizontal slit' (which is selected), and 'Scan on auto detected vertical slit'. The right panel, titled 'Auto detect line within slit', contains a 'Detect' section with 'above' selected and a temperature input field set to '100.0 °C'. Below this is a 'Slit width [pixel]' section with a 'Current avg. width' field set to '0,0' and 'Min / Max' fields set to '1' and '20'. A 'Slit location' section has a 'Limit to:' field set to '10' and '10'. At the bottom of the right panel are buttons for 'Create user defined line', 'Reset', and a checkbox for 'Auto adjust IR rotation'.

There is also the possibility to **limit** the location of the slot. To do this, the function must be activated and the range must be defined.

If the option **Auto adjust IR rotation** is activated, the image is automatically rotated vertically or horizontally based on the slit.

6.2.6. Layout configuration of the Sighting view mode

You can make further modifications to the Sighting view mode using **Tools**, **Line scanner mode** and **Line scanner settings**. If you go to **Sighting view** you can define several modifications.

The option **Show source scanning lines** enables you to fade the scanning lines in and out.

With **Show self triggering area** the self triggered area can be faded in and out.

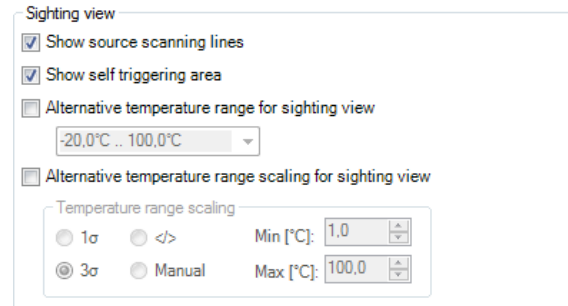

Alternative temperature range for sighting view option enables switching to temperature range different from the one used for the measurement. It is sometimes helpful to configure the line scanner when process is stopped using one temperature range where as different temperature range is defined to examine running process.

As a further option **Alternative temperature range scaling for sighting view** you can set up your own temperature range scaling.

6.3. Data evaluation of the scanned line

6.3.1. Line scanner view



In the line scanner view readings will displayed as an infrared image. To activate this view mode you can use the icon provided.



Note

This icon enables to switch between Line scanner sighting view and Line scanner view.

Presentation of the scanned lines can be further defined in **Line scanner configuration** application window (see 6.2.1) under **Presentation**. **Direction** option defines in which direction the scanned lines will be displayed. Scanned lines can be displayed as **Top-down**, **Bottom-up**, **Left to right** or **Right to left**.

If the line scan has been set up mirror-inverted, activating the **Mirror line** option will mirror the display and it will not be necessary to set it up again.

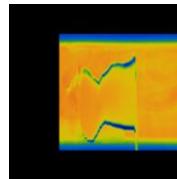
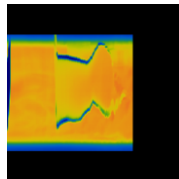
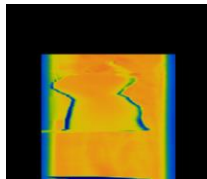
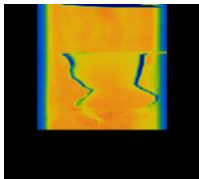
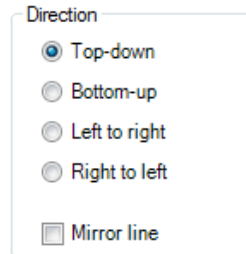

Presentation of scanned lines in the Line scanner view:
Top-down,
Bottom-up,
Left to right and
Right to left.

Under **Presentation**, two different options can be selected under **Mode**: **Length/Width** and **Linecount**. The **Unit** can be defined separately.

Mode **Length/Width**

In this mode, the line scan is displayed over the length and width of the object. This could be an oven, for example.

By specifying the **Width (Length of line)**, you determine how wide the scan line is.

With **Length (of scan)** the length of the object is mapped.

The **feed rate** is the speed with which the object is moved.

In the **Resulting linerate** field, the frequency of each line is automatically calculated. If a higher line frequency is defined than the camera and its scanning actually provide, a red exclamation mark is displayed (!).

Pre-carriage lines: For a better representation of the line scan, it makes sense in some cases to insert a certain number of dummy lines at the beginning.

The screenshot shows a configuration window titled "Presentation". It has two radio buttons for "Mode": "Length/Width" (which is selected) and "Linecount". To the right is a "Unit" field containing "m". Below these are several input fields with spinners and text boxes:

Parameter	Value	Unit
Width (Length of line):	3,00	[m]
Length (of scan):	5,00	[m]
Feed rate:	0,500	[m/sec]
Line count:	600	[lines]
Pre-carriage:	0,500	[m]
	0	[lines]
Resulting linerate:	50,0	[lines/sec]
Scan time:	10,0	[sec]
<input type="checkbox"/> User defined time:	60,0	[sec]

Mode **Linecount**

In this mode the display of the line scan is done by the scan time and the line count.

In the input field **Scan time** you define the time window in which the lines should be displayed. The basis for this can be the time of a process cycle.

By specifying the **line count** you can enter how many lines will be displayed in the Line scanner view. Number of lines will also define after how many lines the infrared image will be reloaded (Line scan)

Presentation

Mode: Length/Width Linecount Unit:

Scan time: [sec]

Width (Length of line): [m]

Line count: [lines]

Feed rate: [m/sec]

Pre-carriage: [lines] [m]

Auto sync.

Resulting linerate: [lines/sec]

Length (of scan): [m]

In the **Resulting linerate** field, the frequency of each line is automatically calculated. If a higher line frequency is defined than the camera and its scanning actually provide, a red exclamation mark (!) is displayed.

Pre-carriage lines: For a better representation of the line scan, it makes sense in some cases to insert a certain number of dummy lines at the beginning.

Keep aspect ratio option will adjust width of each line so that all lines will appear within the infrared image.

Keep aspect ratio

6.3.2. Triggered display of lines

Triggering signal can be used to control how the scanned lines will be arranged within the Line scanner view. In the **General** menu under **Line scanner configuration** (see 6.2.1) there are three modes provided.

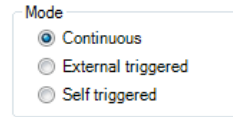

Continuous Line scan

Continuous mode will apply predefined values to display the scanned lines. No triggering signal will be used to control the line scanner presentation.

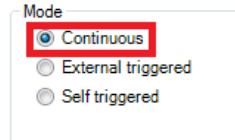

External triggered Line scan

External triggered option enables using an external triggering signal to control arranging of the scanned lines. Number of lines being reloaded after this signal is defined under **Lines** und **History [sec]** (see 6.3.1).

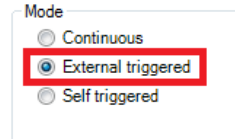

Further settings can be specified:

In **Flag operation** if you activate **Avoid during** refreshing of flag will not be executed during the line scan (see also 2.4.2).

Force after scan will execute the flag once given number of scanned lines is provided.

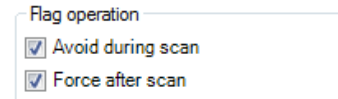

If activated **Avoid re-triggering during scan** will not allow to run a new line scan cycle while a previous cycle trigger by recent signal is not finished.

Trigger options

Avoid re-triggering during scan

Using **Avoid temperature analyzing, detecting alarm states and PIF operation during scan**, the three operations mentioned are performed only at the end of the scan. This is very helpful for performance reasons when a very high sampling rate (e.g. 1000 Hz, PI 1M/ 08M/ 05M) is set.

Analyzing operation

Avoid temperature analyzing, detecting alarm states and PIF operation during scan

Using **Correcting operation** and **Avoid all corrections based on internal temperature sensors during scan** can optionally prevent the recalculation of correction values in the triggered line scan.

Correcting operation

Avoid all corrections based on internal temperature sensors during scan



Note

For external triggering it is necessary to do modifications of the standard configuration on the Process Interface (PIF). You will find more details in the chapter **2.5**.

Self triggered Line scan

Using the **Self triggered** option it is possible to use a triggering signal provided by software to control arranging of the scanned lines. Number of lines being reloaded after this signal is defined under **Lines** und **History [sec]** (see **6.3.1**). Further modifications can be carried out:

Mode

Continuous

External triggered

Self triggered



How to setup line scan mode in PIX Connect
Software tutorial

<https://www.optris.global/how-to-setup-line-scan-mode-in-pix-connect>

First of all **Trigger area** within the infrared image needs to be specified. With the mouse you can make a graphic free positioning of the self trigger area in the sighting view. In the **Set Default** button you can choose between **Top**, **Bottom**, **Left**, **Right**, **Center** and **Full image**.

Trigger area

Left:	0	Right:	159
Top:	0	Bottom:	5

Set Default

Within the trigger area **Trigger thresholds** temperatures can be set to trigger the line scan cycle. **Holdoff time [s]** determines time frame within new signal should be neglected (e. g. if a signal from the heat source in the background is triggered). With **Trigger if below** count all temperatures below the entered limit, with **Trigger if above** all values above.

Trigger thresholds

<input type="checkbox"/> Trigger if below [°C]	0,0
<input checked="" type="checkbox"/> Trigger if above [°C]	100,0
Holdoff time [s]:	5,0



Under **Flag operation** and **Avoid during scan** can be set that refreshing of flag will not be executed during the line scan (see also 2.4.2). **Force after scan** will execute the flag once given number of scanned lines is provided.

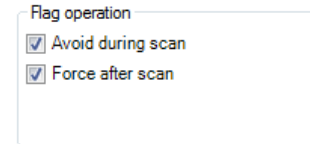

Flag operation

- Avoid during scan
- Force after scan

Using **Correcting operation** and **Avoid all corrections based on internal temperature sensors during scan** can optionally prevent the recalculation of correction values in the triggered line scan.

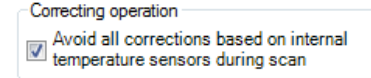

Correcting operation

- Avoid all corrections based on internal temperature sensors during scan

6.3.3. Snapshot configuration

To document the measurement results a complete line scan can be saved as snapshot. You will find the **Auto snapshots** settings options in the **Line scanner configuration** (see 6.2.1).

Using **Auto snapshots** and **Do snapshots any...** you can specify after how many line scans a snapshot should be captured and saved. If **Do snapshots with complete linescans only** is activated, the snapshot will be delayed with an externally triggered Line scan until the next scan starts. If the checkmark is not set (default), the snapshot will be taken directly at the end of the line scan.

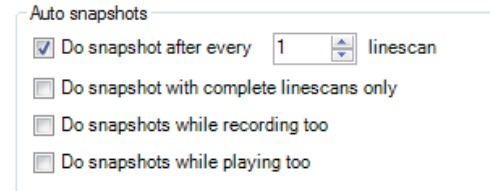

Auto snapshots

- Do snapshot after every linescan
- Do snapshot with complete linescans only
- Do snapshots while recording too
- Do snapshots while playing too

Do snapshots while recording too will also take snapshots during a simultaneous line scan recording. **Do snapshots while playing too** will take snapshots from a video recording during playback.

6.3.4. Zoom function of snapshots

Captured snapshots can be enlarged when viewed. To do this, open a saved snapshot (TIFF file), as described in chapter 3.1. Use **+** to zoom in and **-** to zoom out or use the bars on the side.

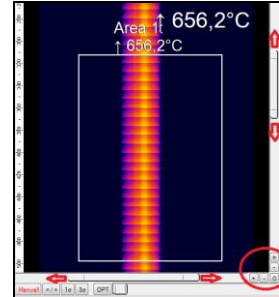

7. Merging

7.1. General Information

A further function in the PIX Connect software is the so-called merging. The merging allows the user to display several cameras in one software instance. This is very useful when whole processes, where several cameras are required, are to be displayed in a single screen.

Generally there are two ways to realize a merging. On the one hand you can connect the cameras directly to your computer via USB Port and on the other hand via the Ethernet network. Using the direct connection, it is really important to have several USB controllers at your PC. You find this information under the windows control panel, device manager and USB controller. One camera should be connected to one USB controller.

Advantages of camera merging

- If pixel size is getting too big, the use of multiple imagers is possible
- Simultaneous flag control and frame synchronization via PIF
- Measurement areas / hot-, coldspots works over whole area
- Different camera positions allow having various viewing angles for a complete view of a 3D object
- After the merging setup and the restart of the PIX Connect Software, the source instances will open automatically

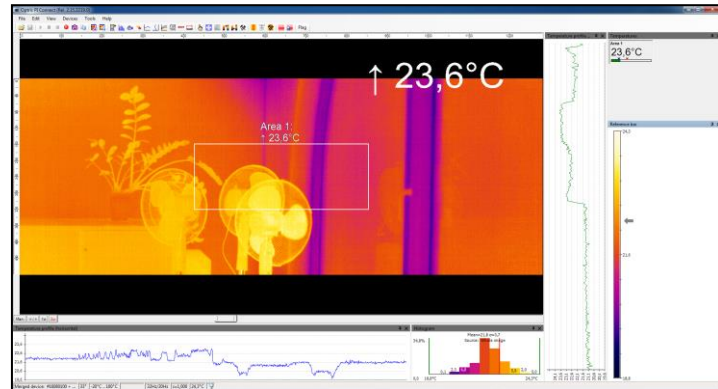

Note



- The Merging feature should only be used with cameras that use the same frame rate.
 - Depending on the number of cameras used, a powerful PC is necessary. Recommended is a PC with at least Intel Core i7, 16 GB RAM and 256 GB SSD.
 - Using a PIF: The PIF must be connected to the master camera. The configuration takes place in the merger instance.
 - PI 1M/08M/05M cameras are not supported.
-

Merging requires several instances. Each camera used gets its own instance. These are automatically generated during setup. The first created instance (Name: Instance 1) is the so-called **Master** instance. The other created instances (Name: Instance 2, Instance 3, etc.) are the so-called **Slave** instances. The final instance is the so-called **Merger** instance in which all cameras are displayed in one instance. The master and slave instances can/should be minimized after setup. Do not close the windows.



7.2. Direct Connection over USB Port

In this variant, the cameras are connected directly via USB to the PC. It is important to connect the individual cameras to different USB controllers because the maximum bandwidth of the USB interfaces is limited. We do not recommend using more than 3 cameras.

7.2.1. Configuration

At first connect all the cameras you want to use to your PC and open the PIX Connect software. Go to the menu **Tools** and **Merger settings**. Depending on how many cameras you want to use, click correspondently often the button **Add**. In this example, two cameras are used. Afterwards mark each instance one at another and press the **Start** button. The instances will open in a new window. The main window will contain the merging picture and the two other windows are the different instances of the individual cameras.

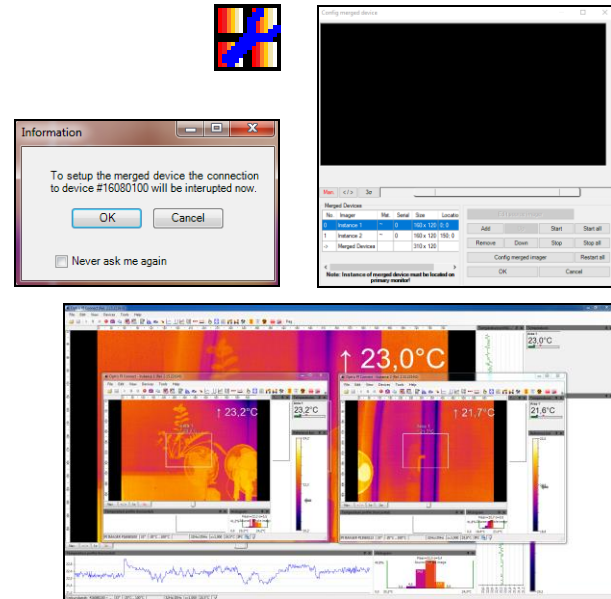

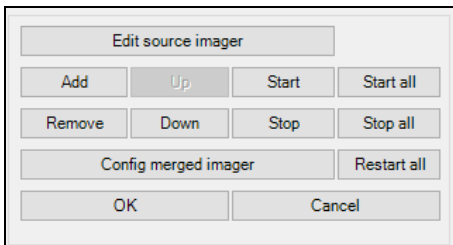

Now you have to assign this Instance to the first camera. To do that, go on the **Instance 1** window to **Tools**, **Configuration** and **Device**. Under **Application start** set a check on **Connect to device with SN** and press **pick current**. This instance is now assigned to this camera. Repeat the steps for all cameras.

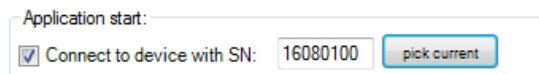

You can assign the different cameras to a specified instance by going to the instance window you want to assign and under menu **Devices**, select the camera you want to have.

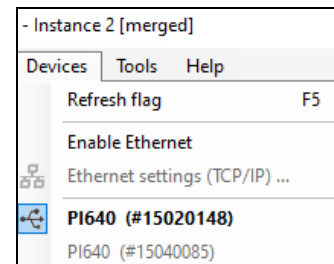

To adjust the pictures, go again over the main window to **Config merged device** like described before. Here you can directly select each instance and change the size, the position and the rotation of the imager (starting from software version 2.15.2222.0).

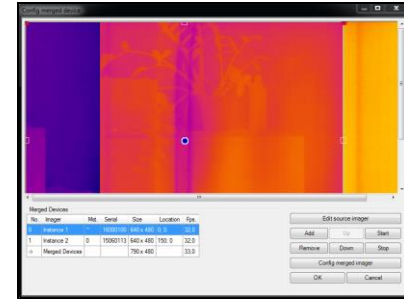

Another possibility to arrange the images of the different instances is also in the **Config merged device** window. Select the first instance (**Instance 1**) and click on **Edit source imager**. Here you make several modifications on your imager. You can change the name, the picture of the camera and the position of the picture. Under **Config target imager** you can define the exact position of the target. So here you define where the picture should start. Repeat the same with the second instance (**Instance 2**). You can arrange the picture side by side or on top of each other. The coordinates depends on the camera you're using. For example if you use two cameras with

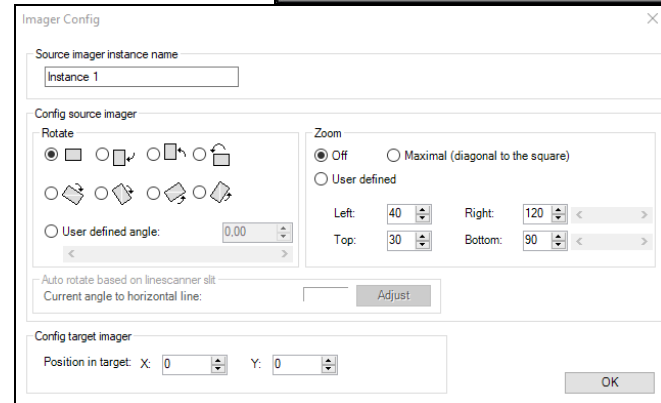

an optical resolution of 640 x 480 and the picture should be side by side you have to use following values for the whole picture:

e.g. PI 640	Position in target X	Position in target Y
Instance 1	0	0
Instance 2	639	0

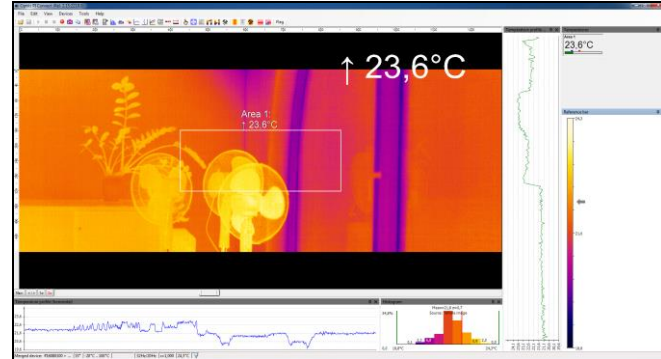

In this example the picture of the camera of Instance 1 is on the left side and the picture of the camera of Instance 2 begins lightly overlapping next to it. It is recommended a small overlapping of the pictures (up to 5 pixels) in order to have a smooth transition of the two pictures. The windows of the source instances can be minimized. Do not close the windows because than there will be no measuring in the main instance. They must run in the background or in the hidden mode.



Note

The instance of the merged device must be located on the primary monitor. If this is not the case, the note in the **Config merged device** Setup dialog box is highlighted in bold.

Merged Devices

No.	Imager	Mst.	Serial	Size	Location	Fps.
0	Instance 1	~	15040085	640 x 480	0; 0	30,1
1	Instance 2	0	15020148	640 x 480	150; 0	31,9
->	Merged Devices			790 x 480		19,1

Note: Instance of merged device must be located on primary monitor!

Under **Config merged imager**, further settings can be made for all instances.

With **Synchronize frames by digital input (DI) of PIF**, the frames of the connected cameras are simultaneous synchronized using the PIF. This can be done **on rising edge**, **on falling edge** or **on both edges**.

Mix overlapped edges makes a smooth transition between the singles images. It will be interpolated.

With **Adjust secondary imager(s) to master imager**, an adaptation of the pixels of the individual slave imagers to the master imager within the set temperature range is performed in the overlapping area.

The set temperature value at **maximum adjustment offset** indicates the maximum offset adjustment.

If the checkmark is set to **Ignore margin pixels**, the set margin pixel is not taken into account. A fixed number of margin pixels in the overlapping area does not work during line scanning when the gap is very narrow. Then no valid pixels are found.

Under **After flag operation only**, the pixels are adjusted only after a drawn flag and not continuously. Keep adjustment after restart ensures that the calculated offset of the secondary imager is preserved for the merging after program end.

Alarm if adjustment is overdue: Delay for 900 s, an alarm is output if the adjustment is exceeded after the set time.

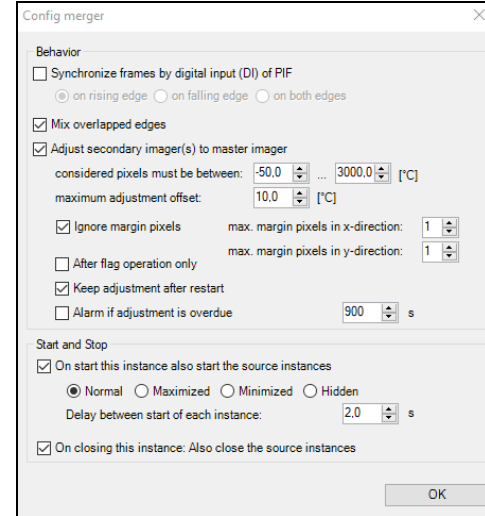

Further, you can make settings for the **Start and Stop** of the software. You can decide how the pictures of the source instances should be started. You can choose between **Normal**, **Maximized**, **Minimized** and **Hidden**. Also it is possible to close the source instances automatically when closing the Merger instance.

With **Delay between start of each instance** you can define the interval at which the individual instances are to be started one after the other. This is helpful when using the cameras via Ethernet to avoid possible communication problems.

Under menu **View**, **Windows** and **Merger** a tool window opens with a view of the available instances of the merged device.



7.3. Connection via the Ethernet network

The second possibility is a connection via the Ethernet network. Each camera is connected to one individual USB Server Gigabit and those in turn are connected to the Ethernet switch. The switch than is attached to the PC. For the connection via network you can use more than 3 cameras for the merging.

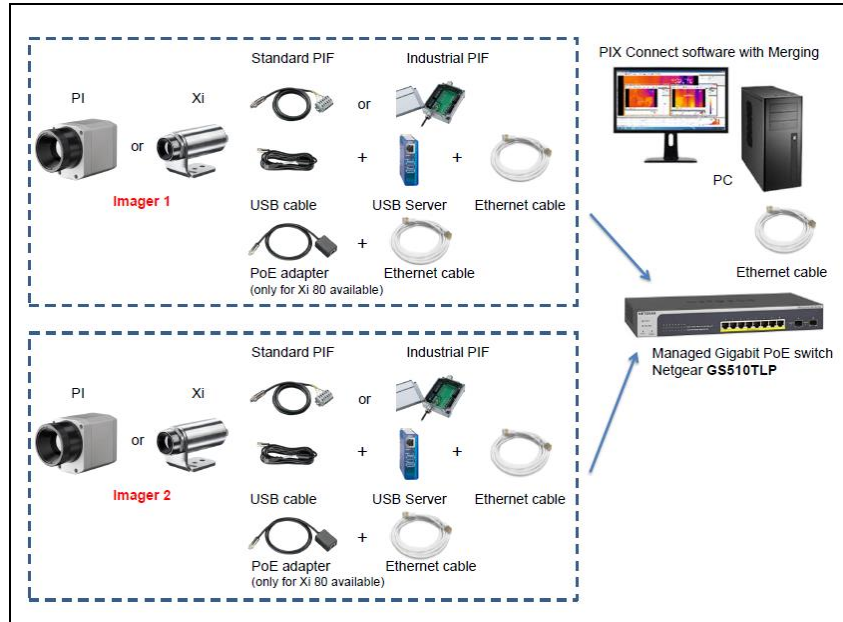

The configuration of the merging is the same as described in chapter 7.2.1.

You find a detailed description and procedure for the installation of USB Server Gigabit on the USB stick in the folder Documentation and Manuals.

7.4. Merging with the use of the PIF

In Merging mode, inputs and outputs can be used as usual via the PIF. It must be ensured that the PIF must be connected to the master camera (Instance 1). The settings in the software are made via the merger instance.

The note on PIF at instance "Instance 1" shows that the PIF is being used by the master camera.

If analog outputs are used in the merger instance, they must be activated in the master instance. For this purpose, the used outputs must be set to **External Communication**:

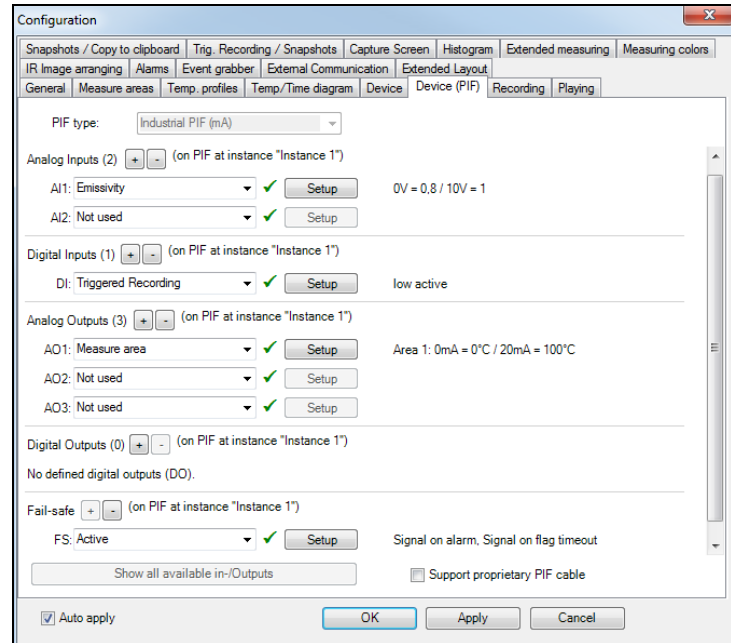
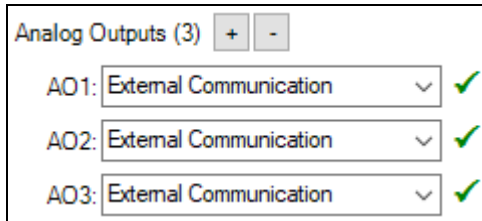

Configuration dialog of Merger Instance

7.5. Simultaneous flag control

In Merging mode, it is important for the synchronization of the image that the flag of the cameras used is drawn at the same time. This function is already set automatically. For older software versions, you still need to configure these settings. No additional hardware, such as the Process Interface (PIF), is required.

For the merger instance, the flag automation must be activated and deactivated for the master and slave instances.

In the configuration dialog under **Device** the flag automatic can be activated or deactivated.



Flag automatic	
Merger Instance	On
Master Instance	Off
Slave Instance(s)	Off

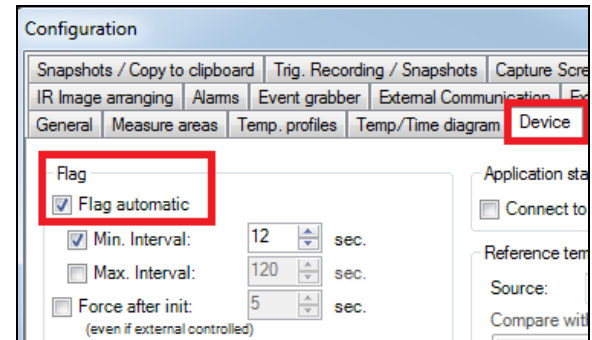

7.6. Simultaneous frame synchronization via PIF

For simultaneous frame synchronization, use the PIF connection from the PI camera. You can choose between the standard PIF and the industrial PIF depending on how many in- and outputs you want to use.

In this example, the standard PIF is used. One camera will be chosen as the master and the others are the slaves. Please connect the digital input with the analog output of the master PIF and from the analog output you connect all digital inputs of the slaves together.

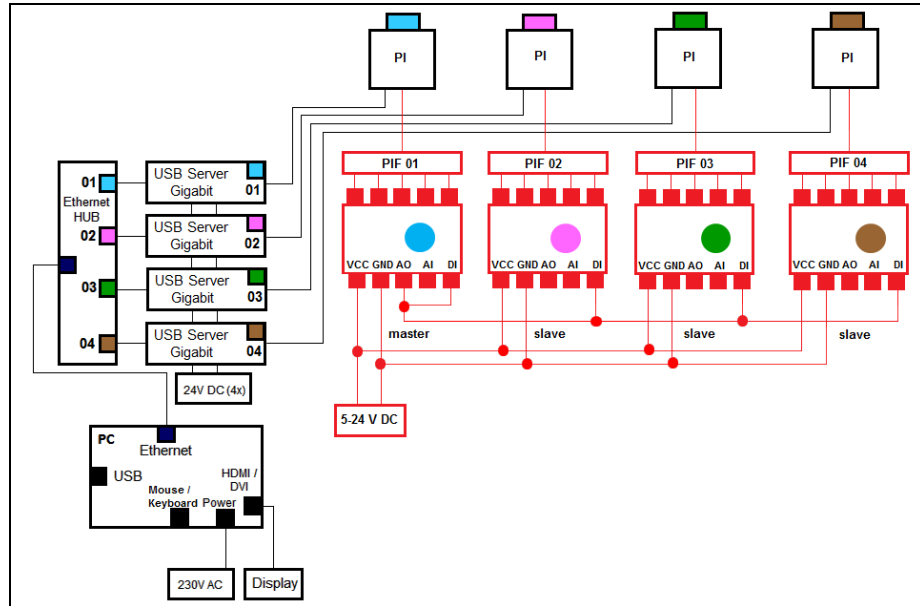

After you connected all your PIFs together, you need to set up the settings in the PIX Connect software. Therefore go to menu **Tools** and **Merger settings**.

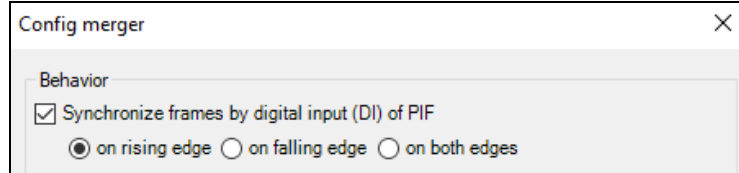

Then click on **Config merged imager** and enable **Synchronize frames by digital input (DI) of PIF**.

The flag automatic must be activated for the Merger instance and deactivated for the master and slave instances (see section 7.5)

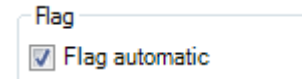

Flag automatic	
Merger Instance	On
Master Instance	Off
Slave Instance(s)	Off

8. Further information

8.1. Options

Under **Tools**, **Extended** and **Options**, you can make further settings, which are explained in the following.

8.1.1. Activating software messages

At some point a warning message will appear when performing an action that would cause changes to software settings.

To prevent unintended changes you can activate or deactivate these messages.

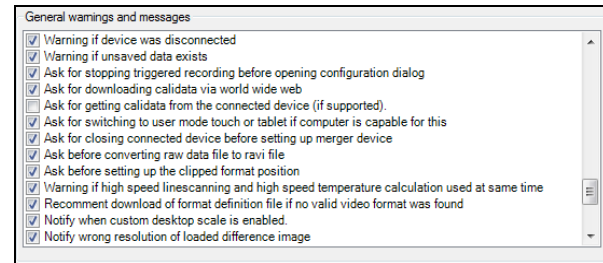

Note

If a message appears you can disable the window by choosing „Never ask me again“. Using the menu **Options** you can activate the appearance of the window again.

Important options are:

Warning if device was disconnected	A window tells the user that a device was disconnected.
Warning if unsaved data exists	If activated a reminder will appear to warn you on unsaved data or setups before shutting down the software.

Ask for stopping triggered recordings...

Opening the configuration dialog you will be asked whether to close a triggered data capturing or not. The message intends to prevent changing trigger settings by accident.

8.1.2. Layouts

Under **Layouts** you can choose how a layout should be saved or loaded together. The layouts are independent of the connected device.

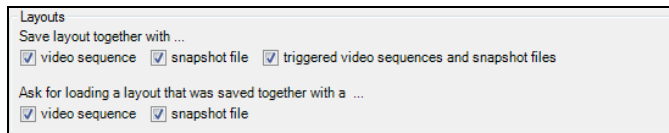

8.1.3. Temperature unit

When setting the **Temperature unit** you can choose between **Celsius (°C)** and **Fahrenheit (°F)**. Alternatively, the temperature unit can also be changed by pressing the right mouse button in the live IR image.

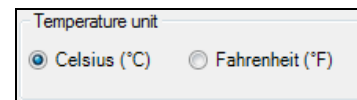

8.1.4. Log events

Also you can activate **Log events**. If it's selected, messages (for example fail-safe events) will be logged. These can be found under menu **View**, **Windows** and **Event protocol** or at: (C:\Users\AppData\Roaming\Imager\Event)

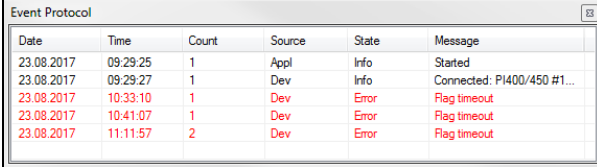

Date	Time	Count	Source	State	Message
23.08.2017	09:29:25	1	Appl	Info	Started
23.08.2017	09:29:27	1	Dev	Info	Connected: PI400/450 #1...
23.08.2017	10:33:10	1	Dev	Error	Flag timeout
23.08.2017	10:41:07	1	Dev	Error	Flag timeout
23.08.2017	11:11:57	2	Dev	Error	Flag timeout

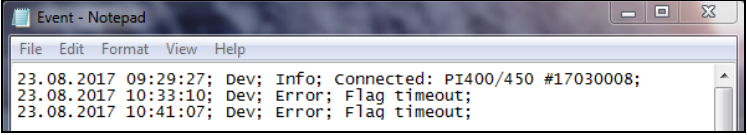

```
Event - Notepad
File Edit Format View Help
23.08.2017 09:29:27; Dev; Info; Connected: PI400/450 #17030008;
23.08.2017 10:33:10; Dev; Error; Flag timeout;
23.08.2017 10:41:07; Dev; Error; Flag timeout;
```

8.2. System requirements

Minimum system requirements:

- Windows 7
- USB 2.0-interface
- At least 2 GB RAM
- 2,0 GHz processor power

Recommended system requirements:

- Windows 10
- At least 2 GB hard disk storage for IR videos
- At least 4 GB RAM

Note: Running the software under embedded systems and server operating systems cannot be guaranteed.

8.3.

8.4. About software

In the **Help** and **About** submenu you will find the version of PIX Connect software you are currently running, the imager hardware and the imager firmware.



8.5. Extended Configuration

Under **Tools** and **Extended** you can configure different adjustments.

Under **Options** you can choose general warnings and messages (see 8.1.1).

Load calibration data:

- **From Internet:** Will re-download the files via an existing Internet connection.
- **From device:** The calibration files are reloaded from the device (appears only for Xi 80/410).
- **From directory:** If there is no Internet connection, the files can also be imported via the supplied data medium (via the directory Califiles SNxxxxxxx).

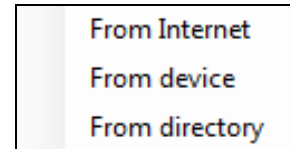
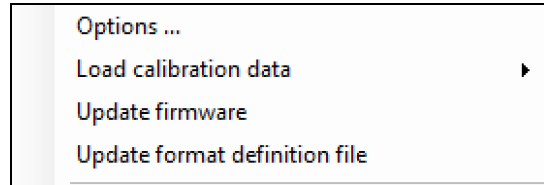

The **firmware update** should be checked at regular intervals so that you always have the latest version on your device. The **format definition file update** ensures that the current video formats are supported.

8.6. Overview shortcuts

Shortcut	Description
F1	Snapshot
Alt+F1	Copy snapshot to clipboard
F2	Record
F3	Stop
Alt+F4	Exit
F5	Refresh flag
F6	Save screenshot
Alt+F6	Copy screenshot to clipboard
F7	Capture screen
Alt+F7	Replay captured screen
F10	Acknowledge alarm

Alt+Enter	Full screen
Alt+C	Configuration
Alt+H	Horizontal mirror
Alt+P	Next palette
Ctrl+Alt+P	Previous palette
Alt+S	Image subtraction
Ctrl+Alt+S	Image subtraction from file
Alt+V	Vertical mirror
Ctrl+L	Line scanner sighting view
Ctrl+Alt+C	Line scanner settings
Ctrl+Alt+L	Enable line scanner