



INFRARED CAMERAS

The most versatile infrared cameras in the world

when temperature matters

Advanced thermal measurement systems

Optris' infrared cameras are fully radiometric stationary thermographic systems with an excellent price-performance ratio. The thermal imaging cameras are connected to a PC via USB and Ethernet and they are immediately ready to be used. Temperature data is displayed through optris PIX Connect – the license-free analysis software.

Non-contact temperature measurement made in Germany

Optris IR measurement devices enable constant monitoring and control of virtually every manufacturing process, and reductions in production costs through specific process optimization.

Once purchased, thermal imager are essential pieces of equipment used in a numerous industrial applications, e.g.

- Glass
- Plastics
- Metal
- Automotive
- Electric utility sector
- Fire prevention / Safety
- Maintenance
- Life Science / Medical
- 3D printing & Additive manufacturing

For more infos on application examples see page 19.

Applications Support

Optris application engineers and distribution partners have the experience and technical background necessary to apply its extensive portfolio of IR cameras and accessories to your temperature measurement challenge. Contact us directly or attend our numerous technical training events and YouTube presentations.



Further information on non-contact temperature measurement see our brochure:

IR Basic Principles

www.optris.com/en/download/infrared-basics



Learn more about infrared technology and check out our website:

IR Lexicon

www.optris.com/en/support/lexicon

Have you seen our YouTube – Channel?

Learn more about Optris' infrared temperature measurement devices and their setup, properties and special features.

The Optris YouTube channel will give you an overview of our company and the world of infrared measurement technology.

Our videos will help you discover the functionality of our products and learn how to use them for your business:



- New products,
- How to's,
- Software tutorials
- Hands-on-trainings

optris

optris® Xi series Spot finder IR camera

Safety Applications: 144.4°C

Condition Monitoring

Substation Monitoring

Injection molding

Automotive

Plastics: Ø 104

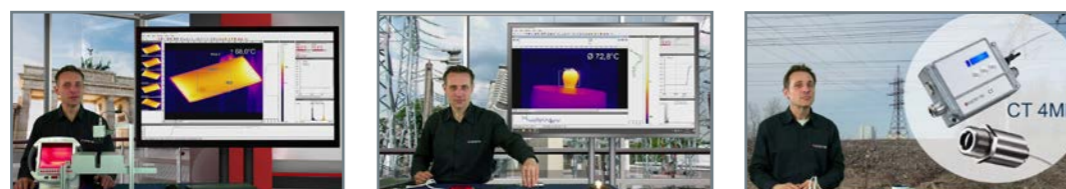

Advantages Xi Compact Line

- Compact affordable industrial imager for temperature measurements from -20 to 900 °C
- Motorized focus
- Autonomous operation (without PC) with automatic spot finder and direct analog output – ideal for OEM use (Xi 80 / 410)
- Direct Ethernet interface (Xi 80 / 410)



Automatic hot spot search

Objects can be thermally analyzed and hot or cold spots can be found automatically.

Advantages PI Precision Line

- Interchangeable lenses
- Suited for fast processes (up to 1 kHz)
- High thermal sensitivity (up to 40 mK NETD)
- High optical resolution (up to 764 x 480 Pixel)
- Laser blocking filters
- Temperature measuring ranges from -20 to 2450 °C
- Different spectral ranges (500 nm 800 nm / 1 µm / 7.9 µm / 8 – 14 µm)
- Delivered with test certificate

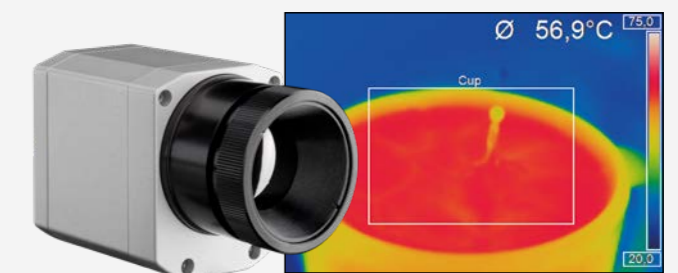

Fast measurements

Temperature distributions on a surface can be precisely recorded at millisecond intervals.

Autonomous operation with direct analog output

Up to 9 freely definable measuring areas may be used as analog outputs when using an external process interface.



Simple process integration

Software Development Kit (SDK) for integration of the camera into customer-specific software via Dynamic Link Library (DLL) or COM-Port.

Interfaces to LabView and MATLAB are included as well.

optris Microscope optics

The interchangeable and focusable microscope optics enable electrical testing and thermal analysis of smallest components at the same time - with an optical resolution of up to 28 µm. Fast processes can easily be monitored with a frame rate of up to 125 Hz and, with the recording of radiometric video sequences and images, be saved for later analysis.



**Compact spot finder
IR camera**



- Industrial imager for precise temperature measurements from -20 to 900 °C
- Rugged, compact imager with motorized focus
- Autonomous operation with automatic spot search and direct analog output
- Up to 80 Hz frame rate for the monitoring of fast thermal processes
- Extensive ready-to-use package for an attractive price – incl. versatile image processing software with line scan mode and connection cables

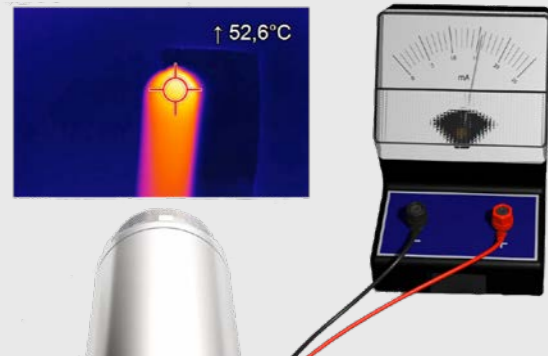

Pyrometer or camera?

The Xi series is a fusion of a rugged, compact pyrometer and a modern IR camera.

Thanks to analog and digital outputs as well as the option to process up to nine freely definable measuring areas using an external process interface, the Xi camera is perfectly suited for OEM applications.

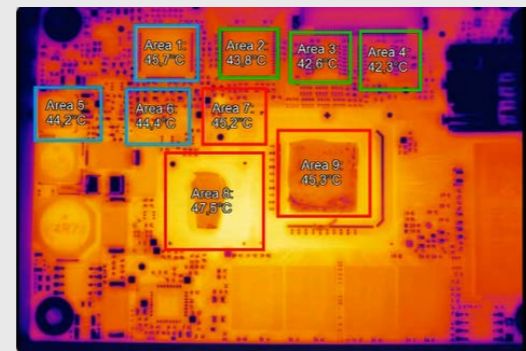

Integrated spot finder function

The integrated spot finder function allows for precise temperature measurements of moving objects - without having to readjust the sensor.

The camera figures it out on its own, without being connected to a PC.

**Easy integration into PLCs via
RS485 interface**



Motor focus simplifies handling

The Xi models are equipped with a motorized focus.

The free PIX Connect software enables a remote focusing from the distance.

**Microscope optics
for the inspection of
assembled circuit boards**

- Optical resolution of 382 x 288 pixels for exact temperature measurement of -20 °C to 900 °C
- Small sized rugged camera with motorized focus
- 80 Hz frame rate for monitoring of fast thermal processes - Real-time thermographic images in high speed
- Recording of radiometric videos
- Extensive ready-to-use package for an attractive price – including versatile image processing software and connection cables



The microscope optics for the Xi 400 allows reliable temperature measurement on tiny objects from 240 µm.

In combination with a suitable stand, this enables professional measurement of printed circuit boards and components in the electronics industry. The measuring distance between camera and object is variable between 90 and 110 mm. The built-in motor focus allows for an easy focussing of the camera with the included software PIX Connect.

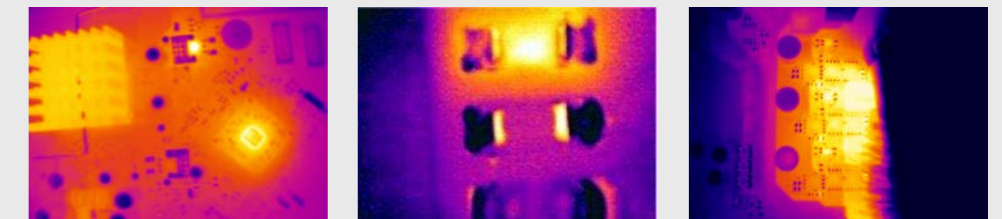

Areas of application

Circuit boards are a core part of electronic devices. They keep getting smaller while having to be more powerful at the same time.

Temperatures of assembled circuit boards can easily be measured with the microscope optics of the optris Xi 400 thermal imager, thus identifying overheated areas quickly and preventing possible defects.

The causes for excessive temperatures can be manifold: defective components, incorrectly dimensioned circuit paths or poorly soldered joints.



Basic model	Xi 80	Xi 400	Xi 410
Compact spot finder IR camera for use in harsh industrial environments, autonomous operation possible.			
Detector	FPA, uncooled (34 µm pitch)	FPA, uncooled (17 µm pitch)	FPA, uncooled (17 µm pitch)
Optical resolution	80 x 80 pixels	382 x 288 pixels	384 x 240 pixels
Spectral range	8 – 14 µm	8 – 14 µm	8 – 14 µm
Temperature ranges	-20 ... 100 °C; 0 ... 250 °C; (20) 150 ... 900 °C ¹⁾	-20 ... 100 °C; 0 ... 250 °C; (20) 150 ... 900 °C; 200...1500 °C (option) ²⁾	-20 ... 100 °C; 0 ... 250 °C; (20) 150 ... 900 °C ¹⁾ ; 200 ... 1500 °C (option) ²⁾
Frame rate	50 Hz	80 Hz / 27 Hz	Ethernet: 25 Hz / USB: 4 Hz autonomous operation: (without PC) 1.5 Hz
Optics (FOV)	30° (f = 5.1 mm / F = 0.9) 12° (f = 12.7 mm / F = 1.0) 55° (f = 3.1 mm / F = 0.9) 80° (f = 2.3 mm / F = 0.9)	29° x 22° (f = 12.7 mm / F = 0.9) 18° x 14° (f = 20 mm / F = 1.1) 53° x 38° (f = 7.7 mm / F = 0.9) 80° x 54° (f = 5.7 mm / F = 0.9)	29° x 18° (f = 12.7 mm / F = 0.9) 18° x 12° (f = 20 mm / F = 1.1) 53° x 31° (f = 7.7 mm / F = 0.9) 80° x 44° (f = 5.7 mm / F = 0.9)
Microscope optics	–	18° x 14° (f = 20 mm / F=1.1), Smallest measuring spot (IFOV): 80 µm	–
Focus	Motorized focus	Motorized focus	Motorized focus
Optical resolution (D:S)	190:1 (12° optics)	390:1 (18° optics)	390:1 (18° optics)
Thermal sensitivity (NETD)³⁾	100 mK	80 mK	80 mK
System accuracy (at T_{Amb} = 23 ±5 °C)	±2 °C or ±2 %, whichever is greater	±2 °C or ±2 %, whichever is greater	±2 °C or ±2 %, whichever is greater
PC interfaces	USB 2.0 / Ethernet (100 Mbit/s) / PoE	USB 2.0 / optional USB to GigE (PoE) interface	USB 2.0 / Ethernet (100 Mbit/s) / PoE
Direct in-/outputs / Standard process interface (PIF)	1x 0/4–20 mA output 1x input (analog or digital) electrically isolated	1x 0–10 V input 1x digital input (max. 24 V) 1x 0–10 V output	1x 0/4–20 mA output 1x input (analog or digital) electrically isolated
Industrial process interface (PIF)	3x analog outputs (0/4–20 mA or 0–10 V) or alarm OUT (relais), 3x inputs (analog or digital), fail-safe (LED and relay), stackable up to 3 PIFs; electrically isolated	2 x 0–10 V inputs, 1 x digital input (max. 24 V), 3x 0/4-20 mA outputs, 3 x relais (0–30 V / 400 mA), fail-safe relay	3x analog outputs (0/4–20 mA or 0–10 V) and 3x alarm outputs (relais) / 3x inputs (analog or digital) / fail-safe (LED and relay) stackable up to 3 PIFs; electrically isolated
Cable length	USB: 1 m, 3 m, 5 m Ethernet: 100 m, RS485: 500 m	USB: 1 m, 3 m, 5 m, 10 m, 20 m	USB: 1 m, 3 m, 5 m Ethernet: 100 m, RS485: 500 m
Ambient temperature (T_{Amb})	0 °C ... 50 °C	0 °C ... 50 °C	0 °C ... 50 °C
Size	Ø 36 x 90 mm (M30x1 thread)	Ø 36 x 100 mm (M30x1 thread)	Ø 36 mm x 100 mm (M30x1 thread)
Environmental rating	IP 67 (NEMA 4)	IP 67 (NEMA 4)	IP 67 (NEMA 4)
Weight (without mounting bracket)	201 - 210 g (depending on lens)	216 - 220 g (depending on lens)	216 - 220 g (depending on lens)
Power supply	USB / PoE / 5-30 VDC	via USB	USB / PoE / 5-30 VDC
Power consumption (typical values)	1.5 W	1.5 W	1.5 W
Scope of supply (standard)	<ul style="list-style-type: none"> Xi camera USB cable (1 m) Cable for in-/outputs (1 m) with terminal block Mounting bracket with tripod thread, mounting nut Software package optris PIX Connect Quick start guide 	<ul style="list-style-type: none"> Xi camera USB cable (1 m) Cable for in-/outputs (1 m) with terminal block Mounting bracket with tripod thread, mounting nut Software package optris PIX Connect Quick start guide 	<ul style="list-style-type: none"> Xi camera Ethernet / PoE cable (1 m) / USB cable (1 m) Cable for in-/outputs (1 m) with terminal block Mounting bracket with tripod thread, mounting nut Software package optris PIX Connect Quick start guide

1) Accuracy effective starting at 150 °C

2) If this option is ordered the (20)150 ... 900 °C range is not available

3) LT: Measurement of the noise equivalent temperature difference (NETD) according to VDI 5585 standard, method B; 25 °C black body temperature (-20 - 100 °C range), frame rate 20 Hz averaged

Air purge unit	Water cooled housing	Shutter
ACXIAPL + ACXIAPLAB (Mounting bracket)	ACXIW	ACXISCBxx* + ACXIAPLAB (Mounting bracket)
Features <ul style="list-style-type: none"> The air purge attachment can be used in combination with the water cooled housing and protects the optics from contamination Used in rough and dusty areas to guarantee a reliable temperature measurement 	Features <ul style="list-style-type: none"> The rugged water cooled housing allows the Xi infrared cameras to be employed in hot environments up to 250°C Respective heat-resistant cables are also available 	Features <ul style="list-style-type: none"> In addition Xi cameras can be equipped with a shutter The shutter protects the optics from falling parts within a response time of 100 ms

*) xx = for different cable lengths

Outdoor protective housing for Xi series	USB server Gigabit 2.0 for Xi 400	Industrial process interface (PIF) for Xi series
ACXIOPH24	ACPIUSBSGB	Xi 80 / Xi 410: ACXIPIFCBx* Xi 400: ACXIPIFACBx*
Features <ul style="list-style-type: none"> Environmental rating IP 66 Additional air purge collar allows continuous operation in dusty and humid environments Heating element and built-in fan enable for a 24/7 operation from -40 °C to 50 °C Installation of USB Server Gigabit 2.0 and industrial process interface possible for integration into control systems over large outdoor distances 	Features <ul style="list-style-type: none"> Fully USB 2.0 compatible, Data rates: 1.5 / 12 / 480 mbps, USB transfer mode: Isochronous Network connection via Gigabit Ethernet Full TCP/IP support incl. routing and DNS Two independent USB ports Supply from PoE or external power supply with 24 – 48 V DC Galvanic isolation 500 V_{RMS} (network connection) Remotely configurable via Web Based Management 	Features <ul style="list-style-type: none"> Industrial process interface for Xi 400 with 3 analog / alarm outputs, 2 analog inputs, 1 digital input, 3 alarm relais Industrial process interface for Xi 80 and Xi 410 with 3 analog- / alarm outputs, 3 inputs (analog or digital), 3 alarm relais 500 V AC_{RMS} isolation voltage between camera and process Separate fail-safe relay output Xi hardware including all cable connections and PIX Connect software are permanently observed during operation Option Xi 80: stackable up to 3 PIFs

*) x = for different cable lengths

Infrared cameras

with high resolution for fast online applications and exchangeable lenses, including line scan function

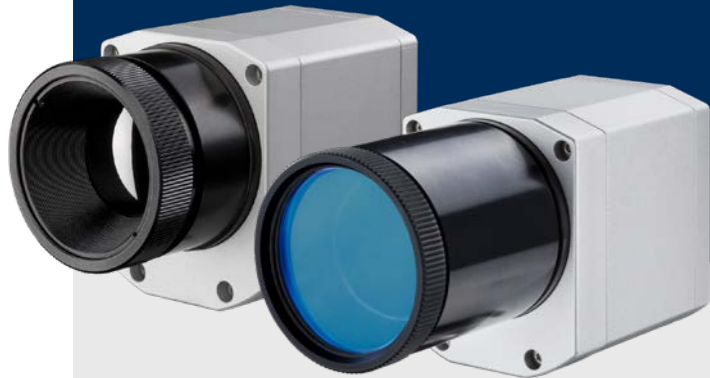

PI series Precision Line

The PI Precision Line includes numerous IR cameras for temperature measurement in industrial process control and research applications. From the mid-range resolution of the PI 400i / 450i to the high resolution PI 640i and special thermal imagers for metal, glass and microscopic targets, Optris Precision IR cameras meet every customer requirement.



IR camera configurator:



www.optris.com/en/ir-camera-configurator

For further information on our infrared cameras visit our website

PI series - the Precision Line

www.optris.com/en/products/infrared-cameras/pi-series



Infrared cameras PI series						
Basic model		PI 400i / PI 450i	PI 640i	PI 640i Microscope optics	PI 450i G7	PI 640i G7
Detector		FPA, uncooled (17 µm pitch)	FPA, uncooled (17 µm pitch)	FPA, uncooled (17 µm pitch)	FPA, uncooled (17 µm pitch)	FPA, uncooled (17 µm pitch)
Optical resolution		382 x 288 pixels	640 x 480 pixels VGA	640 x 480 pixels @ 32 Hz 640 x 120 pixels @ 125 Hz	382 x 288 pixels	640 x 480 pixels
Spectral range		8–14 µm	8–14 µm	8–14 µm	7.9 µm	7.9 µm
Temperature ranges		-20 ... 100 °C 0 ... 250 °C (20) 150 ... 900 °C ¹⁾ 200 ... 1500 °C (optional)	-20 ... 100 °C 0 ... 250 °C (20) 150 ... 900 °C ¹⁾ 200 ... 1500 °C (optional)	-20 ... 100 °C 0 ... 250 °C (20) 150 ... 900 °C ¹⁾ 200 ... 1500 °C (optional)	150 ... 900 °C 200 ... 1500 °C	150 ... 900 °C 200 ... 1500 °C
Frame rate		80 Hz / switchable to 27 Hz	32 Hz / 125 Hz in subframe mode (640 x 120 pixels)	32 Hz / 125 Hz in subframe mode (640 x 120 pixels)	80 Hz / switchable to 27 Hz	32 Hz / 125 Hz in subframe mode (640 x 120 pixels)
Optics (FOV) exchangeable		29° x 22° (f = 12.7 mm / F = 0.9) 18° x 14° (f = 20 mm / F = 1.1) 53° x 38° (f = 7.7 mm / F = 0.9) 80° x 54° (f = 5.7 mm / F = 0.9)	33° x 25° (f = 18.7 mm / F = 0.8) 15° x 11° (f = 41.5 mm / F = 1.0) 60° x 45° (f = 10.5 mm / F = 0.8) 90° x 64° (f = 7.7 mm / F = 0.8)	12° x 9° (f = 44 mm / F = 1.1) Smallest measuring spot (IFOV): 28 µm	29° x 22° (f = 12.7 mm / F = 0.9) 18° x 14° (f = 20 mm / F = 1.1) 53° x 38° (f = 7.7 mm / F = 0.9) 80° x 54° (f = 5.7 mm / F = 0.9)	33° x 25° (f = 18.7 mm / F = 0.8) 15° x 11° (f = 41.5 mm / F = 1.0) 60° x 45° (f = 10.5 mm / F = 0.8) 90° x 64° (f = 7.7 mm / F = 0.8)
Thermal sensitivity (NETD) ²⁾		PI 400i: 75 mK with 29°, 53°, 80° FOV PI 400i: 100 mK with 18° FOV / F = 1.1 PI 450i: 40 mK with 29°, 53°, 80° FOV PI 450i: 60 mK with 18° FOV / F = 1.1	40 mK with 33°, 60° and 90° FOV 60 mK with 15° FOV	80 mK	150 mK 175 mK with 18° FOV	80 mK with 33°, 60°, 90° FOV 120 mK with 15° FOV
System accuracy (at T _{Amb} = 23 ± 5 °C)		±2 °C or ±2 %, whichever is greater	±2 °C or ±2 %, whichever is greater	±2 °C or ±2 %, whichever is greater	±2 °C or ±2 %, whichever is greater	±2 °C or ±2 %, whichever is greater
Temperature coefficient		±0.05 % / K ³⁾	±0.05 % / K ³⁾	±0.05 % / K ³⁾	-	-
PC interfaces		USB 2.0 / optional USB to GigE (PoE) Interface	USB 2.0 / optional USB to GigE (PoE) Interface	USB 2.0 / optional USB to GigE (PoE) Interface	USB 2.0 / optional USB to GigE (PoE) Interface	USB 2.0 / optional USB to GigE (PoE) Interface
Process interface (PIF)	Standard PIF	1x 0 – 10 V input, 1x digital input (max. 24 V), 1x 0 – 10 V output	1x 0 – 10 V input, 1x digital input (max. 24 V), 1x 0 – 10 V output	1x 0 – 10 V input, 1x digital input (max. 24 V), 1x 0 – 10 V output	1x 0 – 10 V input, 1x digital input (max. 24 V), 1x 0 – 10 V output	1x 0 – 10 V input, 1x digital input (max. 24 V), 1x 0 – 10 V output
	Industrial PIF (optional)	2x 0 – 10 V input, 1x digital input (max. 24 V), 3x 0 / 4–20 mA output, 3x relais (0 – 30 V / 400 mA), 1x fail-safe-relay	2x 0 – 10 V input, 1x digital input (max. 24 V), 3x 0 / 4–20 mA output, 3x relais (0 – 30 V / 400 mA), 1x fail-safe-relay	2x 0 – 10 V input, 1x digital input (max. 24 V), 3x 0 / 4–20 mA output, 3x relais (0 – 30 V / 400 mA), 1x fail-safe-relay	2x 0 – 10 V input, 1x digital input (max. 24 V), 3x 0 / 4–20 mA output, 3x relais (0 – 30 V / 400 mA), 1x fail-safe-relay	2x 0 – 10 V input, 1x digital input (max. 24 V), 3x 0 / 4–20 mA output, 3x relais (0 – 30 V / 400 mA), 1x fail-safe-relay
Ambient temperature (T _{Amb})		PI 400i: 0 ... 50 °C / PI 450i: 0 ... 70 °C	0 ... 50 °C	0 ... 50 °C	0 ... 70 °C	0 ... 50 °C
Size		46 x 56 x 68 – 77 mm (depending on lens and focus position)	46 x 56 x 76 - 100 mm (depending on lens and focus position)	46 x 56 x 119 - 126 mm (depending on lens and focus position)	46 x 56 x 68 – 77 mm (depending on lens and focus position)	46 x 56 x 76 – 100 mm (depending on lens and focus position)
Environmental rating		IP 67 (NEMA 4)	IP 67 (NEMA 4)	IP 67 (NEMA 4)	IP 67 (NEMA 4)	IP 67 (NEMA 4)
Weight		237 - 251 g, depending on lens	269 - 340 g, depending on lens	370 g, depending on lens	237 - 251 g, depending on lens	269 - 340 g, depending on lens
Power supply		via USB	via USB	via USB	via USB	via USB
Power consumption (typical values)		1.5 W	1.5 W	1.5 W	2.5 W	2.5 W
Scope of supply (standard)		<ul style="list-style-type: none"> USB camera with 1 lens USB cable (1 m) Table tripod PIF cable with terminal block (1 m) Manual Aluminum case (PI 400i) Rugged outdoor case (PI 450i) Software package optris PIX Connect 	<ul style="list-style-type: none"> USB camera with 1 lens USB cable (1 m) Table tripod PIF cable with terminal block (1 m) Manual Rugged outdoor case Software package optris PIX Connect 	<ul style="list-style-type: none"> USB camera with lens kit (standard lens [PI 640i: O33], microscope lens [MO44]) Microscope stand Standard USB cable (1 m) Standard-PIF Manual Rugged outdoor case Software package optris PIX Connect 	<ul style="list-style-type: none"> USB camera with 1 lens USB cable (1 m) Table tripod PIF cable with terminal block (1 m) Manual Rugged outdoor case Software package optris PIX Connect 	<ul style="list-style-type: none"> USB camera with 1 lens USB cable (1 m) Table tripod PIF cable with terminal block (1 m) Manual Rugged outdoor case Software package optris PIX Connect

1) Accuracy effective starting at 150 °C

2) LT: Measurement of the noise equivalent temperature difference (NETD) according to VDI 5585 standard, method B; 25 °C black body temperature (-20-100 °C range), frame rate 20 Hz averaged

G7: Measurement of the noise equivalent temperature difference (NETD) according to VDI 5585 standard, method B; 650 °C black body temperature, frame rate 20 Hz averaged

3) For T_{Amb} 10...50 °C and T_{obj} ≤ 500 °C; otherwise: ± 0.1 K/K or 0.1%/K (whichever is greater)

One of the smallest cameras in its class

- One of the smallest cameras in its class (46 x 56 x 68 – 77 mm)
- Very good thermal sensitivity at 75 mK
- Thermal image recording up to 80 Hz
- Interchangeable lenses & industrial accessories
- Detector with 382 x 288 pixels
- Lightweight (237 – 251 g, depending on lens)
- Includes license-free analysis software and full SDK



High performance for a wide range of applications

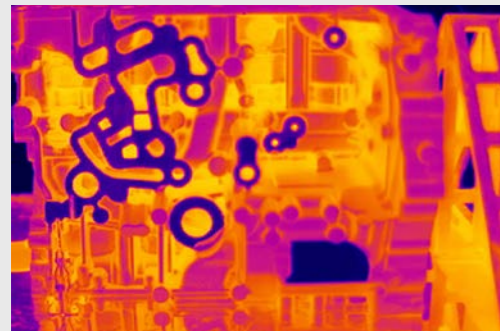

The high-performance optris PI 400i infrared camera has a wide range of uses in industry.

For example, thermal image shots help to monitor processes and ensure the quality of manufactured products in the automotive field, in particular in the manufacturing of plastics as well as in the semiconductor and photovoltaic industry.

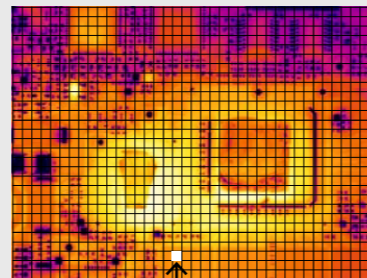

382 x 288 Pixel 10 x 10 Pixel = 40 mm²

SMD chip as measurement object:
measurement field size: 240 mm x 180 mm,
pixel size: 0.63 mm

80 Hz recordings with full pixel resolution

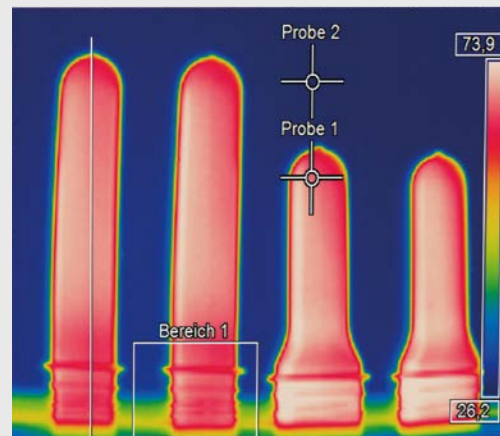

Thermal image shots of preforms in PET bottle production

The display and recording of thermal images at full optical resolution can be done at high measurement speeds of 80 frames per second.



Application examples, e.g. in the plastics industry:

www.optris.com/en/industries/plastics

Detection of minimal temperature differences

- One of the smallest cameras in its class (46 x 56 x 68 – 77 mm)
- Exceptional thermal sensitivity at 40 mK
- Thermal image recording up to 80 Hz
- Interchangeable lenses & industrial accessories
- Detector with 382 x 288 pixels
- Lightweight (237 – 251 g, depending on lens)
- Usable at ambient temperatures of up to 70 °C without the need for additional cooling
- Includes license-free analysis software and full SDK



Highest temperature resolution of 40 mK

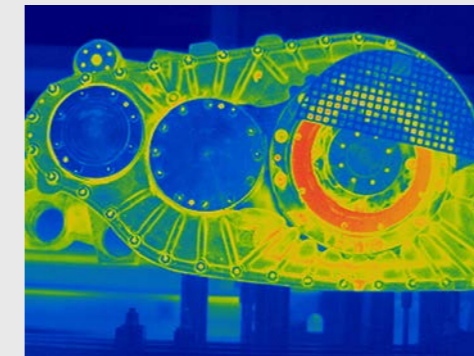

With a thermal resolution of 40 mK, the optris PI 450i is used for measuring the most subtle temperature differences, e.g. in the quality control of products or in preventive medicine.

Application example in the medical sector

Due to the very high resolution of the optris PI 450i, even veins can be made visible under the skin.

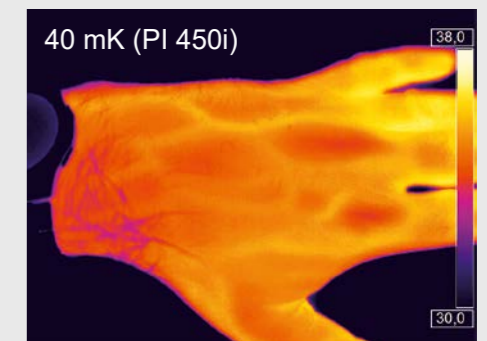
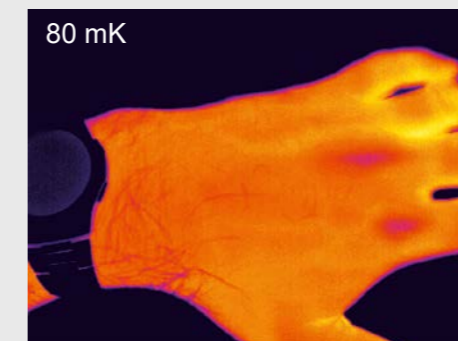

One of the most compact infrared cameras in the world

- 640 x 480 pixels
- Radiometric video recording at 32 Hz / 125 Hz in subframe-mode (640 x 120 pixels)
- Compact size of 46 x 56 x 76 – 100 mm (depending on lens)
- Lightweight (269 – 340 g, depending on lens)
- Includes license-free analysis software and full SDK

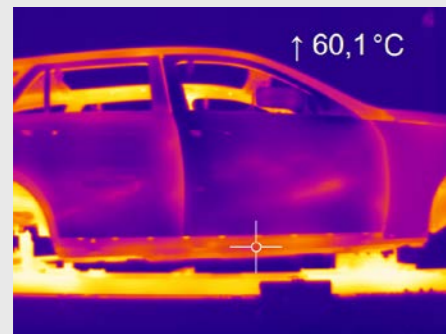
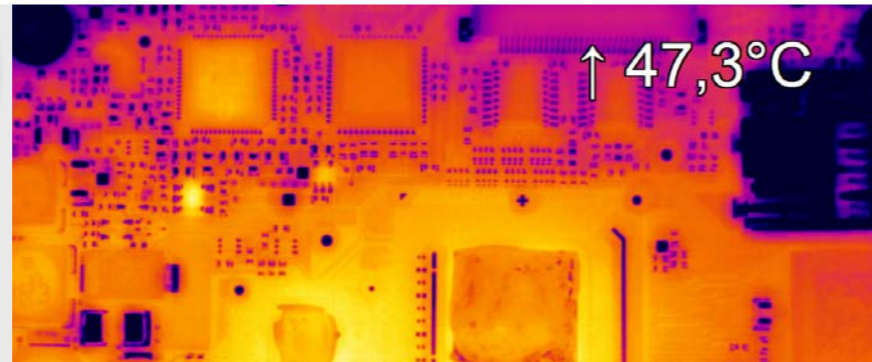

Razor sharp infrared pictures and videos for process optimization

With a casing size of only 46 x 56 x 90 mm and a weight of 320 grams (depending on lens), the optris PI 640i is among the most compact infrared cameras on the market.

The high-definition optris PI 640i infrared camera is best used in applications where finest thermal details matter.

It significantly contributes to process optimization in both research and development and in industry.

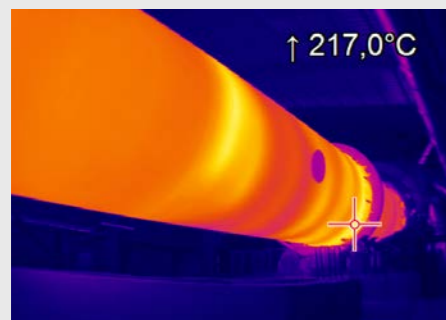
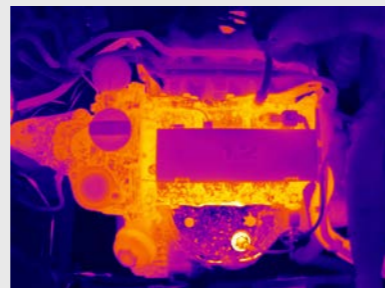

Application examples, e.g. the early detection of fires in garbage bunkers:
www.optris.com/en/industries/fire-prevention

Microscope optics for the inspection of electronic boards

- Exchangeable, focusable optics for most flexible use of the camera
- Analysis of small chip level components down to 28 µm
- Hands-free operation for simultaneous testing and IR imaging
- Frame rates up to 125 Hz allow inspection of fast processes (like pulsed laser diodes)
- Radiometric video or tiff recording with +/-2 °C measurement accuracy
- License-free analysis software and complete SDK included

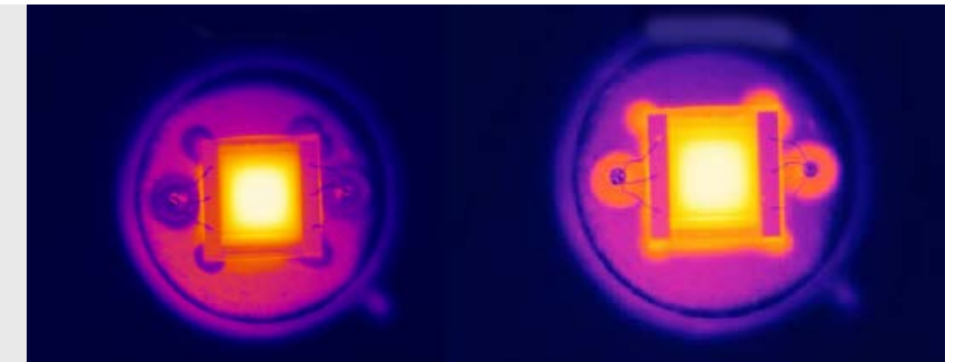

High-resolution microscope optics for test & measurement

The PI 640i can be equipped both with standard optics to image the entire circuit board and microscope optics to resolve tiny devices.

The PI 640i with microscope optics present high resolution infrared images detailing thermal variations on targets as small as 28 µm.

The high-quality thermal and geometric detail resolution of the infrared cameras ensures precise functional testing of electronic products, as even the smallest temperature differences can be accurately detected.

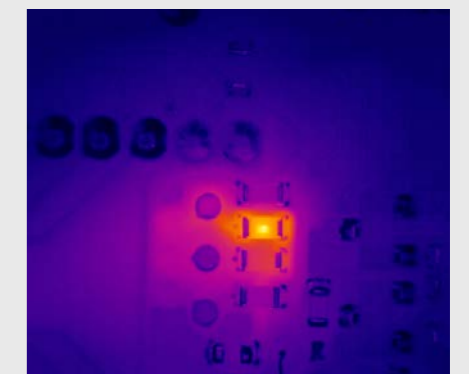
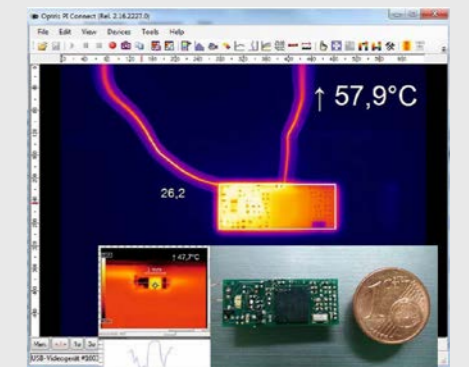

Recording of a circuit board with the optris PI 640i



Application examples for the analysis of electronic boards:
www.optris.com/en/industries/electronics

High-resolution thermography for the glass industry

- Usable at ambient temperatures of up to 70 °C without the need for additional cooling
- With an integrated filter for the spectral range of 7.9 μm
- Compact size of 46 x 56 x 76 mm
- Frame rate up to 125 Hz
- Line scan function through license-free analysis software PIX Connect
- Max. scan angle of 111 ° with 800 pixels per line

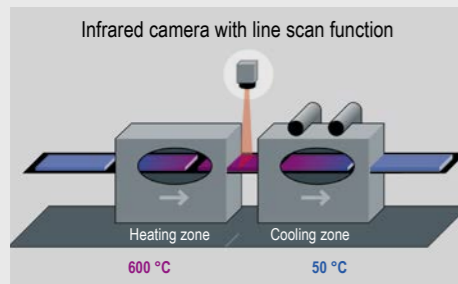

Glass tempering: Small optris IR cameras replace old bulky mechanical scanners

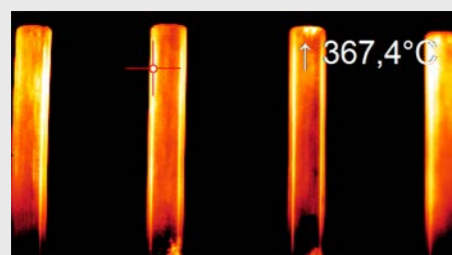

Glass tube manufacturing

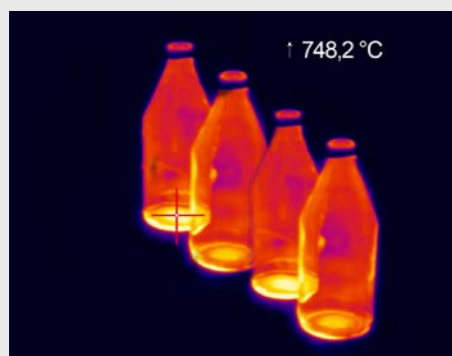

Hot-spot measurement in the production of glass bottles

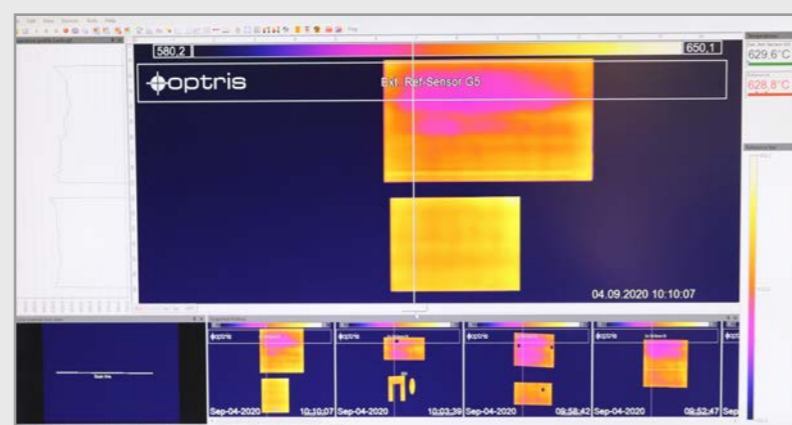

Glass panes between heating and cooling zone

Exact temperature measurements on glass surfaces via line scan camera function

Glass temperature measurements are more accurate when reflections are minimized. The optris PI 450i G7 and PI 640i G7 use an integrated 7.9 μm spectral filter to capture images and measurements where reflections are minimal. Its compact size makes the optris PI 450i/ 640i G7 particularly suitable for use in confined spaces and for installation in industrial facilities. The infrared camera is fully operational at ambient temperatures of up to 70 °C without the need for cooling. With an imaging frequency of up to 125 Hz, glass products can be continuously tested, even in fast processing.

The line scan camera function (line scan mode) of the PIX Connect software enables the exact temperature measurement of panes of glass during transport on conveyor belts. This is a particularly important quality factor in tempering processes, e.g. in ESG and VSG.



Application examples for the glass industry:
www.optris.com/en/industries/glass

Ultra-compact infrared cameras for the metal industry

- Highly dynamic CMOS detector with an optical resolution of up to 764 x 480 pixels
- Very large temperature measurement ranges (without sub-ranges) of 450 °C to 1800 °C (PI 1M), 575 °C to 1900 °C (PI 08M) and of 900 °C to 2450 °C (PI 05M)
- Frame rates and line scanning function up to 1 kHz for fast processes
- Real-time output of 8x8 pixels with 1 ms response time
- Includes license-free analysis software and full SDK
- New: PI 08M - Ideally suited for all laser processing applications with solid-state lasers in NIR through excellent blocking of radiation



Smart temperature measurement – Innovative and fast

The IR cameras optris PI 05M, PI 08M and PI 1M are specially suited for measuring the temperature of metals, as these exhibit a distinctly higher emissivity at the short measurement wavelength of 500 nm and 1 μm than at measurements in the previously conventional wavelength range of 8 – 14 μm.

Especially the spectral range of 500 nm enables for more precise measurements at changing emissivities and is less sensitive to atmospheric influences. Thus, the PI 05M is ideally suited for temperature measurements of molten metals.

A direct 1 ms analog output allows all camera models a readout of a freely selectable 8x8 pixel region in real-time. The use of these image sensors allows a large dynamic range for temperature measurement so that the previously necessary use of relatively many and narrowly defined sub-ranges is no longer required. The PI 1M, PI 08M and PI 05M's two-dimensional temperature measurement opens up new options compared to the usual spot measurement of pyrometers.

Thanks to the large measurement temperature range of 450 °C up to 2450 °C, the optris PI 05M, PI 08M and PI 1M IR camera satisfies practically all demands in the fields of metal production and processing.

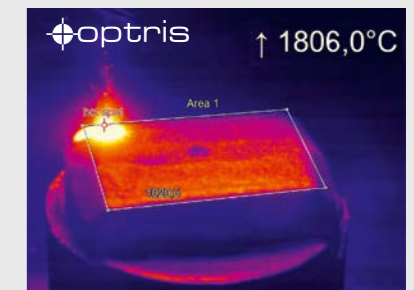

Measurement during laser welding process

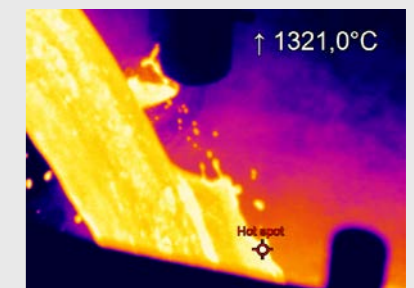

Measurement of a pouring stream

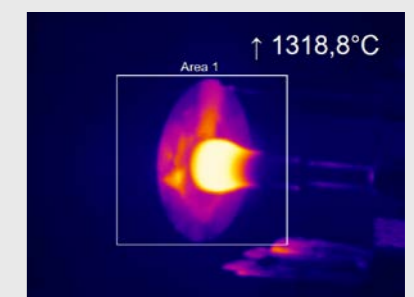

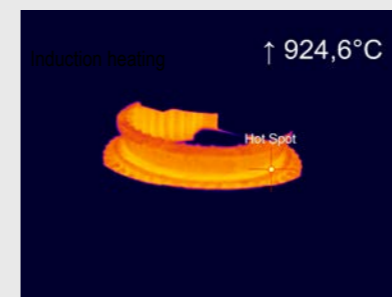

Electrical upsetting



Induction heating



Application examples for the metal industry:
www.optris.com/en/industries/metal

Infrared cameras PI series				
Basic model	PI 05M	PI 08M	PI 1M	
Detector	CMOS (15 µm pitch)	CMOS (15 µm pitch)	CMOS (15 µm pitch)	
Optical resolution	764 x 480 pixels @ 32 Hz 382 x 288 pixels @ 80 Hz (switchable to 27 Hz) 72 x 56 pixels @ 1 kHz 764 x 8 pixels @ 1 kHz (fast line scan mode)	764 x 480 pixels @ 32 Hz 382 x 288 pixels @ 80 Hz (switchable to 27 Hz) 72 x 56 pixels @ 1 kHz 764 x 8 pixels @ 1 kHz (fast line scan mode)	764 x 480 pixels @ 32 Hz 382 x 288 pixels @ 80 Hz (switchable to 27 Hz) 72 x 56 pixels @ 1 kHz 764 x 8 pixels @ 1 kHz (fast line scan mode)	
Spectral range	500 – 540 nm	780 – 820 nm	0.85 – 1.1 µm	
Temperature range	900 ... 2450 °C (27 Hz mode) 950 ... 2450 °C (32/80 Hz modes) 1100 ... 2450 °C (1 kHz mode)	575 ... 1900 °C (27 Hz mode) 625 ... 1900 °C (32 / 80 Hz mode) 750 ... 1900 °C (1 kHz mode)	450 ¹⁾ ... 1800 °C (27 Hz mode) 500 ¹⁾ ... 1800 °C (80 / 32 Hz mode) 600 ¹⁾ ... 1800 °C (1 kHz mode)	
Frame rate	Up to 1 kHz / 1 ms real time analog output (0 - 10 V) of 8 x 8 pixels (freely selectable)	Up to 1 kHz / 1 ms real time analog output (0 - 10 V) of 8 x 8 pixels (freely selectable)	Up to 1 kHz / 1 ms real time analog output (0 - 10 V) of 8 x 8 pixels (freely selectable)	
Optics (FOV) exchangeable	FOV @ 764 x 480 px: 26° x 16° (f=25 mm) FOV @ 382 x 288 px: 13° x 10° (f=25 mm)	FOV @ 764 x 480 px: 26° x 16° (f=25 mm) 39° x 25° (f=16 mm) FOV @ 382 x 288 px: 13° x 10° (f=25 mm) 20° x 15° (f=16 mm)	FOV @ 764 x 480 px: 39° x 25° (f=16 mm) 26° x 16° (f=25 mm) 13° x 8° (f=50 mm) 9° x 5° (f=75 mm) FOV @ 382 x 288 px: 20° x 15° (f=16 mm) 13° x 10° (f=25 mm) 7° x 5° (f=50 mm) 4° x 3° (f=75 mm)	
F-number	1.4	1.4	1.4 (39° and 26° lens) 2.4 (13° lens) 2.8 (9° lens)	
Thermal sensitivity NETD ²⁾	< 2 K (< 1400 °C) < 4 K (< 2100 °C)	< 2 K (< 1000 °C) < 4 K (< 1600 °C)	< 2 K (< 900 °C) < 4 K (< 1400 °C)	
System accuracy (at T _{Amb} = 23 ±5 °C)	For object temperature < 2000 °C: ±1 % of reading for 27/32/80 Hz ±1.5 % of reading for 1 kHz For object temperature > 2000 °C: ±2 % of reading for 27/32/80 Hz ±2.5 % of reading for 1 kHz	For object temperature < 1500 °C: ±1 % of reading for 27/32/80 Hz ±1.5 % of reading for 1 kHz For object temperature > 1500 °C: ±2 % of reading for 27/32/80 Hz ±2.5 % of reading for 1 kHz	For object temperature < 1400 °C: ±1 % of reading for 27/32/80 Hz ±1.5 % of reading for 1 kHz For object temperature < 1600 °C: ±2 % of reading for 27/32/80 Hz ±2.5 % of reading for 1 kHz	
PC interfaces	USB 2.0 / optional USB to GigE (PoE) interface	USB 2.0 / optional USB to GigE (PoE) interface	USB 2.0 / optional USB to GigE (PoE) interface	
Process Interface (PIF)	Standard PIF	1x 0 – 10 V input, 1x digital input (max. 24 V), 1x 0 – 10 V output	1x 0 – 10 V input, 1x digital input (max. 24 V), 1x 0 – 10 V output	1x 0 – 10 V input, 1x digital input (max. 24 V), 1x 0 – 10 V output
	Industrial PIF (optional)	2x 0 – 10 V inputs, 1x digital input (max. 24 V), 3x 0 / 4-20 mA outputs, 3x relays (0 – 30 V / 400 mA), 1x fail-safe relay	2x 0 – 10 V inputs, 1x digital input (max. 24 V), 3x 0 / 4-20 mA outputs, 3x relays (0 – 30 V / 400 mA), 1x fail-safe relay	2x 0 – 10 V inputs, 1x digital input (max. 24 V), 3x 0 / 4-20 mA outputs, 3x relays (0 – 30 V / 400 mA), 1x fail-safe relay
Ambient temperature (T _{Amb})	5 ... 50 °C	5 ... 50 °C	5 ... 50 °C	
Size	46 x 56 x 88 – 129 mm with protection tube (depending on lens and focus position)	46 x 56 x 88 – 129 mm with protection tube (depending on lens and focus position)	46 x 56 x 88 – 129 mm with protection tube (depending on lens and focus position)	
Environmental rating	IP 67 (NEMA 4)	IP 67 (NEMA 4)	IP 67 (NEMA 4)	
Weight	245 - 311 g, depending on lens	245 - 311 g, depending on lens	245 - 311 g, depending on lens	
Power supply	via USB	via USB	via USB	
Power consumption (typical values)	2.5 W	2.5 W	2.5 W	
Scope of supply (standard)	<ul style="list-style-type: none"> USB camera with 1 lens Lens tube incl. protective window USB cable (1 m) Table tripod PIF cable with terminal block (1 m) Software package optris PIX Connect Manual Aluminum case Optional: CoolingJacket, HT cable 	<ul style="list-style-type: none"> USB camera with 1 lens Lens tube incl. protective window USB cable (1 m) Table tripod PIF cable with terminal block (1 m) Software package optris PIX Connect Manual Aluminum case Optional: CoolingJacket, HT cable 	<ul style="list-style-type: none"> USB camera with 1 lens Lens tube incl. protective window USB cable (1 m) Table tripod PIF cable with terminal block (1 m) Software package optris PIX Connect Manual Aluminum case Optional: CoolingJacket, HT cable 	

1) Lenses with focal lengths f = 50 mm and f = 75 mm have an elevated starting temperature of +75 °C

2) Measurement of the noise equivalent temperature difference (NETD) according to VDI 5585 standard, method B; NETD value applies to all frame rates

Outdoor protective housing for infrared cameras	PI NetBox
part number: ACPIOPH	part number: OPTPINBW732G
Features <ul style="list-style-type: none"> Environmental rating IP 66 Additional air purge collar allows for a continuous operation in dusty and humid conditions Heating element and built-in fan enable for a 24/7 operation from -40 °C to 50 °C Installation of USB Server Gigabit 2.0 and industrial process interface possible for integration into control systems over large outdoor distances 	Features <ul style="list-style-type: none"> Miniature PC as an add-on to the PI series for stand-alone system or for cable extension via GigE Integrated hardware and software watchdog Installation of additional user software possible Status LEDs Processor: Intel® E3845 Quad Core / 1.91 GHz, 16 GB SSD, 2 GB RAM Connections: 2x USB 2.0, 1x USB 3.0, 1x Mini USB 2.0, Micro HDMI, Ethernet (Gigabit Ethernet), Micro SDHC / SDXC card Wide supply voltage range (8 – 48 V DC) or Power over Ethernet (PoE) Can be integrated into CoolingJacket Advanced
	
USB Server Gigabit 2.0 for optris PI cameras	Industrial Process Interface (PIF) for optris PI series
part number: ACPIUSBSGB	part number: ACPIIFMA
Features <ul style="list-style-type: none"> Fully USB 2.0 compatible, Data rates: 1.5 / 12 / 480 mbps, USB transfer mode: Isochronous Network connection via Gigabit Ethernet For optris PI series and Xi 400 as well as CTvideo / CSvideo series Full TCP/IP support incl. routing and DNS Two independent USB ports Supply from PoE or external power supply with 24 – 48 V DC Galvanic isolation 500 V_{RMS} (network connection) Remotely configurable via Web Based Management 	Features <ul style="list-style-type: none"> Industrial process interface for PI series with 3 analog / alarm outputs, 2 analog inputs, 1 digital input, 3 alarm relays 500 V AC_{RMS} isolation voltage between camera and process Separate fail-safe relay output PI hardware including all cable connections and PIX Connect software are permanently observed during operation
	

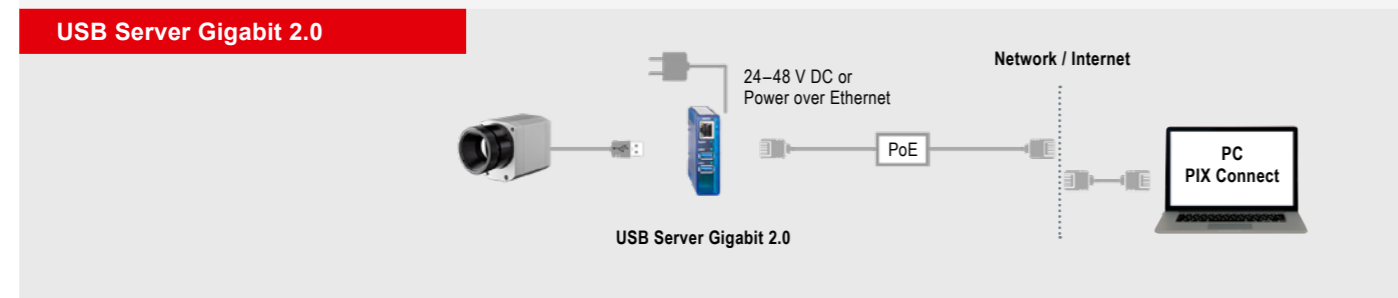
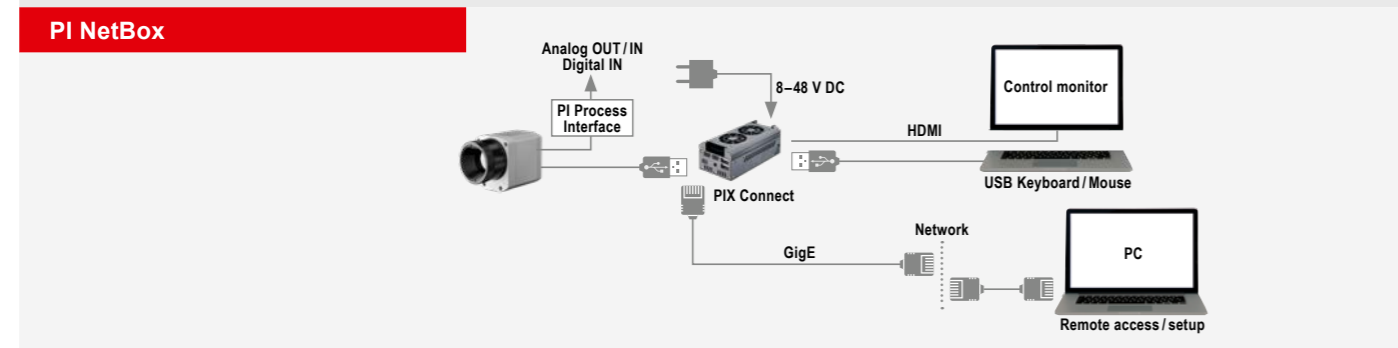
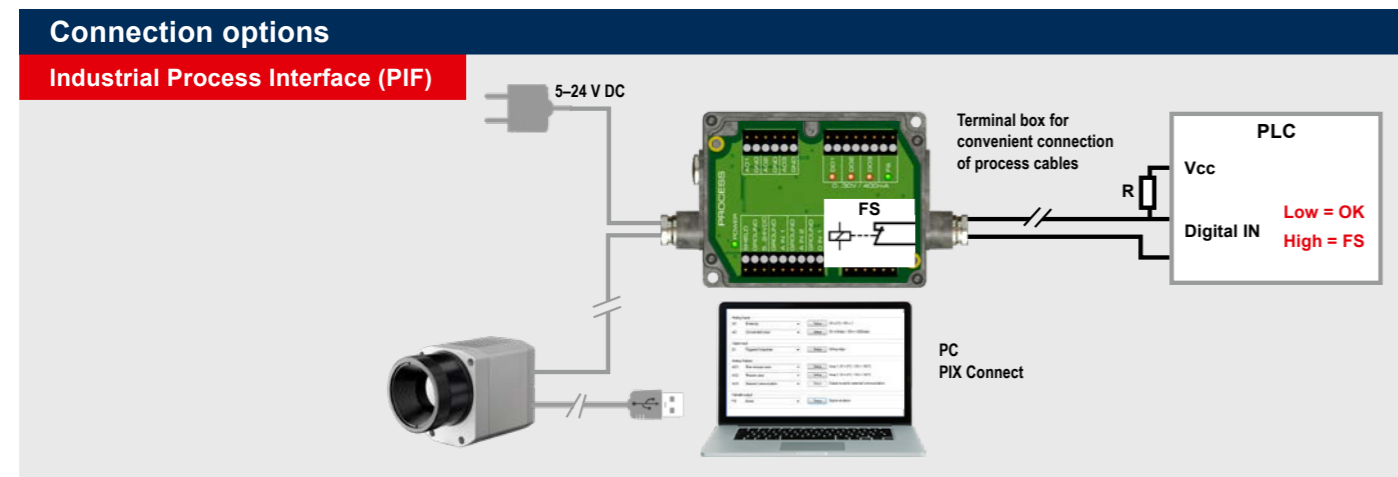

CoolingJacket Advanced	Laminar air purge
part number: ACPICJA	part number: ACCJAAPLS
Features <ul style="list-style-type: none"> • Operation at ambient temperatures up to 315 °C • Air/ water cooling with integrated air purging and optional protective windows • Modular concept for easy installation of different devices and optics • Trouble-free sensor disassembling on site with quick release chassis • Integration of additional components like PI NetBox, USB Server Gigabit 2.0 and Industrial Process Interface (PIF) in extended version 	Features <ul style="list-style-type: none"> • Protection for rugged environments • Air and water cooling, flexible laminar air stream for protection from dirt and dust • Easy maintenance due to folding mechanism • Focussable from the outside once installed • Protection window for mechanical protection integrated • Also available as line scanner version
	



Application examples for non-contact temperature measurement

The process and product temperature is an important physical indicator for manufacturing processes and ensures a high quality level of the production line.

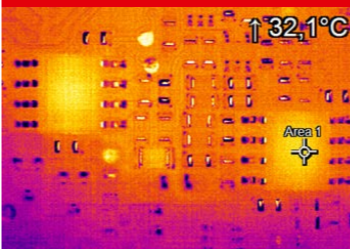
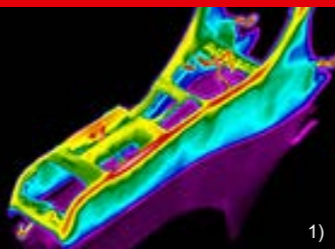
All Optris products apply in different areas, covering the non-contact temperature measurement. This covers the automotive industry, the food industry as well as 3D printing & additive manufacturing.

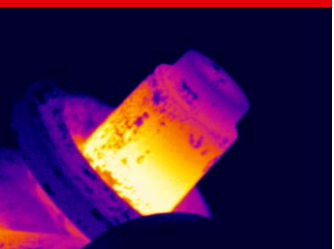
Electronics industry	Plastics industry	Fire prevention	Metal industry
			
Component inspection of circuit boards <p>More and more manufacturers of electronic circuit boards rely on noncontact temperature measurement due to the constantly increasing performance of their components.</p> <p>Recommended devices: PI 640i Microscope optics, Xi 400 Microscope optics</p>	Injection molding <p>In order to prevent component distortion during injection molding, the process is monitored by thermal imaging cameras detecting and adjusting temperature over- or undershoots during molded part measurement.</p> <p>Recommended device: PI 450i</p>	Infrared technology in waste processing <p>Early fire detection with infrared cameras is an important protective measure in industry to prevent irreparable damage to industrial plants and buildings.</p> <p>Recommended device: Xi 400</p>	Workpiece control during drop forging <p>In drop forging, the semi-finished products must be at a certain forging temperature before forming. In order to achieve the optimum production result, the surface temperature of the material is controlled accordingly.</p> <p>Recommended devices: PI 1M, PI 05M</p>

References: 1) GTT Willi Steinko

Further information see our application brochures:



Metal

www.optris.com/en/industries/metal



Plastics

www.optris.com/en/industries/plastics



Glass

www.optris.com/en/industries/glass

Industries	Application notes	More infos
Fire prevention / Safety	Battery monitoring with IR temperature measurement	www.optris.com/en/industries/fire-prevention/battery-production-and-development
	Early fire detection with infrared cameras	www.optris.com/en/support/articles-stories/iris-gmbh
	Infrared cameras monitor planing systems - from fire protection to quality control	www.optris.com/en/support/articles-stories/case-study/binderholz-gmbh
Electric utility sector	Web Access Converter Module	www.optris.com/en/industries/electric-utility-sector

FEATURES

Comprehensive IR camera software

- No additional costs or licensing restrictions
- Modern software with intuitive user interface
- Remote control of camera
- Display of numerous images in different windows
- Compatible with Windows 7, 8, 10 and 11
- Two Software Development Kits for Windows and Linux included
- Various language options, incl. translation function
- Temperature display in °C or in °F

Temperature information in main window, as digital display or as graphic

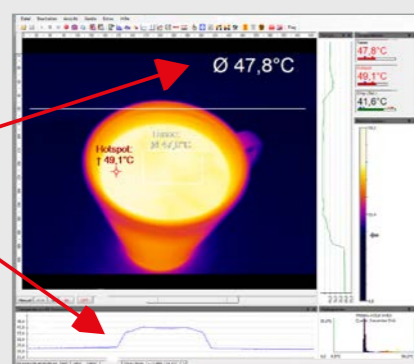

Our layouts – as individual as your applications

Pre-defined layouts make it quick and easy to start with your applications. And because we know that every measurement task has its own individual requirements, we have ensured that it is quite easy to adapt the pre-set layout to suit your individual requirements.

The user interface of the PIX Connect software can also be adapted to suit your personal workflow: Software windows can be easily arranged using drag & drop; in the toolbar you can save shortcuts for functions relevant to your application – or even remove links which you do not need.

Regardless of whether you are working on a desktop PC or a tablet, the user interface can be adapted.

The PIX Connect software makes a wide range of preset color palettes available. This allows optimal depiction of thermal contrasts. The pre-defined color palettes can be individually adapted to be able to cater for the specific requirements of your respective application.

Associated temperature groups (isotherms) can be identified by color markers and highlighted.

It is also possible to define temperature values in advance; pixels above, below, or between these values are highlighted in color.

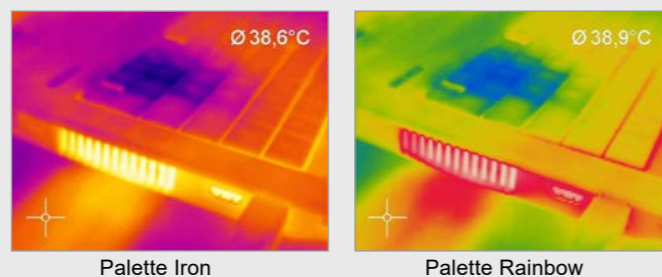

The right color palette for every application

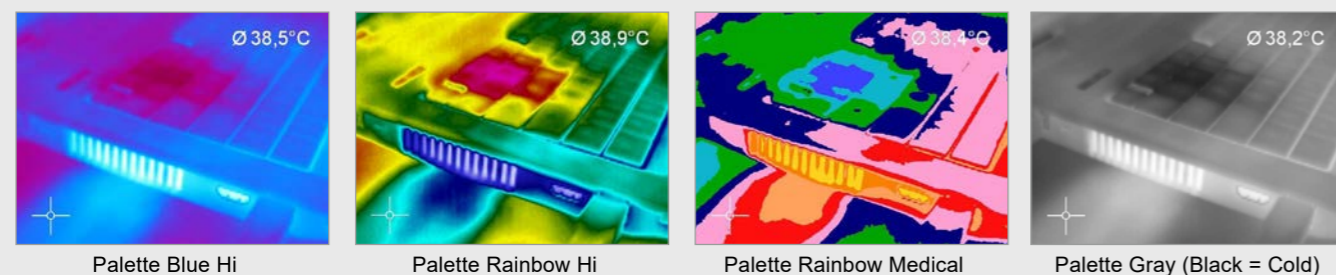

Measuring areas

It is not just a matter of size, but also depends on the content: designing a suitable measurement area

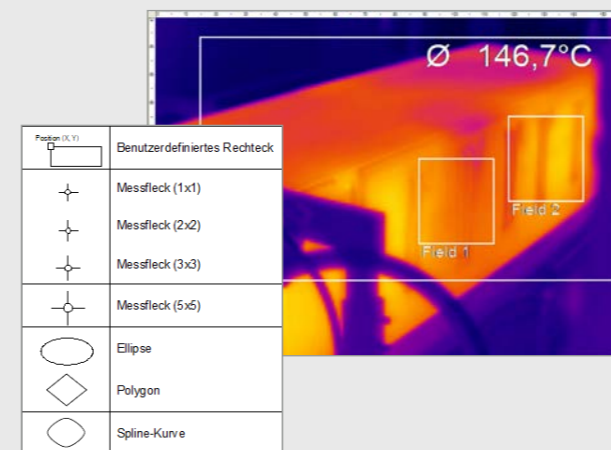

The size and shape of measurement area can be freely designed and moved. For an easy introduction, a large selection of pre-defined measurement area shapes is available.

You can set up as many measurement areas as you like in the camera's field of view. To do this, it is possible to make a distinction between main and ancillary fields.

Various modes can be set in a measurement area, such as minimum value, maximum value, or average value, or you can rule out the detection of hot or cold spots.

The separate setting of the emissivity for measurement areas allows various material surfaces to be monitored with a single camera.

Differences and averaging between different measurement areas are easy to calculate with the PIX Connect software.

Saved measurement areas can be displayed as an image, a digital display or a diagram and can then be saved for further analysis.

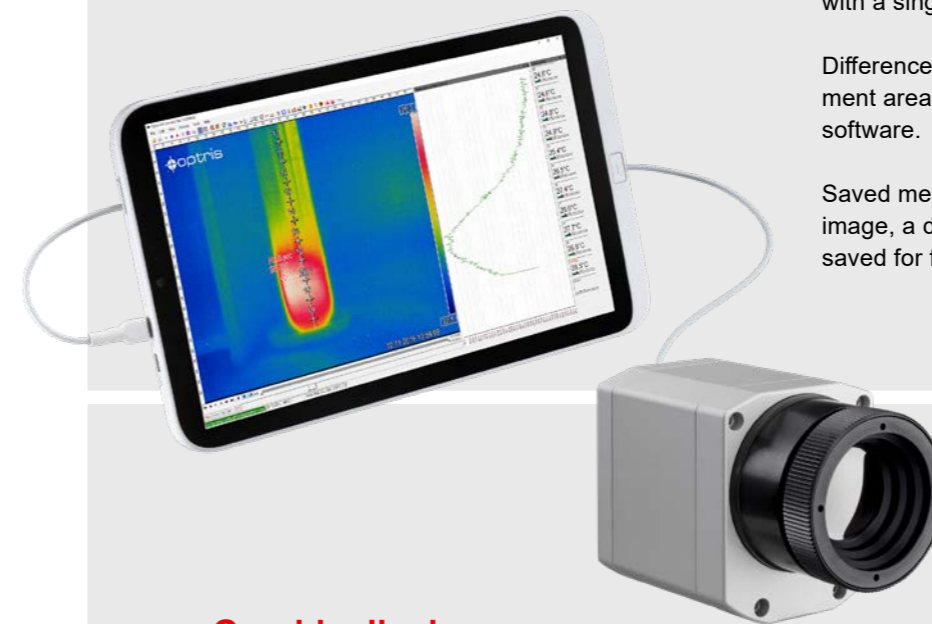

Graphic display of the temperature values

Temperature values can be shown along a straight line as temperature profiles as well as as 3D diagrams.

A temperature/time diagram can be used to analyze the temperature development over time. Individual time sections can be lifted out of the diagram and be analyzed in detail by zooming in and out.

Diagrams defined in this way can be exported from the software and be saved in Excel for further analysis.

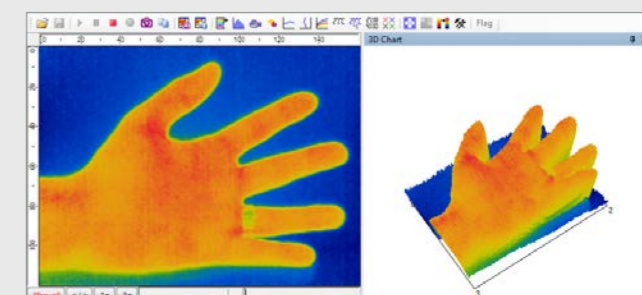
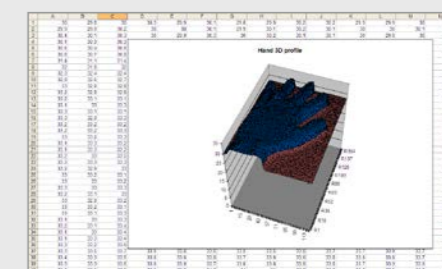

Recording and display

Recording video sequences – for later analysis and documentation

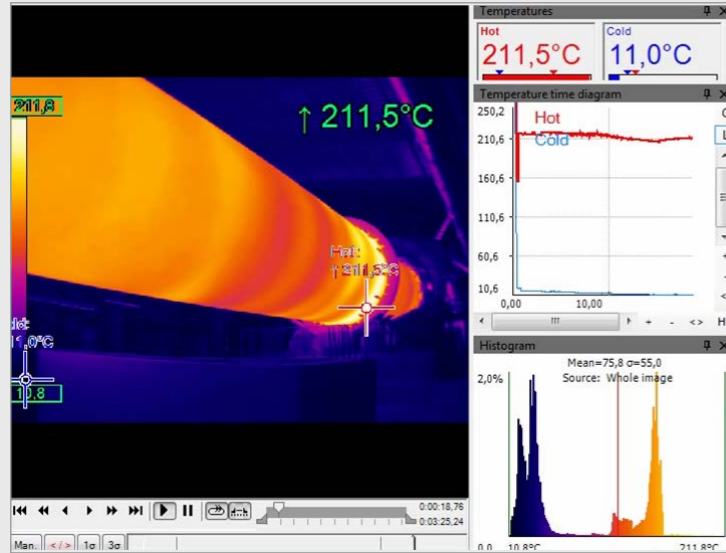

Beside of single snapshots also video recordings can be made with the software, both with radiometric data included. This allows a detailed analysis of the measurement results afterwards.

An integrated screen capture function makes it simple to retrospectively generate videos in wmv format.

Videos recorded can be processed retrospectively. For example, individual sections can be cut out of a recording and can be saved as an independent sequence.

Saved video recordings are available for analysis. The sequences can be played back in slow motion or time lapse for this purpose. It is also possible to play back as a continuous loop.

Event grabber

The snapshot option works like a screenshot; an individual image is recorded from the live picture. This snapshot is a radiometric image (*.tiff), where all the temperature and measurement area information at the time of the recording is saved for every pixel.

Saving and exporting the image for further analysis in Excel is possible thanks to the option of saving the temperature matrix in text format, e.g. as comma-separated values (.csv format). It is also possible to continue processing the image data with standard programs such as Photoshop or Windows Media Player.

Sections of the saved image can be zoomed in to get a closer look. 3D display is also possible.

Snapshots – all temperature information in one picture

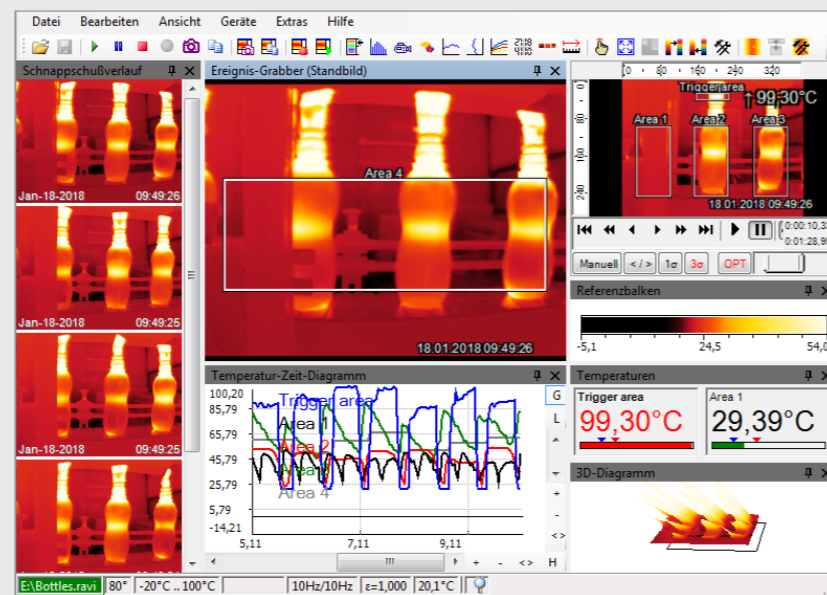

Merging

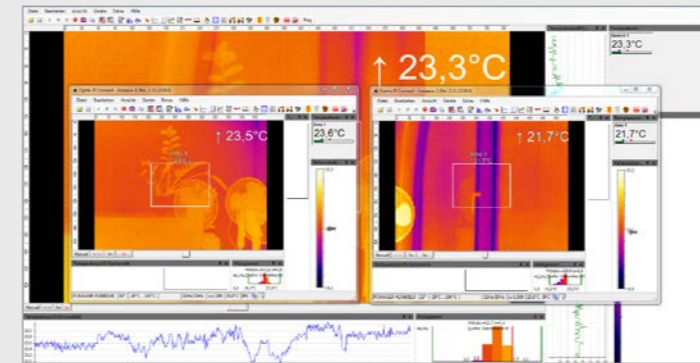

The fields of vision of three cameras (top) are converted into one single image via the merging function. (bottom)



The merging function combines several camera angles together in a single picture

The PIX Connect software gives you the option of grouping together several cameras within a software instance, i.e. the field of view of several infrared cameras are merged together to make a single picture. For processes with several control points in particular, it is helpful to concentrate the various angles on one screen. Merging several cameras also makes it possible to get an all-round view of a 3D object.

You can merge several cameras either using a direct USB connection or via Ethernet. While in the first case, every camera needs to have its own USB port; for the second option, one Ethernet connection is enough. The cameras here are each connected to the Ethernet switch on the PC via a USB Server Gigabit 2.0.

Alarms

Defining several alarm values – allows quick intervention

Alarms for freely definable measurement areas, calculated objects, uncommitted values of external transmitters as well as the internal temperature of the camera can be chosen via the software. Apart from minimum and maximum values, it is also possible to set so-called advance alarms. These will emit a warning when the measured temperature approaches the defined minimum or maximum value, therefore giving you more options and time to react.

If the measured temperature reaches one of the previously defined values, then the software will trigger an alarm which can be forwarded to a PLC via the process interface. In addition to that, the critical event can be easily documented as a snapshot or video recording and be used for analysis later on.

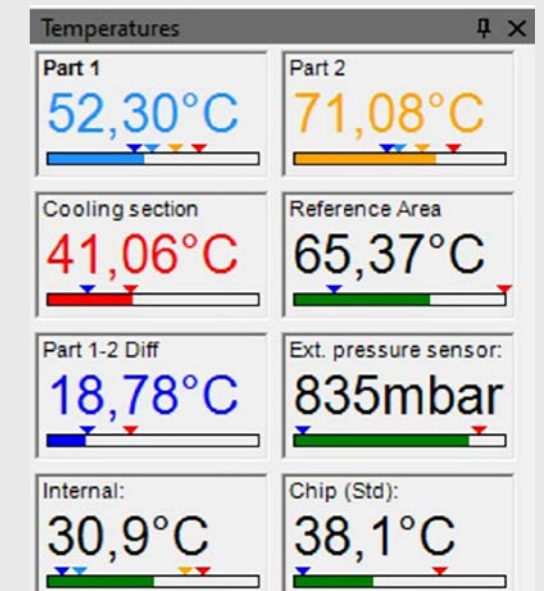

For the measurement of moving objects

The optris PIX Connect software is equipped with a **line scan camera function**.

The line scanner is primarily used for processes involving moving measurement objects, like **rotary kiln measurements** or large quantities on conveyor belts (**batch process**).

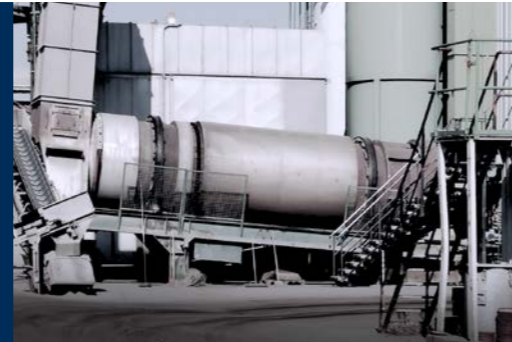

Application example: rotary kiln in the chemical industry

The advantages

Simple monitoring of processes with limited visual access

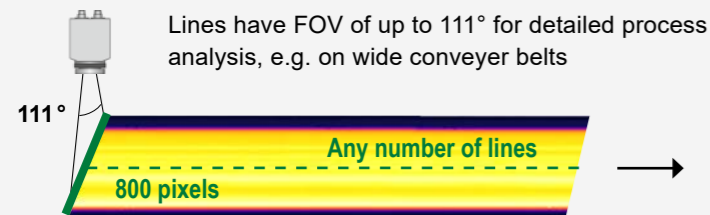
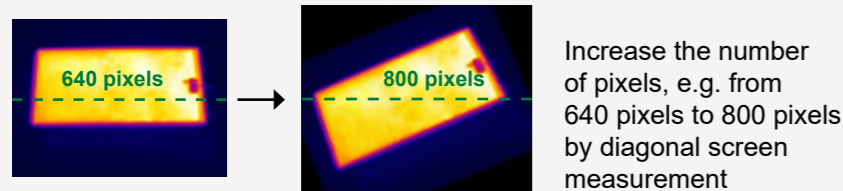
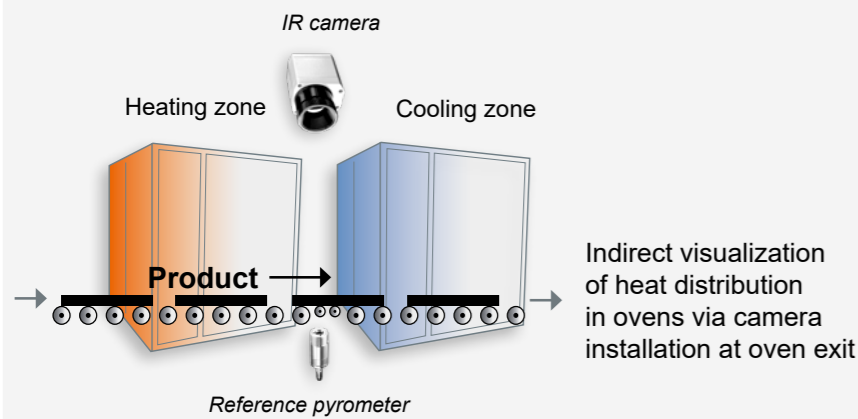

Up to 32 Hz data recording* of unlimited lines which in turn produce a thermal image of any given resolution.

*Up to 125 Hz data recording when using 90° in subframe mode (640 x 120px)

Only 3 steps to initialize the function

Step 1

Activation of the line scan camera function (continuous, self-triggered, external trigger) and definition of the position of the lines in the thermal image. For this the camera itself serves as an orientation aid.

Step 2

Configuration of line scan function, e.g. number of lines displayed or set trigger for automatic saving of images.

Step 3

Definition of individual layouts, e.g. display of saved images in the snapshot process.

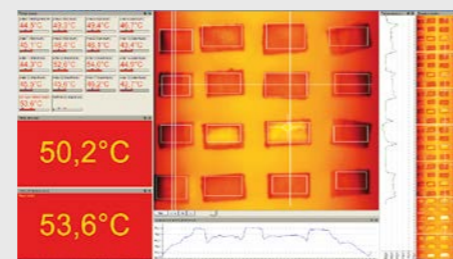

Layout example for display of line scan camera function

For more software tutorials watch our **YouTube** – Channel

or visit our website:

www.optris.com/en/support/videos/software-tutorials



Glass inspection system for process control in glass tempering machines



New

With the new glass inspection system, temperature differences during glass hardening processes can be quickly detected, thus avoiding rejects and providing automatic quality monitoring.

The Top Down GIS 640 R system with temperature referencing by means of a sensor from below as well as automatic emissivity correction for standard and low-E glasses was specially developed for process control in glass tempering machines.



Measurement principle

A variety of optics with different field of views allows an optimal mounting of the camera at a larger distance (no cooling needed) and avoids influences by the angle dependent emissivity.

Positioning of IR camera and reference pyrometer in a Top Down Glass Inspection System.

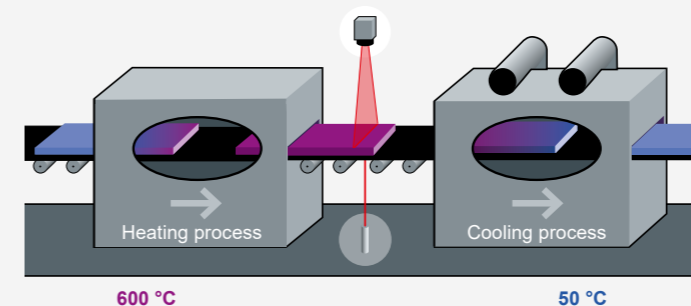

PIX Connect Software

Comprehensive IR camera software without licensing restrictions and with intuitive user interface.



Monitoring temperatures of glass sheets

Important specifications

- Top down system with additional reference pyrometer from underneath for automatic emissivity correction
- Digitally controlled lens protection system (DCLP) avoids extra air purging
- Glass area calculation
- Pre-assembled system for easy installation on glasstempering furnaces
- Automatic scan line adjustment – insensitive to distortions



Tool for all optris infrared cameras



- The cameras of the PI series have a direct connection to an android smartphone or tablet
- IRmobile App downloadable for free from the Google Play Store
- For connection to the device the IR App Connector is recommended

Xi 80 / 410 Part number: ACXI80IACM (Micro-USB) or ACXI80IACC (USB-C)

Xi 400 Part number: ACPIIACM (Micro-USB) or ACPIIACC (USB-C)

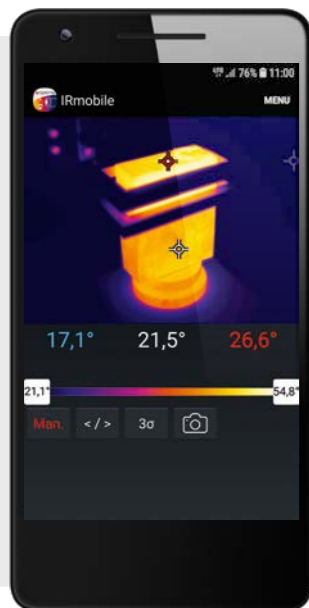

IRmobile app features:

- Live IR image with automatic hot and cold spot search
- Taking snapshots and analyze them later with PIX Connect software
- Adjustable camera features like temperature measuring range, frame rate and selectable color palettes
- Changing the temperature unit: Celsius or Fahrenheit
- Integrated simulator

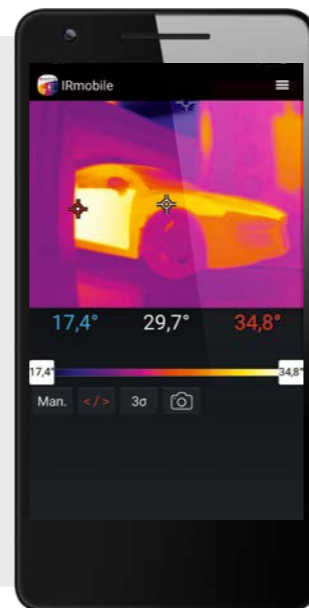

Supported for

- PI and Xi series and all pyrometers
- For android devices from version 5.0 or higher with micro-USB or USB-C connectors that support USB OTG

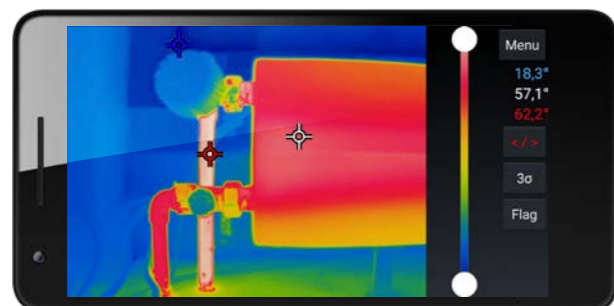

Precise measuring at various distances

A choice of lenses allows you to precisely measure objects at various distances, from close and standard distances right up to large distances. The IR cameras of the optris PI series allow for changing between several lenses.

With infrared cameras there are various parameters which display the relationship between the distance from the measuring object and the size of the pixel on the object plane. In choosing the correct lens, the following should be taken into account:

- HFOV** Horizontal expansion of the total measuring field on the object plane
- VFOV** Vertical expansion of the total measuring field on the object plane
- IFOV** Size of individual pixels on the object plane
- DFOV** Diagonal expansion of the total measuring field on the object plane
- MFOV** Recommended, smallest measuring object size of 3 x 3 pixels or 2 x 2 pixels when using the PI microscope optics or the Xi 80, respectively

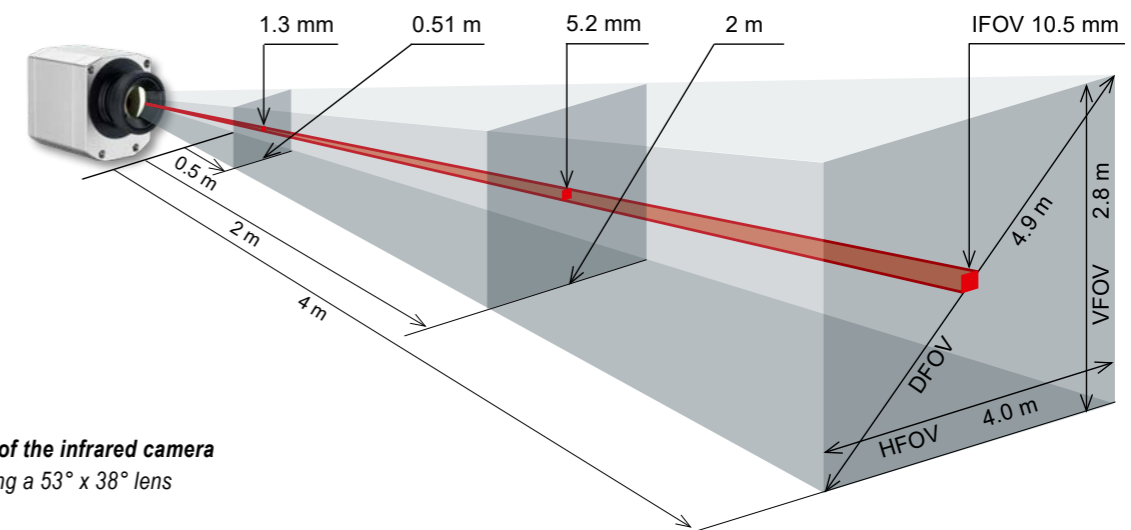

Measuring field of the infrared camera
optris PI 450i using a 53° x 38° lens

Optris Calculator

Combines the measuring spot size calculator of the IR pyrometers and the optics calculator of the IR cameras

The measuring spot size of the respective device is calculated for each distance



Pyrometers

- The spot size calculator determines the exact spot size for all sensor / optics combinations for any entered distance
- For reliable measurements

IR cameras

- Based on camera / lens combination and the distance to the object, the measuring field dimensions and pixel size are calculated precisely.
- Ensures an optimal positioning of the camera and the avoidance of measuring errors

Features

- Calculates for each distance the measuring spot size of the respective device
- Always the current software and features through regular updates



Supported for

- All android devices (5.0 or higher)



OPTICS

Xi 80	Focal length [mm]	Minimum measurement distance*	Angle	Distance to measurement object [m]												
					0.05	0.1	0.2	0.3	0.5	1	2	4	6	10	30	100
80 x 80 px	5	0.2 m	30°	HFOV [m]	0.028	0.056	0.11	0.17	0.28	0.56	1.1	2.2	3.3	5.6	16.7	55.8
			30°	VFOV [m]	0.028	0.056	0.11	0.17	0.28	0.56	1.1	2.2	3.3	5.6	16.7	55.8
			43°	DFOV [m]	0.039	0.079	0.16	0.24	0.39	0.79	1.58	3.15	4.7	7.9	23.7	78.9
			7 mrad	IFOV [mm]	0.3	0.7	1.4	2.1	3.5	7.0	13.9	27.9	41.8	69.7	209.2	697.1
F13 Telephoto lens	13	0.3 m	12°	HFOV [m]	0.022	0.043	0.065	0.11	0.21	0.43	0.85	1.28	2.1	6.4	21.3	
			12°	VFOV [m]	0.022	0.043	0.065	0.11	0.21	0.43	0.85	1.28	2.1	6.4	21.3	
			17°	DFOV [m]	0.031	0.061	0.092	0.15	0.30	0.60	1.20	1.81	3.0	9.0	30.1	
			2.7 mrad	IFOV [mm]	0.3	0.5	0.8	1.3	2.7	5.3	10.6	16.0	26.6	79.8	266	
F03 Wide angle lens	3	0.2 m	55°	HFOV [m]	0.057	0.11	0.21	0.32	0.52	1.04	2.1	4.1	6.2	10.4	31.1	103.7
			55°	VFOV [m]	0.057	0.11	0.21	0.32	0.52	1.04	2.1	4.1	6.2	10.4	31.1	103.7
			77°	DFOV [m]	0.081	0.15	0.30	0.45	0.74	1.47	2.9	5.9	8.8	14.7	44.0	146.6
			13 mrad	IFOV [mm]	0.7	1.4	2.7	3.9	6.5	13.0	25.9	51.7	77.8	129.7	388.9	1296
F02 Super wide angle lens	2	0.2 m	80°	HFOV [m]	0.089	0.17	0.34	0.51	0.85	1.69	3.4	6.7	10.1	16.9	50.7	169.0
			80°	VFOV [m]	0.089	0.17	0.34	0.51	0.85	1.69	3.4	6.7	10.1	16.9	50.7	169.0
			113°	DFOV [m]	0.126	0.24	0.49	0.72	1.2	2.4	4.8	9.5	14.3	23.9	71.7	239.0
			21 mrad	IFOV [mm]	1.1	2.2	4.3	6.4	10.6	21.2	42.2	84.3	126	211	634	2113

Xi 410	Focal length [mm]	Minimum measurement distance*	Angle	Distance to measurement object [m]												
					0.05	0.1	0.2	0.3	0.5	1	2	4	6	10	30	100
384 x 240 px	13	0.35 m	29°	HFOV [m]	0.059	0.112	0.17	0.27	0.53	1.07	2.1	3.2	5.3	15.9	52.9	
			18°	VFOV [m]	0.036	0.068	0.10	0.16	0.32	0.64	1.3	1.9	3.2	9.5	31.7	
			35°	DFOV [m]	0.069	0.131	0.19	0.32	0.62	1.24	2.5	3.7	6.2	18.5	61.6	
			1.4 mrad	IFOV [mm]	0.2	0.3	0.4	0.7	1.4	2.8	5.5	8.3	13.8	41.3	137.7	
F20 Telephoto lens	20	0.35 m	18°	HFOV [m]	0.069	0.102	0.17	0.33	0.66	1.31	2.0	3.3	9.8	32.6		
			12°	VFOV [m]	0.043	0.064	0.10	0.21	0.41	0.82	1.2	2.1	6.1	20.5		
			21°	DFOV [m]	0.081	0.120	0.20	0.39	0.78	1.55	2.3	3.9	11.5	38.5		
			0.9 mrad	IFOV [mm]	0.2	0.3	0.4	0.9	1.7	3.4	5.1	8.5	25.5	84.8		
F08 Wide angle lens	8	0.25 m	53°	HFOV [m]	0.100	0.20	0.30	0.49	0.99	2.0	4.0	5.9	9.9	29.7	98.9	
			31°	VFOV [m]	0.057	0.11	0.17	0.28	0.55	1.1	2.2	3.3	5.5	16.5	54.9	
			61°	DFOV [m]	0.115	0.23	0.34	0.57	1.13	2.3	4.5	6.8	11.3	33.9	113.1	
			2.6 mrad	IFOV [mm]	0.3	0.5	0.8	1.3	2.6	5.1	10.3	15.5	25.8	77.2	257.4	
F06 Super wide angle lens	6	0.2 m	80°	HFOV [m]	0.084	0.16	0.32	0.48	0.81	1.6	3.3	6.5	9.8	16.6	49.9	166.4
			44°	VFOV [m]	0.044	0.08	0.17	0.25	0.41	0.8	1.6	3.2	4.8	8.0	24.1	80.4
			91°	DFOV [m]	0.095	0.18	0.36	0.54	0.91	1.8	3.6	7.3	10.9	18.5	55.4	184.8
			4.3 mrad	IFOV [mm]	0.2	0.4	0.8	1.3	2.1	4.2	8.5	16.9	25.5	43.4	130.0	433.2

Xi 400	Focal length [mm]	Minimum measurement distance*	Angle	Distance to measurement object [m]												
					0.05	0.1	0.2	0.3	0.5	1	2	4	6	10	30	100
382 x 288 px	13	0.35 m	29°	HFOV [m]	0.059	0.111	0.16	0.27	0.53	1.06	2.1	3.2	5.3	15.8	52.5	
			22°	VFOV [m]	0.043	0.082	0.12	0.20	0.39	0.78	1.5	2.3	3.9	11.6	38.5	
			37°	DFOV [m]	0.073	0.138	0.20	0.34	0.66	1.31	2.6	3.9	6.5	19.5	65.1	
			1.5 mrad	IFOV [mm]	0.2	0.3	0.4	0.7	1.4	2.8	5.5	8.3	13.8	41.2	137.4	
F20 Telephoto lens	20	0.35 m	18°	HFOV [m]	0.069	0.102	0.17	0.33	0.66	1.30	1.9	3.2	9.7	32.4		
			14°	VFOV [m]	0.051	0.076	0.12	0.25	0.49	0.98	1.5	2.5	7.4	24.6		
			23°	DFOV [m]	0.086	0.127	0.21	0.41	0.82	1.63	2.4	4.1	12.2	40.7		
			0.9 mrad	IFOV [mm]	0.2	0.3	0.4	0.9	1.7	3.4	5.1	8.5	25.4	84.8		
F08 Wide angle lens	8	0.25 m	53°	HFOV [m]	0.099	0.20	0.30	0.49	0.99	2.0	4.0	5.9	9.9	29.6	98.6	
			38°	VFOV [m]	0.071	0.14	0.21	0.34	0.68	1.4	2.7	4.1	6.8	20.4	68.1	
			65°	DFOV [m]	0.122	0.25	0.36	0.60	1.20	2.4	4.8	7.2	12.0	36.0	119.9	
			2.6 mrad	IFOV [mm]	0.26	0.53	0.78	1.3	2.6	5.2	10.4	15.5	25.9	77.5	258.2	
F06 Super wide angle lens	6	0.2 m	80°	HFOV [m]	0.084	0.16	0.32	0.48	0.81	1.6	3.3	6.5	9.8	16.6	49.9	166.4
			54°	VFOV [m]	0.056	0.11	0.21	0.31	0.51	1.0	2.0	4.1	6.1	10.2	30.6	101.9
			96°	DFOV [m]	0.101	0.19	0.38	0.57	0.96	1.9	3.8	7.7	11.6	19.5	58.5	195.1
			4.3 mrad	IFOV [mm]	0.2	0.4	0.8	1.3	2.1	4.2	8.5	17.0	25.7	43.6	130.7	435.5

PI 400i / 450i PI 450i G7	Focal length [mm]	Minimum measurement distance*	Angle	Distance to measurement object [m]												
					0.05	0.1	0.2	0.3	0.5	1	2	4	6	10	30	100
382 x 288 px	13	0.35 m	29°	HFOV [m]	0.060	0.11	0.17	0.27	0.53	1.06	2.1	3.2	5.3	15.8	52.5	
			22°	VFOV [m]	0.044	0.083	0.12	0.20	0.39	0.78	1.5	2.3	3.9	11.6	38.5	
			37°	DFOV [m]	0.075	0.14	0.21	0.34	0.66	1.31	2.6	3.9	6.5	19.5	65.1	
			1.4 mrad	IFOV [mm]	0.2	0.3	0.4	0.7	1.4	2.8	5.5	8.3	13.8	41.2	137.4	
O18 Telephoto lens	20	0.5 m	18°	HFOV [m]	0.102	0.16	0.33	0.66	1.3	2.0	3.3	9.8	32.5			
			14°	VFOV [m]	0.076	0.13	0.25	0.50	1.0	1.5	2.5	7.4	24.7			
			23°	DFOV [m]	0.127	0.21	0.41	0.83	1.6	2.5	4.1	12.3	40.9			
			0.9 mrad	IFOV [mm]	0.3	0.4	0.86	1.7	3.4	5.1	8.5	25.6	85.2			
O53 Wide angle lens	8	0.25 m	53°	HFOV [m]	0.059	0.107	0.21	0.31	0.51	1.01	2.0	4.0	6.0	10.0	29.9	99.5
			38°	VFOV [m]	0.041	0.076	0.14	0.21	0.35	0.70	1.4	2.8	4.2	6.9	20.8	69.2
			65°	DFOV [m]	0.072	0.131	0.25	0.37	0.62	1.23	2.4	4.9	7.3	12.1	36.4	121.2
			2.7 mrad	IFOV [mm]	0.2	0.3	0.5	0.8	1.3	2.6	5.2	10.5	15.7	26.1	78.2	260.5
O80 Super wide angle lens	6	0.2 m	80°	HFOV [m]	0.093	0.17	0.33	0.49	0.81	1.6	3.2	6.5	9.8	16.6	49.9	166.4
			54°	VFOV [m]	0.059	0.11	0.21	0.31	0.52	1.0	2.0	4.1	6.1	10.2	30.6	101.9
			96°	DFOV [m]	0.110	0.21	0.39	0.58	0.96	1.9	3.8	7.7	11.6	19.5	58.5	195.1
			4.2 mrad	IFOV [mm]	0.2	0.5	0.9	1.3	2.1	4.2	8.5	17.0	25.7	43.6	130.7	435.5

Table with examples showing which measurement field sizes and pixel sizes will be reached at which distance. For optimal configuration of the camera there are various lenses available. Wide angle lenses have radial distortion due to the angle of their aperture. The PIX Connect software has an algorithm which corrects this distortion.

*Please note: Please use the optics calculator on our website in order to calculate measurement fields with shorter measurement distances:

www.optris.com/en/optris-calculator

The measurement accuracy of the camera may lie outside of the specifications for distances below the defined minimum measurement distance.

Table with examples showing which measurement field sizes and pixel sizes will be reached at which distance. For optimal configuration of the camera there are various lenses available. Wide angle lenses have radial distortion due to the angle of their aperture. The PIX Connect software has an algorithm which corrects this distortion.

*Please note: Please use the optics calculator on our website in order to calculate measurement fields with shorter measurement distances:

www.optris.com/en/optris-calculator

The measurement accuracy of the camera may lie outside of the specifications for distances below the defined minimum measurement distance.

OPTICS

PI 640i / PI 640i G7	Focal length [mm]	Minimum measurement distance*	Angle	Distance to measurement object [m]												
				0.05	0.1	0.2	0.3	0.5	1	2	4	6	10	30	100	
O33 Standard lens	19	0.3 m	33°	HFOV [m]		0.064	0.12	0.18	0.30	0.60	1.20	2.4	3.6	6.0	17.9	59.7
			25°	VFOV [m]		0.047	0.09	0.14	0.23	0.45	0.9	1.8	2.7	4.5	13.4	44.5
			42°	DFOV [m]		0.079	0.15	0.23	0.38	0.75	1.5	3.0	4.5	7.5	22.4	74.5
			0.9 mrad	IIFOV [mm]		0.1	0.2	0.3	0.5	0.9	1.9	3.7	5.6	9.3	28.0	93.3
O15 Telephoto lens	42	0.5 m	15°	HFOV [m]					0.14	0.27	0.53	1.0	1.6	2.6	7.8	26.2
			11°	VFOV [m]					0.10	0.20	0.40	0.8	1.2	2.0	5.9	19.6
			19°	DFOV [m]					0.17	0.33	0.66	1.3	2.0	3.3	9.8	32.7
			0.4 mrad	IIFOV [mm]					0.2	0.4	0.8	1.6	2.4	4.1	12.3	40.9
O60 Wide angle lens	11	0.2 m	60°	HFOV [m]	0.07	0.13	0.24	0.35	0.60	1.2	2.3	4.7	7.0	11.7	34.9	116.4
			45°	VFOV [m]	0.05	0.09	0.17	0.26	0.42	0.8	1.7	3.3	5.0	8.3	24.9	82.9
			75°	DFOV [m]	0.09	0.16	0.30	0.44	0.73	1.4	2.9	5.7	8.6	14.3	42.9	142.9
			1.9 mrad	IIFOV [mm]	0.1	0.2	0.4	0.6	0.9	1.8	3.7	7.3	10.9	18.2	54.6	182
O90 Super wide angle lens	8	0.2 m	90°	HFOV [m]	0.11	0.22	0.42	0.62	1.0	2.0	4.0	8.1	12.1	20.2	60.4	201.4
			64°	VFOV [m]	0.07	0.14	0.26	0.39	0.6	1.3	2.5	5.0	7.6	12.6	37.7	125.7
			110°	DFOV [m]	0.14	0.26	0.49	0.73	1.2	2.4	4.8	9.5	14.2	23.8	71.3	237.4
			3.2 mrad	IIFOV [mm]	0.2	0.3	0.7	1.0	1.6	3.2	6.3	12.6	18.9	31.5	94.4	315

PI 1M / PI 08M / PI 05M	Focal length [mm]	Minimum measurement distance*	Angle	Distance to measurement object [m]												
				0.1	0.2	0.3	0.5	1	2	4	6	10	30	100		
OF16 Wide angle lens	16	0.2 m	39°	HFOV [m]		0.14	0.21	0.36	0.72	1.43	2.87	4.30	7.2	21.5	71.6	
			25°	VFOV [m]		0.09	0.14	0.23	0.45	0.90	1.80	2.70	4.5	13.5	45.0	
			46°	DFOV [m]		0.17	0.25	0.42	0.85	1.69	3.38	5.08	8.5	25.4	84.6	
			0.94 mrad	IIFOV [mm]		0.2	0.3	0.5	0.9	1.9	3.8	5.6	9.4	28.1	93.8	
OF25 Standard lens	25	0.5 m	26°	HFOV [m]	0.046	0.09	0.14	0.23	0.46	0.92	1.83	2.75	4.6	13.8	45.8	
			16°	VFOV [m]	0.029	0.06	0.09	0.14	0.29	0.58	1.15	1.73	2.9	8.6	28.8	
			30°	DFOV [m]	0.054	0.11	0.16	0.27	0.54	1.08	2.17	3.25	5.4	16.2	54.1	
			0.60 mrad	IIFOV [mm]	0.1	0.1	0.2	0.3	0.6	1.2	2.4	3.6	6.0	18.0	60.0	
OF50 Telephoto lens	50	1.5 m	13°	HFOV [m]				0.11	0.23	0.46	0.92	1.38	2.3	6.9	22.9	
			8°	VFOV [m]				0.07	0.14	0.29	0.58	0.86	1.4	4.3	14.4	
			15°	DFOV [m]				0.14	0.27	0.54	1.08	1.62	2.7	8.1	27.1	
			0.30 mrad	IIFOV [mm]				0.2	0.3	0.6	1.2	1.8	3.0	9.0	30.0	
OF75 Telephoto lens	75	2.0 m	9°	HFOV [m]				0.15	0.31	0.61	0.92	1.5	4.6	15.3		
			5°	VFOV [m]				0.10	0.19	0.38	0.58	1.0	2.9	9.6		
			10°	DFOV [m]				0.18	0.36	0.72	1.08	1.8	5.4	18.0		
			0.20 mrad	IIFOV [mm]				0.2	0.4	0.8	1.2	2.0	6.0	20.0		

¹The opris PI 05M is only available with OF25 lens and the opris PI 08M is available with OF16 and OF25 lens.

Microscope optics PI 640i	Focal length [mm]	Minimum measurement distance*	Angle	Distance to measurement object [m]			
				0.08	0.09	0.1	
MO44 Microscope optics	44.2	0.08 m	12°	HFOV [m]	0.018	0.021	0.023
			9°	VFOV [m]	0.014	0.016	0.017
			15°	DFOV [m]	0.023	0.026	0.029
			0.36 mrad	IIFOV [mm]	0.028	0.032	0.036

Microscope optics Xi 400	Focal length [mm]	Minimum measurement distance*	Angle	Distance to measurement object [m]			
				0.09	0.1	0.11	
F20 CF Microscope optics	20	0.09 m	18°	HFOV [m]	0.031	0.034	0.037
			14°	VFOV [m]	0.024	0.026	0.028
			23°	DFOV [m]	0.039	0.043	0.047
			0.9 mrad	IIFOV [mm]	0.08	0.09	0.10

PI 1M / PI 08M / PI 05M	Focal length [mm]	Minimum measurement distance*	Angle	Distance to measurement object [m]												
				0.1	0.2	0.3	0.5	1	2	4	6	10	30	100		
OF16 Wide angle lens	16	0.2 m	20°	HFOV [m]		0.07	0.11	0.18	0.36	0.72	1.43	2.15	3.6	10.7	35.8	
			15°	VFOV [m]		0.05	0.08	0.14	0.27	0.54	1.08	1.62	2.7	8.1	27.0	
			25°	DFOV [m]		0.09	0.13	0.22	0.45	0.90	1.79	2.69	4.5	13.5	44.9	
			0.94 mrad	IIFOV [mm]		0.2	0.3	0.5	0.9	1.9	3.8	5.6	9.4	28.1	93.8	
OF25 Standard lens	25	0.5 m	13°	HFOV [m]	0.023	0.05	0.07	0.11	0.23	0.46	0.92	1.38	2.3	6.9	22.9	
			10°	VFOV [m]	0.017	0.03	0.05	0.09	0.17	0.35	0.69	1.04	1.7	5.2	17.3	
			16°	DFOV [m]	0.029	0.06	0.09	0.14	0.29	0.57	1.15	1.72	2.9	8.6	28.7	
			0.60 mrad	IIFOV [mm]	0.1	0.1	0.2	0.3	0.6	1.2	2.4	3.6	6.0	18.0	60.0	
OF50 Telephoto lens	50	1.5 m	7°	HFOV [m]				0.06	0.11	0.23	0.46	0.69	1.1	3.4	11.5	
			5°	VFOV [m]				0.04	0.09	0.17	0.35	0.52	0.9	2.6	8.6	
			8°	DFOV [m]				0.07	0.14	0.29	0.57	0.86	1.4	4.3	14.4	
			0.30 mrad	IIFOV [mm]				0.2	0.3	0.6	1.2	1.8	3.0	9.0	30.0	
OF75 Telephoto lens	75	2.0 m	4°	HFOV [m]				0.08	0.15	0.31	0.46	0.8	2.3	7.6		
			3°	VFOV [m]				0.06	0.12	0.23	0.35	0.6	1.7	5.8		
			5°	DFOV [m]				0.10	0.19	0.38	0.57	1.0	2.9	9.6		
			0.20 mrad	IIFOV [mm]				0.2	0.4	0.8	1.2	2.0	6.0	20.0		

Table with examples showing which measurement field sizes and pixel sizes will be reached at which distance. For optimal configuration of the camera there are various lenses available. Wide angle lenses have radial distortion due to the angle of their aperture. The PIX Connect software has an algorithm which corrects this distortion.

*Please note: Please use the optics calculator on our website in order to calculate measurement fields with shorter measurement distances:

www.optris.com/en/optris-calculator

The measurement accuracy of the camera may lie outside of the specifications for distances below the defined minimum measurement distance.

¹The opris PI 05M is only available with OF25 lens and the opris PI 08M is available with OF16 and OF25 lens.

 [linkedin.com/company/optris](https://www.linkedin.com/company/optris)

 [youtube.com/@Optris](https://www.youtube.com/@Optris)

 twitter.com/optris

 [facebook.com/optris.gmbh](https://www.facebook.com/optris.gmbh)

when temperature matters

Optris GmbH
Ferdinand-Buisson-Str. 14
13127 Berlin · Germany

Phone: +49 30 500 197-0
Fax: +49 30 500 197-10
E-mail: info@optris.com
www.optris.com

